

ULTIMATE SUPPORT®











OVER
40
YEARS
OF INNOVATION

2019 CATALOG Q1



MAIN MENU

[CLICK ON PRODUCT LINKS](#)

	STUDIO FURNITURE	3
	KEYBOARD STANDS (NEW PRODUCTS!)	9
	GUITAR STANDS	13
	GUITAR HANGER	15
	AMPLIFIER STANDS	15
	SPEAKER STANDS	17
	SPEAKER POLES	21
	LIGHTING TREES	22
	MICROPHONE STANDS & BOOMS	24
	MONITOR STANDS	30
	LAPTOP MOUNTS & STANDS	32

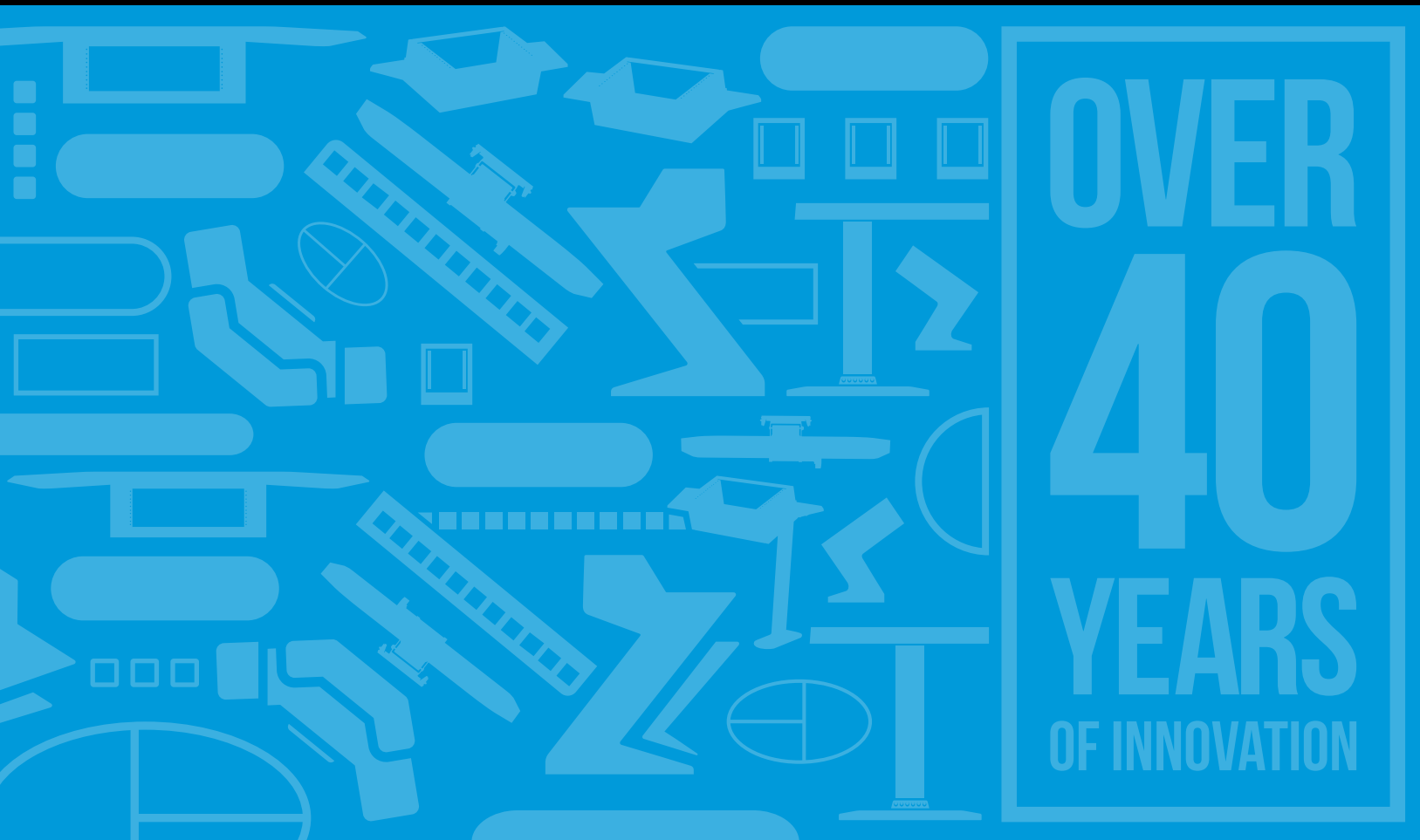

PROFESSIONAL STUDIO FURNITURE NEW!

[CLICK ON PRODUCT LINKS](#)

NUCLEUS SERIES P.4-6

NUC-001
NUC-002
NUC-003
NUC-004
NUC-005

NUCLEUS SERIES MODULAR PARTS P.6-7

NUC-TR2
NUC-KB1
NUC-R04
NUC-EX24L
NUC-EX24R
NUC-R12L
NUC-R12R

NUCLEUS SERIES DESKTOP DEVICE STAND P.7

MDS-100
MDS-X Expander

STUDIO DESK ACCESSORIES P.7

Lights
Lights
NUC-MM1
NUC-MM2

NUCLEUS Z SERIES P.8

NUC-Z-NAV

NUCLEUS Z SERIES MODULAR PARTS P.8

NUC-Z-RCK
NUC-Z-KBD
NUC-Z-BDM



ULTIMATE STUDIO FURNITURE NUCLEUS SERIES

NUC-001, item #18100

Modular Studio Desk - Base Model,
12" Extensions

Specs:

- Overall Width: 84.8"
- Overall Depth: 36"
- Overall Height: 29.5"
- Main Worksurface Depth: 24"
- Main Worksurface Height: 29.5"
- Weight: 87.5 lbs.

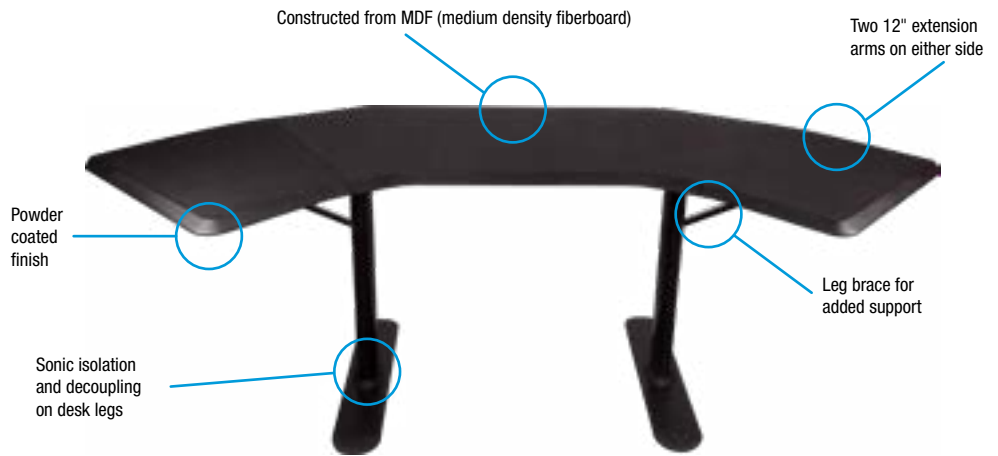

NUC-002, item #18101

Modular Studio Desk - Expanded
Base Model, 12" Extensions, 2nd
Tier, Keyboard Tray

Specs:

- Overall Width: 84.82"
- Overall Depth: 44"
- Overall Height: 39.29"
- Main Worksurface Depth: 24"
- Main Worksurface Height: 29.5"
- Second Tier Worksurface Depth: 12.12"
- Second Tier Worksurface Width: 58.16"
- Leveler Adjustment: .625"
- Keyboard Surface Width: 30.60"
- Keyboard Surface Depth: 9.76"
- Keyboard Surface Travel: 17.7"
- Weight: 137.5 lbs.

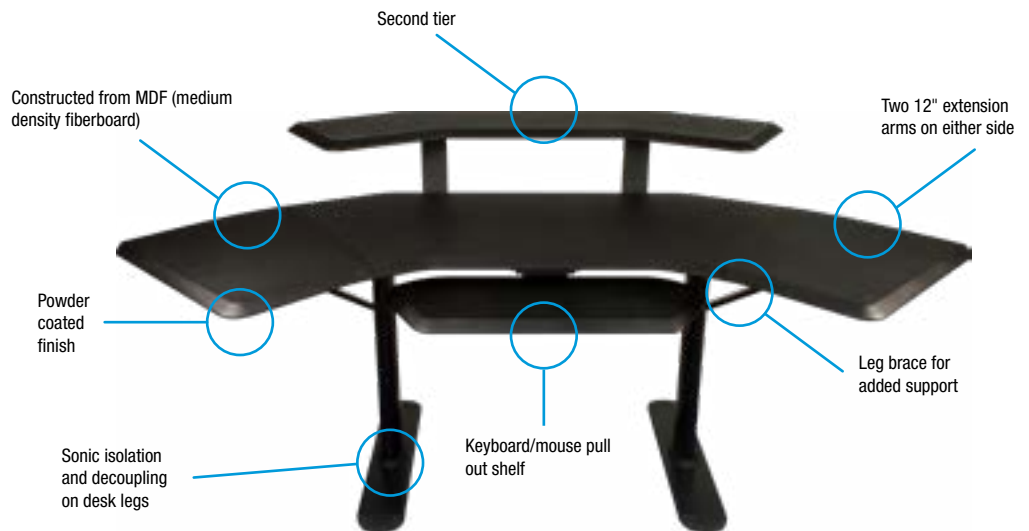



ULTIMATE STUDIO FURNITURE NUCLEUS SERIES

NUC-003, item #18102

Modular Studio Desk - Advanced Model,
24" Extensions, 12 Space Rack, 2nd Tier,
Keyboard Tray

Specs:

- Overall Width: 101.79"
- Overall Depth: 65.3"
- Overall Height: 39.29"
- Main Worksurface Depth: 24"
- Main Worksurface Height: 29.5"
- Second Tier Worksurface Depth: 12.12"
- Second Tier Worksurface Width: 58.16"
- Leveler Adjustment: .625"
- Keyboard Surface Width: 30.60"
- Keyboard Surface Depth: 9.76"
- Keyboard Surface Travel: 17.7"
- 19" Rack Cabinets: 1
- Total Rack Cabinet Spaces: 12
- Weight: 204.75 lbs.

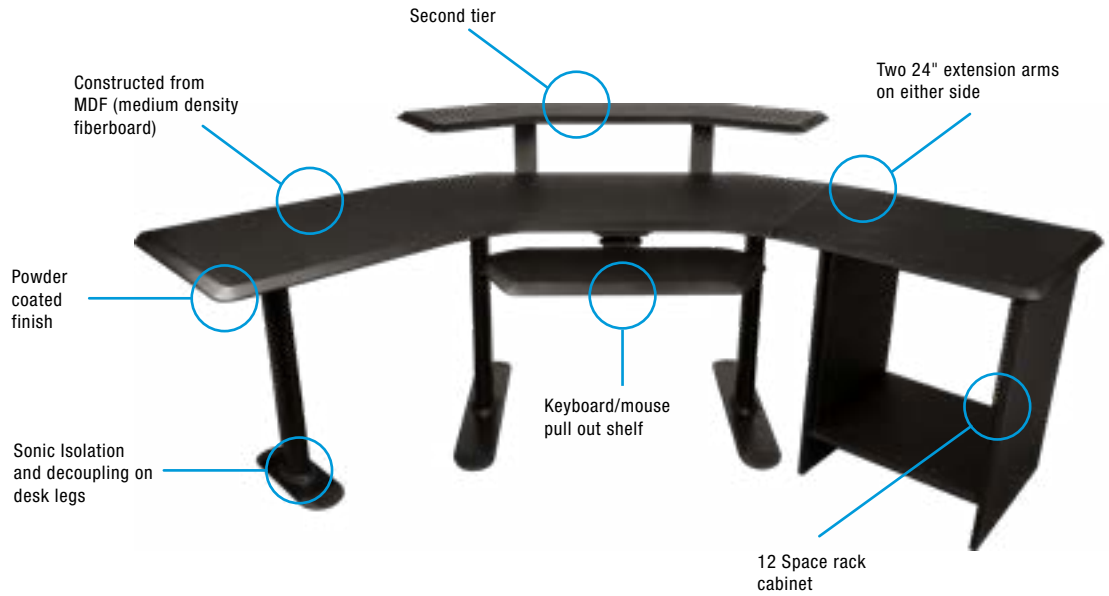

NUC-004, item #18109

Modular Studio Desk - Advanced Model
Expanded, 24" Extension, 12 Space
Rack, 2nd Tier, 4 Space Rack, Keyboard
Tray

Specs:

- Overall Width: 101.79"
- Overall Depth: 65.3"
- Overall Height: 39.29"
- Main Worksurface Depth: 24"
- Main Worksurface Height: 29.5"
- Second Tier Worksurface Depth: 12.12"
- Second Tier Worksurface Width: 58.16"
- Leveler Adjustment: .625"
- Keyboard Surface Width: 30.60"
- Keyboard Surface Depth: 9.76"
- Keyboard Surface Travel: 17.7"
- 19" Rack Cabinets: 2
- Total Rack Cabinet Spaces: 16
- Weight: 219.75 lbs.

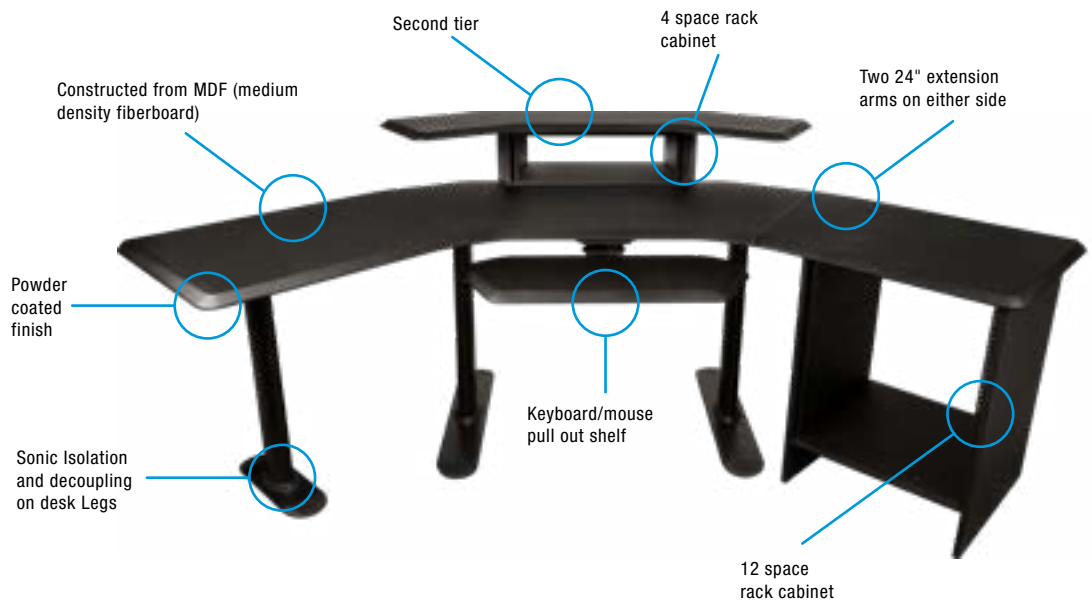



ULTIMATE STUDIO FURNITURE NUCLEUS SERIES

**NOW
SHIPPING**

NUC-005, item #18117

Modular Studio Desk - Advanced Model
Expanded, 24" Extension,
two 6 RU Desk Mounted Bays, 2nd Tier, 4
Space Rack, Keyboard Tray

Specs:

- Overall Width: 101.79"
- Overall Depth: 65.3"
- Overall Height: 39.29"
- Main Worksurface Depth: 24"
- Main Worksurface Height: 29.5"
- Second Tier Worksurface Depth: 12.12"
- Second Tier Worksurface Width: 58.16"
- Leveler Adjustment: .625"
- Keyboard Surface Width: 30.60"
- Keyboard Surface Depth: 9.76"
- Keyboard Surface Travel: 17.7"
- 19" Rack Cabinets: 3
- Total Rack Cabinet Spaces: 16
- Weight: 198.26lbs. (89.93 kg)

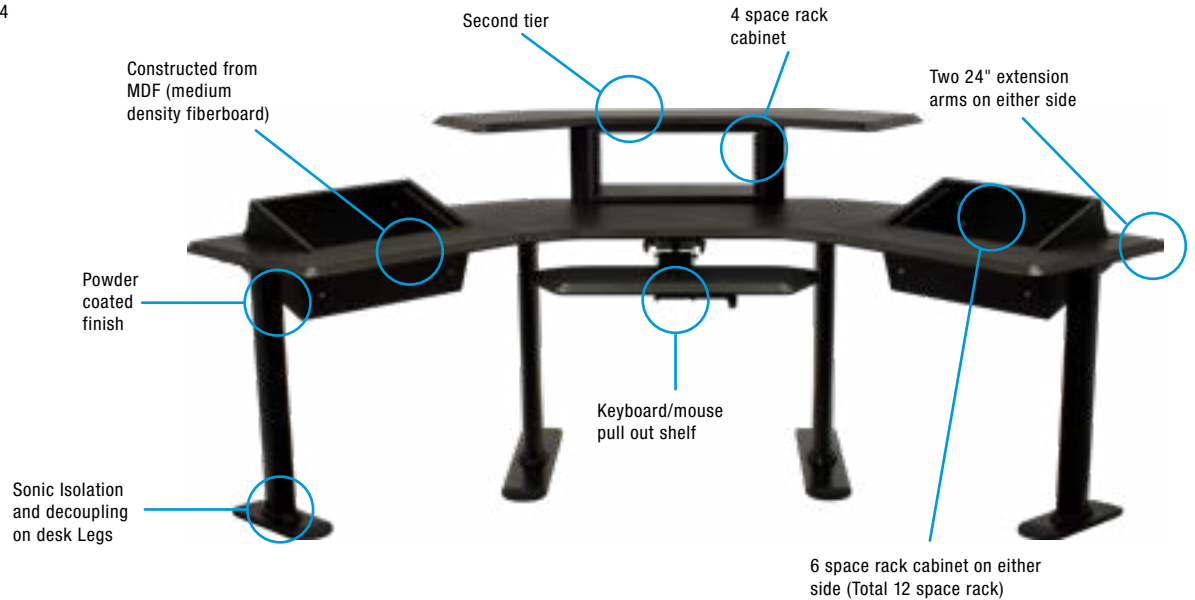

NUCLEUS SERIES MODULAR PARTS

NUC-TR2, item #18106

Nucleus Series 2nd Tier

Specs:

- Width: 58.25"
- Height: 4"
- Depth: 18.39"
- Weight: 24 lbs.



NUC-KB1, item #18105

Nucleus Series Keyboard Tray

Specs:

- Width: 30.79"
- Height: 5"
- Depth: 9.76"
- Keyboard Travel: 17.7"
- Weight: 12.55 lbs.



NUC-R04, item #18103

Nucleus Series - Studio Desk - 4 Space
Rack (Works with 2nd Tier)

Specs:

- Width: 20.65"
- Height: 8.75"
- Depth: 12"
- Weight: 13 lbs.





ULTIMATE STUDIO FURNITURE NUCLEUS SERIES MODULAR PARTS

NUC-EX24L, item #18112

NUC-EX24R, item #18111

Nucleus Series - Studio Desk Table Top - Single 24" Extension with Leg

Specs:

- Width: 32.73"
- Height: 29.5"
- Depth: 24"
- Weight: 24.68 lbs.



NUC-R12L, item #18110

NUC-R12R, item #18104

Nucleus Series - Studio Desk Table Top - Single 24" Extension with 12 Space Rack

Specs:

- Width: 32.73"
- Height: 29.5"
- Depth: 24"
- Weight: 55 lbs.



NUC-R6L, item #18118

NUC-R6R, item #18119

Nucleus Series - Studio Desk Table Top - Single 24" Extension with 6 RU Desk Mounted Bays

Specs:

- Width: 32.73"
- Height: 29.5"
- Depth: 24"
- Weight: 29.1lbs (13.2 kg) lbs.



NOW SHIPPING

DESKTOP DEVICE STAND

NOW SHIPPING

MDS-100
item #17983

Desktop Device Stand for Tabletop Synthesizers, Drum Machines, Effects Pedals, and Other Devices

Specs:

- Width - 18.83" (478.40mm)
- Depth - 7.82" (198.62mm)
- Height - 5.55" (140.94mm)
- Clamping Surface Depth - 8.34" (211.9mm)
- Clamping Surface Max Area - 133.27 sq. in. (85980.47 sq. mm)
- Clamping Width Range (w/o divider) - 6.41" (162.9mm) - 15.98" (405.9mm)
- Clamping Width Range (with divider, each side) - 2.84" (72.1mm) - 7.62" (193.59mm)
- Clamp Height - .91" (23mm)
- Weight - 2.8lbs. (1.3 kg)

Removable Center Dividing Wall for side by side devices.



Adjustable side walls can retract and expand.



Optional expander allows one to stack two MDS-100 Stands on top of each other.

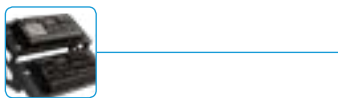

MDS ACCESSORY

NOW SHIPPING

MDS-X Expander
item #17984

Expander Kit for Desktop Device Stand (Need Two MDS-100 to Configure)

Specs:

- Height - 12.26" (311.34mm)
- Depth - 13.91" (353.29mm)
- Width - 18.83" (478.40mm)
- Expander Weight: 0.6lbs. (.27 kg)
- Assembled Weight: 6.2lbs. (2.8 kg)



MDS-100 Stands Not Included



STUDIO DESK ACCESSORIES

NUC-MM1, item# 18107

The Flexible and Sturdy Monitor Mount (Single)



NUC-MM2, item# 18108

The Flexible and Sturdy Monitor Mount (Double)



NUC-Z-LED-S, item# 18120

Nucleus-Z Strip Style LED Lighting Kit for Nucleus-Z Desks





ULTIMATE STUDIO FURNITURE NUCLEUS Z SERIES

NUC-Z-NAV, item# 18116

Modular Studio Desk - Fully Expanded Z Desk, 8 Space Rack Cabinet, Keyboard Shelf, Desk with Two 4 Space Rack Shelves

Specs:

- Overall Width: 64.50"
- Overall Depth: 28"
- Overall Height: 40.4"
- Main Worksurface Depth: 23.5"
- Keyboard Worksurface Depth: 18"
- Secondary Surface Depth: 12"
- Desk Leveler Adjustment: 1"
- Rack Cabinet Leveler Adjustment: .625"
- 19" Rack Cabinets: 3
- Total Rack Cabinet Spaces: 16
- Main Worksurface Height: 34.125"
- Weight: 136 lbs.



Constructed from
MDF (medium
density fiberboard)

Powder coated finish

NUCLEUS Z SERIES MODULAR PARTS



NUC-Z-RCK, item# 18115
Rack Cabinet (8 space)



NUC-Z-KBD, item# 18114
Keyboard Shelf



NUC-Z-BDM, item# 18113
Desk with Shelf and Two (2) - 4
Space Rack Modules

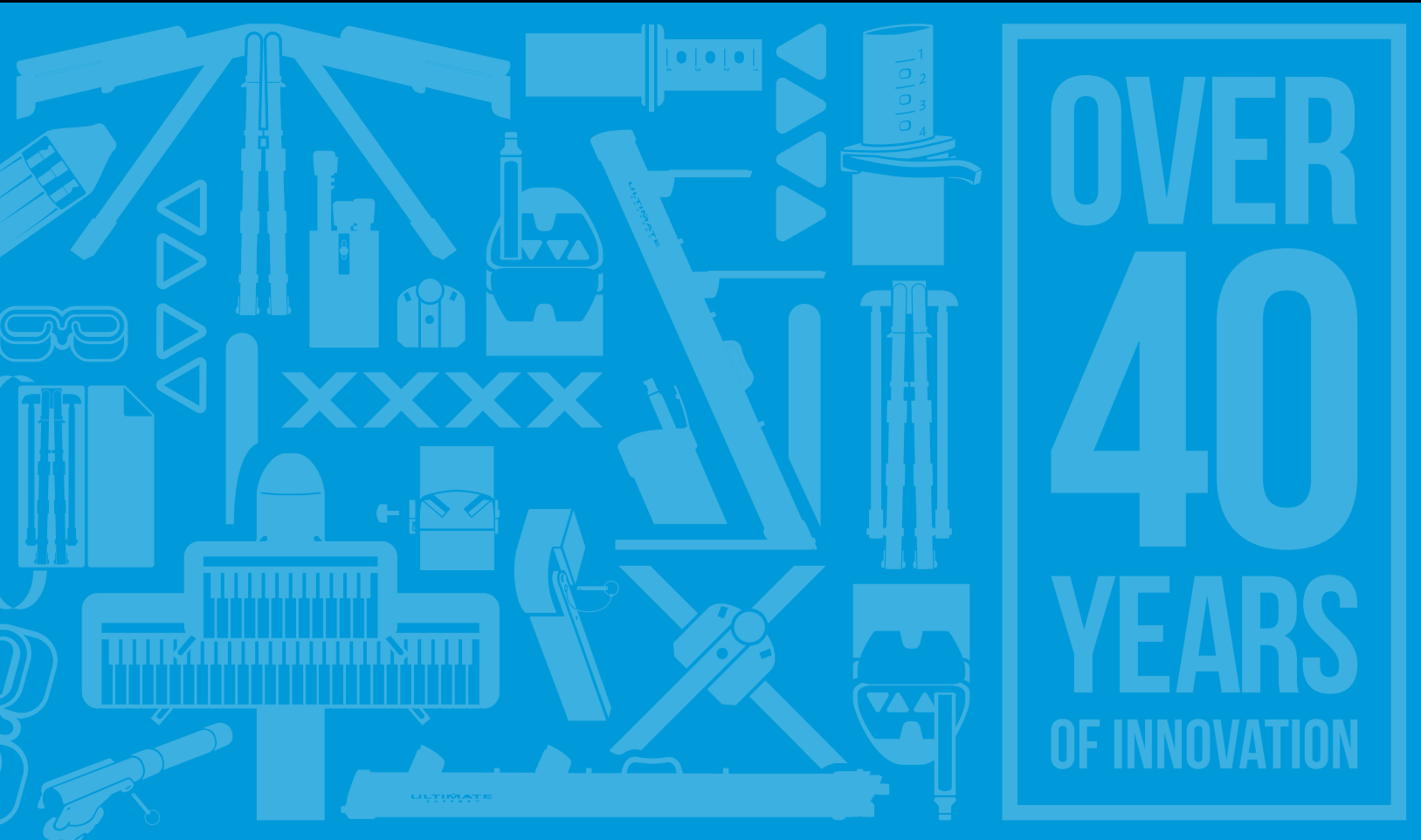

OVER
40
YEARS
OF INNOVATION

PROFESSIONAL KEYBOARD STANDS

[CLICK ON PRODUCT LINKS](#)

APEX® SERIES P. 10-11

- AX-1, Black
- AX-48B Pro, Black
- AX-48B Pro Plus, Black
- AX-48S Pro, Sliver

DELTEX™ SERIES P. 11

- DX-48B Pro, Black

V-STAND® PRO SERIES P. 11

- VS-88B

IQ SERIES® P. 12

- IQ-X-3000
- IQ-X-2000
- IQ-X-1000

ACCESSORIES P. 12

- HYM-100QR
- AX-48 Pro Mic
- AX-48 Pro Bag
- AX-1-PB
- VSIQ-200
- IQ-X-200

APEX ONE TWO TIERED COLUMN KEYBOARD STAND

SHIPPING
END OF
Q2

The Apex Series from Ultimate Support is easily one of the most popular and iconic keyboard stands in the world. The Apex One builds on our previous refinements of the design from the AX-48 Pro, and improves upon them. The new design features an updated tier design that folds back into the column – making this our most portable Apex yet. In addition, if you have old Apex accessories, the old CMP-485 tier accessory still can be added to the column for additional tiers, and the tribars for two sets of arms can still store in the column. The new Apex One- it's everything you love about Apex Stands, made even better.

AX-1 NEW!

Apex One Specs

- Part Name: AX-1
- Part Number: 18560
- Color: Black
- Height: 46"
- Weight: 23.91 lbs.
- Footprint Radius: 18.8" x 36.5"
- Folded Length: 52"
- Load Capacity:
Up to 125 lbs. Per Tier
or 250 lbs. Total

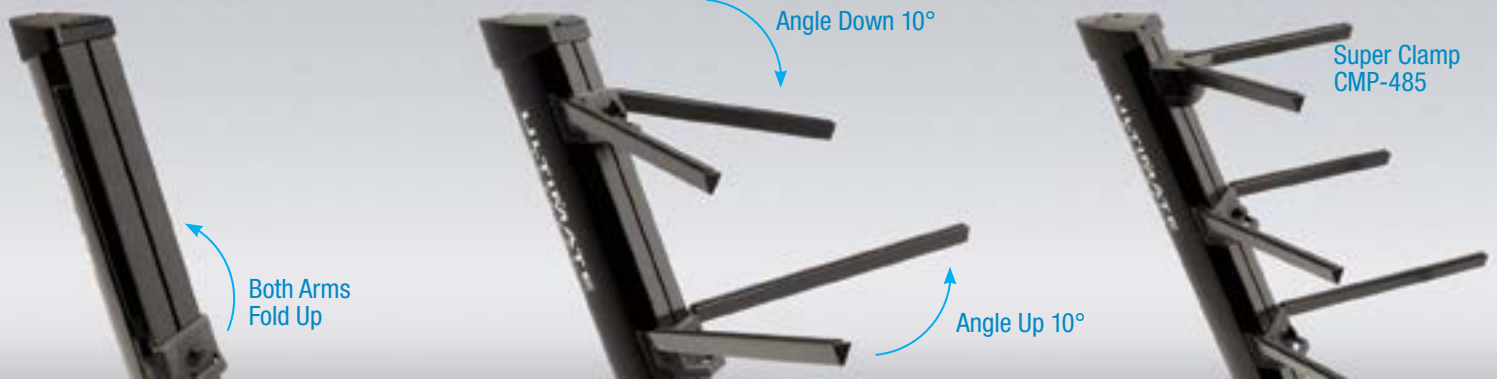

ENHANCED PORTABILITY

The Apex One's built-in tiers can be adjusted to place where you need them on the column, and they fold back into the column for transport and storage.

ADJUSTABLE ARMS

The arms on the Apex One's built in tiers can be set at three different angles, providing a completely level surface, or the option to angle tiers up or down.

BACKWARDS COMPATIBILITY

Your old accessories will still work with the Apex One! Old Super Clamps still attach to the column, and old tribar arms still store inside!



LEVELING FEET FOR UNEVEN SURFACES

The Apex One features two leveling feet for placing on uneven surfaces. The utility you want, for the security you need!

HAPPY FEET

Specially angled support legs have been designed to open up floor space and leave you room for pedals.



PROFESSIONAL KEYBOARD STANDS

APEX® SERIES

APEX® AX-48 Pro B, item #17351

APEX® Series Professional Column Keyboard Stand with 13" and 18" Tri-bar Support Arms – Black

Specs:

- Height: 46" (1168mm)
- Weight: 19 lbs. (8.6 kg)
- Folded Length: 52" (1321mm)
- Load Capacity: Up to 125 lbs. per tier (56.8 kg) or 250 lbs. total (113.6 kg)

New top cap w/ professional piano-style hinge.



Height-adjustable arms hold up to 125 lbs. each.



Cable management system.



Arms and legs store inside column.

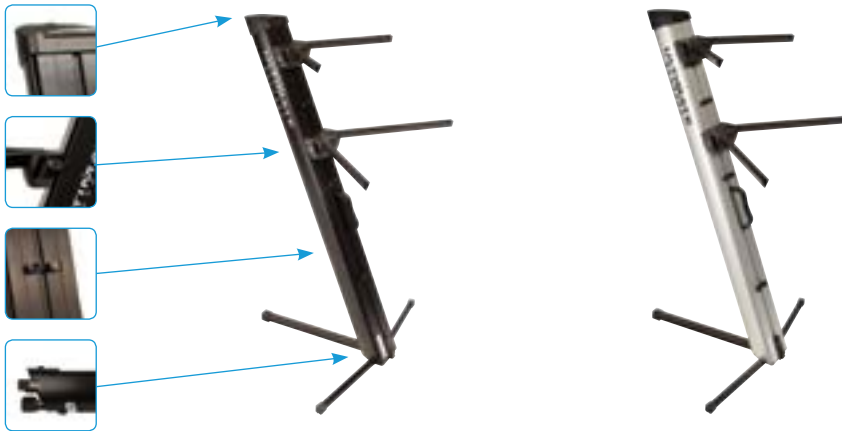

APEX® AX-48 Pro S, item #17476

APEX® Series Professional Column Keyboard Stand with 13" and 18" Tri-bar Support Arms – Silver

Specs:

- Height: 46" (1168mm)
- Weight: 19 lbs. (8.6 kg)
- Folded Length: 52" (1321mm)
- Load Capacity: Up to 125 lbs. per tier (56.8 kg) or 250 lbs. total (113.6 kg)

APEX® AX-48 PRO Plus, item 17368

APEX® Column Keyboard Stand Bundle with Microphone Boom and Tote Bag – Black

Included with This Bundle:

- AX-48 Pro Column Keyboard Stand (Black)
- Ulti-Boom Telescoping Mic Boom Arm
- AX-48 Pro Boom Adapter
- AX-48 Pro Tote Bag



BAG & BOOM INCLUDED!

DELTEX™ PRO SERIES

Deltex™ DX-48 Pro B, item #17908

Deltex™ Series Professional Compact Column Keyboard Stand with 13" Tri-bar Support Arms – Black

Specs:

- Standing Height: 45.5" (1156mm)
- Weight: 14 lbs. (6.4 kg)
- Folded Length: 49.5" (1257mm)
- Load Capacity: 75 lbs. (34 kg)

Integrated mic mount holds booms and accessories.



Stand holds up to 75 lbs.



Bag holds the support arms and foot bar.



BAG INCLUDED!

V-STAND® PRO SERIES

V-Stand® Pro, Item #17479

Professional V-Style Height-adjustable Keyboard Stand

V-Stand Pro Features:

- Height: 27" - 40.75" (656mm - 1035mm)
- Arms Depth: 17" (432mm)
- Legs Depth: 24" (610mm)
- Arms Width: 19.5"-29" (495mm-737mm)
- Legs Width: 38" (965mm)
- Folded Dimensions: 28.5" x 9.5" x 6" (724mm x 241mm x 152mm)
- Weight: 18.25 lbs. (464mm)
- Load Capacity: 150 lbs. (68 kg)

Heavy-walled support arms.



Height-adjustable legs for sitting or standing.



Floor supports lock in position.



Ultra compact when folded

BAG INCLUDED!



PROFESSIONAL KEYBOARD STANDS

IQ SERIES®

IQ-X-3000, item #18532

IQ Series® X-style Keyboard Stand with Patented Memory Lock, Nine Height Settings, Stabilizing End Caps, and Extra-strength Tubing - 300 lbs. Capacity

Specs:

- Height: 20" - 36" (508mm - 914mm)
- Width: 18" - 34.5" (457mm - 876mm)
- Arm Length: 16" (406mm)
- Leg Length: 22.25" (565mm)
- Weight: 18 lbs. (8 kg)
- Load Capacity: 300 lbs. (136.1 kg) distributed

SHIPPING
Q2

IQ-X-2000, item #18531

IQ Series® X-style Keyboard Stand with Patented Memory Lock, Five Height Settings, Stabilizing End Caps, and Double-braced Tubing - 150 lbs. Capacity

Specs:

- Height: 22" - 36" (559mm - 914mm)
- Width: 18.5" - 33" (469mm - 838mm)
- Arm Length: 13.75" (349mm)
- Leg Length: 20" (508mm)
- Weight: 12 lbs. (5.5 kg)
- Load Capacity: 150 lbs. (68.2 kg) distributed

SHIPPING
Q2

IQ-X-1000, item #18530

IQ Series® X-style Keyboard Stand with Patented Memory Lock System, Five Height Settings, Stabilizing End Caps, and Single-braced Tubing - 100 lbs. Capacity

Specs:

- Height: 22" - 36" (559mm - 914mm)
- Width: 18.5" - 33" (469mm - 838mm)
- Arm Length: 13.75" (349mm)
- Leg Length: 20" (508mm)
- Weight: 8 lbs. (4 kg)
- Load Capacity: 100 lbs. (45.5 kg) distributed

SHIPPING
Q2

300 lbs. weight capacity for workstations, DJ gear, mixers, etc.



Patented Memory Lock system with nine height positions.



Stabilizing end caps overcome uneven surfaces.

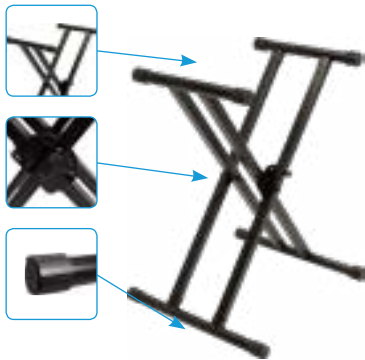

Unprecedented strength in a lightweight design.



Patented Memory Lock system with five height positions.

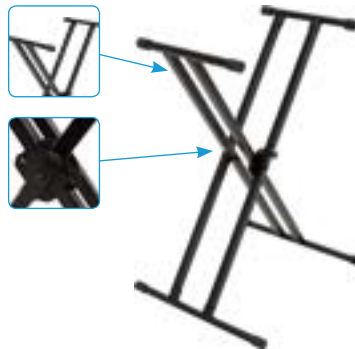

Patented Memory Lock system with five height positions.



Extra knee and foot room built into every IQ-1000!

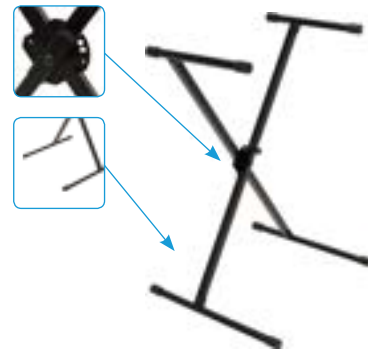

KEYBOARD STAND ACCESSORIES

SEE
PAGE 33



AX-48 Pro Bag, item #17367

Tote Bag for Use with AX-48 Pro Keyboard Stand



HYM-100QR, item # 17511

Dynamic laptop stand that mounts to an Apex or Deltex keyboard Stand (Keyboard stand needs a 5/8 threaded adapter)



AX-48 Pro Mic, item #17366

Microphone Boom Arm Adapter and Ulti-Boom for Use with AX-48 Pro Keyboard Stand

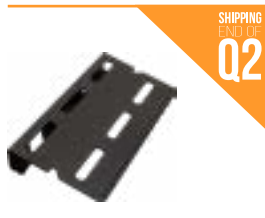

SHIPPING
END OF
Q2

Add to your APEX ONE Stand.

AX-1-PB, item # 18561

Pedalboard for Apex One Keyboard Stand

- Height: 2.33" (259mm)
- Depth: 7.62" (194mm)
- Width: 15.75" (400mm)



Add to your VS-88B or IQ-3000.

VSQI-200B, item #17909

Professional Second Tier for V-Stand® Pro and IQ-3000 Keyboard Stands

- Load capacity: 50 lbs. (23 kg)



SHIPPING
Q2

Add to your IQ-1000 IQ-X-1000, IQ-2000 or IQ-X-2000.

IQ-X-200, item #18533

Second Tier for Ultimate Support IQ-X-2000 and IQ-X-1000 Keyboard Stands

- Fits Tubing: .788-1" Diameter
- Load capacity: 50 lbs. (23 kg)

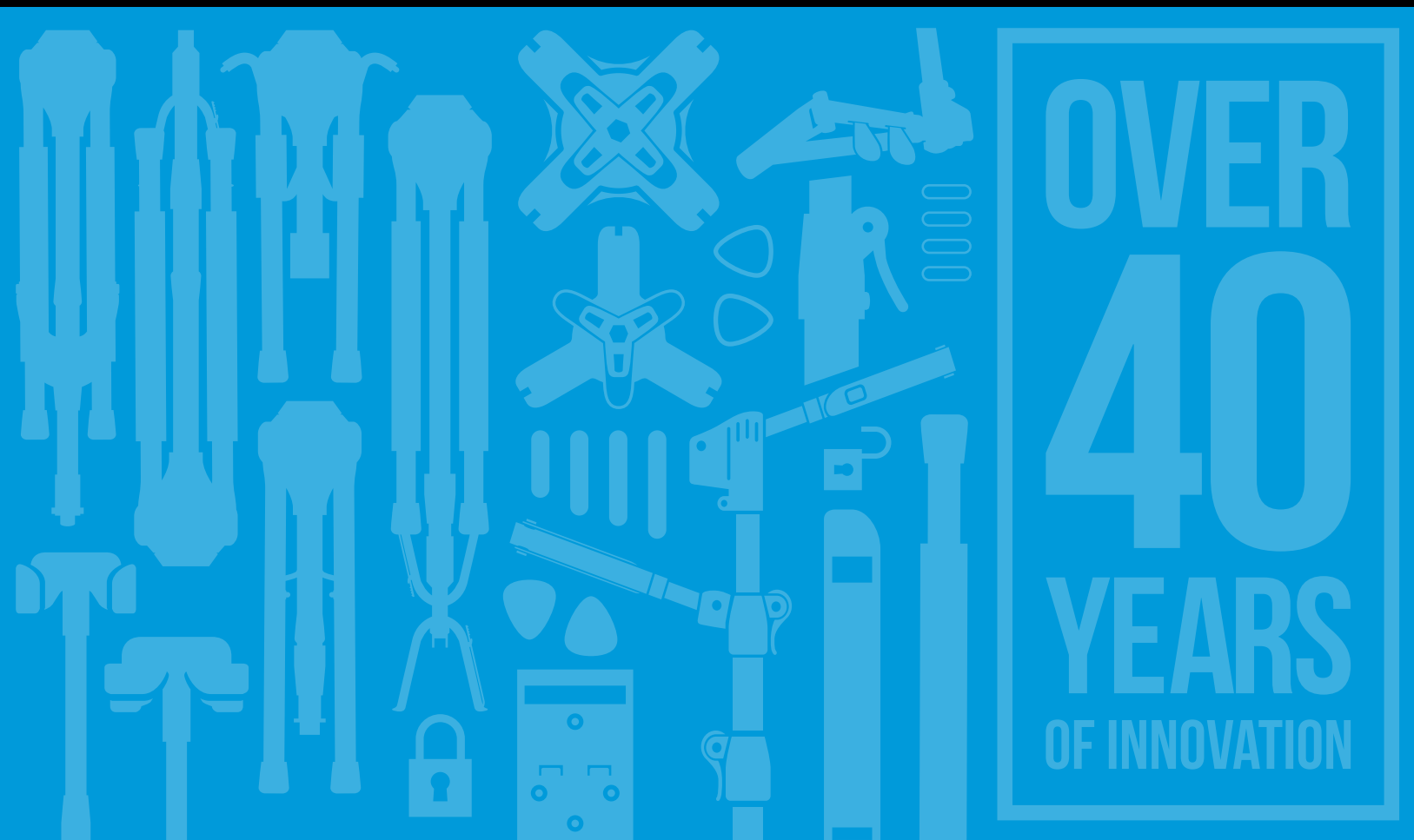

PROFESSIONAL GUITAR STANDS, AMP STAND, & GUITAR HANGERS

[CLICK ON PRODUCT LINKS](#)

GUITAR STANDS P. 14-15

GS-102
GS-1000 Pro
GS-100
GS-200
GS-55

AMP STAND P. 15

AMP-150

GUITAR HANGER P. 15

GS-10 Pro



GENESIS® SERIES PROFESSIONAL GUITAR STANDS

GUITAR STANDS

GS-102, item #17602

Height-adjustable Genesis® Series Double Guitar Stand with Locking Legs, Hanging-style Yokes and Security Straps

- Specs:**
- Security Gate: Safety Strap
 - Fixed Cradle Height: 33.7" - 46.1" (856mm - 1170.9mm)
 - Adjustable Cradle Height: 32.2" - 44.5" (817.8mm - 1130.3mm)
 - Folded Size: 3.8" x 27.5" (96.52mm x 698.5mm)
 - Weight: 4.80 lbs. (2.17kg)

Hanging-style yoke and safety strap secures guitar in place.



Quickly and easily adjust height.



Protective padding that won't inherently harm your guitar.



SHIPPING
END OF
Q1

Showing
Folded

GS-1000 Pro, item #17600

Height-adjustable Genesis® Series Guitar Stand with Locking Legs and Self-closing Yoke Security Gate

- Specs:**
- Set Up Height: 33.5" - 45.5" (838mm - 1156mm)
 - Weight: 3.5 lbs. (1.6 kg)
 - Folded Length: 3.5" x 21" (89mm x 533mm)

Weight-sensing yoke automatically closes to securely cradle your guitar.



Quickly and easily adjust height.



Legs lock in place when standing or folded.



Showing
Folded

GS-100, item #13710

Height-adjustable Genesis® Series Guitar Stand with Locking Legs, Hanging-style Yoke and Security Strap

- Specs:**
- Set Up Height: 33.5" - 45.5" (838mm - 1156mm)
 - Weight: 3.5 lbs. (1.6 kg)
 - Folded Length: 3.5" x 21" (89mm x 533mm)

Hanging-style yoke and safety strap secures guitar in place.



Quickly and easily adjust height.



Protective padding that won't inherently harm your guitar.



Showing
Folded

GS-200, item #13711

Genesis® Series Guitar Stand with Locking Legs, Secure Headstock Yoke Security Gate and Support Arms

- Specs:**
- Set Up Height: 32" (813mm)
 - Weight: 3.1 lbs. (1.4 kg)
 - Folded: 3.5" x 21" (89mm x 533mm)

Hanging-style yoke and safety strap secures guitar in place.



Support arms offer more traditional support of lower bout.

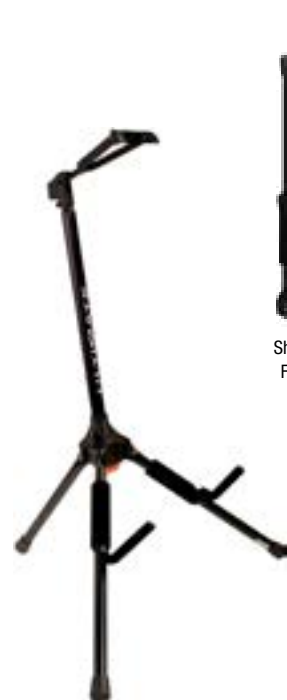

Showing
Folded



GENESIS® SERIES PROFESSIONAL GUITAR STAND, GUITAR HANGER & AMP STAND

GUITAR STANDS

GS-55, item #17350
Ultra Compact, A-Frame Style Genesis® Series Guitar Stand with Locking Legs

- Specs:**
- Set Up Height: 12.25" (311mm)
 - Weight: 1.5 lbs. (.71 kg)
 - Folded: 3.5" x 14" (89mm x 356mm)

Keep extra picks nearby with handy storage slots.



Stable A-Frame design holds acoustic or electric guitars.



Showing Folded

GS-10 PRO, item #17601
Genesis® Series Adjustable Professional Guitar Hanger with Self-Closing Security Gates – Slatwall & Wall Mount

- Specs:**
- Wall-to-Headstock Depth: 7.75"-10.5" (196.8mm - 266.7mm)
 - Adjustable Angle: Sweepable 180 Degrees
 - Weight: 1 lbs. (0.5)

3" and 4" slatwall adapter. Also, Drywall adapter included.



Depth and angle adjustable



Self-closing security gates



AMP STAND



AMP-150, item #13464
Ultra Compact, Three-position Tilt, Genesis® Series Amp Stand with Locking Legs and Mic Boom Attachment

- Specs:**
- Set Up Height: 17.5" - 21.5" (444mm - 546mm)
 - Weight: 3.1 lbs. (1.4 kg)
 - Folded: 3.5" x 18" (89mm - 457mm)
 - Load Capacity: 75 lbs. (34 kg)

Height adjustable to fit most combo amps.



Three tilt positions direct the amp's sound to your ears.



Showing Folded



Mic Boom Not Included
Never bring an extra mic stand to the gig again! Just add your boom arm and mic to the AMP-150.

**OVER
40
YEARS
OF INNOVATION**

PROFESSIONAL SPEAKER STANDS

[CLICK ON PRODUCT LINKS](#)

AIR-POWERED SERIES P. 17

TS-110BL

TS-110B

TS-100B

TELELOCK® SERIES P. 18

TS-99BL

TS-99B

TS-90B

ORIGINAL SERIES P. 19

TS-88B

TS-80B

TS-80S

CLASSIC SERIES P. 19

TS-70B

SPEAKER POLES P. 20

SP-80

SP-90

SP-100

ACCESSORIES P. 20

Bag-90

Bag-90D

Bag-99

Bag-99D

BMB-200K

TSM-150MK

TSM-138MK

Speaker Stand Covers



PROFESSIONAL SPEAKER STANDS

AIR-POWERED SERIES



Air-Powered Series speaker stands from Ultimate Support represent everything all other speaker stands aspire to be. They're incredibly strong, extraordinarily sturdy, lightweight, and raise and lower speakers on their own! Driven by innovation and years of research and development, the Air-Powered Series features an internal shock that lifts speakers weighing 35 lbs and less with no effort, and requires very little end-user effort to raise speakers weighing more than 35 lbs!

TS-100B, item #16759

Air-Powered Series Lift-assist Aluminum Tripod Speaker Stand with Integrated Speaker Adapter.

Specs:

- Height: 3'8" - 6'7" (1118mm - 2007mm)
- Weight: 12.1 lbs. (5.5 kg)
- Base Diameter: 47" (1194mm)
- Telescoping Tube Diameter: 1.5" (38mm)
- Adapter Diameter: 1.375" (35mm)
- Load Capacity: 150 lbs. (68.2 kg)
- Folded: 43.5" x 5.5" (1105mm x 140mm)

TS-110B, item #17356

Air-Powered Series Lift-assist Aluminum Tripod Speaker Stand with Integrated Speaker Adapter - Extra Tall Height

Specs:

- Height: 5'2" - 9'2" (1575mm - 2794mm)
- Weight: 13.1 lbs. (5.5 kg)
- Base Diameter: 62" (1575mm)
- Telescoping Tube Diameter: 1.5" (38mm)
- Adapter Diameter: 1.375" (35mm)
- Load Capacity: 150 lbs. (68.2 kg)
- Folded: 57.5" x 5.5" (1461mm x 140mm)

TS-110BL, item #17357

Air-Powered Series Lift-assist Aluminum Tripod Speaker Stand with Integrated Speaker Adapter - Extra Tall Height and Leveling Leg

Specs:

- Height: 5'2" - 9'2" (1575mm - 2794mm)
- Weight: 13.5 lbs. (5.5 kg)
- Base Diameter: 62" (1575mm)
- Telescoping Tube Diameter: 1.5" (38mm)
- Leveling Leg Length: 40" - 53" (1016mm - 1346mm)
- Adapter Diameter: 1.375" (35mm)
- Load Capacity: 150 lbs. (68.2 kg)
- Folded: 57.5" x 6" (1461mm x 152mm)

Oversized, heavy wall aluminum tubing for strength and portability.

Internal air-powered shock gently raises and lowers the speaker for you.

Patented tripod design and glass-reinforced fittings and collars for gig-worthy strength.





PROFESSIONAL SPEAKER STANDS

TELELOCK® SERIES



TeleLock® Series speaker stands are some of the easiest speaker stands to use thanks to the patented TeleLock® collar. Set the TeleLock® collar to the “Raise” setting and the Auto-lock technology provides just the right amount of resistance to lock the telescoping pole in place while you adjust the height of your speaker. Set it to the “Lower” setting and gently guide your speaker down. Set it to the “Lock” setting and the speaker will securely lock in place. Owning and using TeleLock® speaker stands is like having tour support built into every show!

TS-90B, item #13908

TeleLock® Series Lift-assist Aluminum Speaker Stand with Integrated Speaker Adapter

Specs:

- Height: 3'8" - 6'7" (1118mm - 2007mm)
- Weight: 7.3 lbs. (3.3 kg)
- Base Diameter: 47" (1194mm)
- Telescoping Tube Diameter: 1.5" (38mm)
- Adapter Diameter: 1.375" (35mm)
- Load Capacity: 150 lbs. (68.2 kg)
- Folded: 43.5" x 5.5" (1105mm x 140mm)

TS-99B, item #13910

TeleLock® Series Lift-assist Aluminum Speaker Stand with Integrated Speaker Adapter - Extra Tall Height

Specs:

- Height: 5'2" - 9'2" (1575mm - 2794mm)
- Weight: 9.8 lbs. (4.5 kg)
- Base Diameter: 62" (1575mm)
- Telescoping Tube Diameter: 1.5" (38mm)
- Adapter Diameter: 1.375" (35mm)
- Load Capacity: 150 lbs. (68.2 kg)
- Folded: 57.5" x 5.5" (1461mm x 140mm)

TS-99BL, item #13642

TeleLock® Series Lift-assist Aluminum Speaker Stand with Integrated Speaker Adapter - Extra Tall Height and Leveling Leg

Specs:

- Height: 5'2" - 9'2" (1575mm - 2794mm)
- Weight: 10.2 lbs. (4.5 kg)
- Base Diameter: 62" (1575mm)
- Telescoping Tube Diameter: 1.5" (38mm)
- Leveling-leg length 40" - 53" (1016mm - 1346mm)
- Adapter Diameter: 1.375" (35mm)
- Load Capacity: 150 lbs. (68.2 kg)
- Folded: 57.5" x 6" (1461mm x 152mm)

Oversized, heavy wall aluminum tubing for strength and portability.

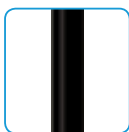

Patented lift-assist TeleLock® collar.



Quick Release design enables a much faster setup and tear down.



Extra tall version extends to 9' 2"!!



Extra tall version extends to 9' 2"!!



Leveling leg for placement on uneven surfaces, risers, or stairs.





PROFESSIONAL SPEAKER STANDS ORIGINAL SERIES



TS-80 tripod speaker stands from Ultimate Support are the industry standard stands you've seen on stages for decades. They're sturdy and lightweight, 100% field serviceable, and are used in more venues, on more stages, and in more shows than any other speaker stand in history. Ultimate Support invented the tripod speaker stand over 30 years ago and the TS-80B, TS-80S, and TS-88B continue the legacy of quality, innovation, and strength today.

TS-80B, item #13904

Original Series Aluminum Tripod Speaker Stand with Integrated Speaker Adapter - Black

Specs:

- Color: Black
- Height: 3'8" - 6'7" (1118mm - 2007mm)
- Weight: 7.3 lbs. (3.3 kg)
- Base Diameter: 47" (1194mm)
- Telescoping Tube Diameter: 1.5" (38mm)
- Adapter Diameter: 1.375" (35mm)
- Load Capacity: 150 lbs. (68.2 kg)
- Folded: 43.5" x 5.5" (1105mm x 140mm)

TS-80S, item #13903

Original Series Aluminum Tripod Speaker Stand with Integrated Speaker Adapter - Silver

Specs:

- Color: Silver
- Height: 3'8" - 6'7" (1118mm - 2007mm)
- Weight: 7.3 lbs. (3.3 kg)
- Base Diameter: 47" (1194mm)
- Telescoping Tube Diameter: 1.5" (38mm)
- Adapter Diameter: 1.375" (35mm)
- Load Capacity: 150 lbs. (68.2 kg)
- Folded: 43.5" x 5.5" (1105mm x 140mm)

TS-88B, item #13906

Original Series Aluminum Tripod Speaker Stand with Integrated Speaker Adapter - Extra Tall Height, Black

Specs:

- Color: Black
- Height: 5'2" - 9'2" (1575mm - 2794mm)
- Weight: 9.8 lbs. (4.5 kg)
- Base Diameter: 62" (1575mm)
- Telescoping Tube Diameter: 1.5" (38mm)
- Adapter Diameter: 1.375" (35mm)
- Load Capacity: 150 lbs. (68.2 kg)
- Folded: 57.5" x 5.5" (1461mm x 140mm)

CLASSIC SERIES

TS-70B, item #13712

Aluminum Tripod Speaker Stand with Safe and Secure Locking Pin - Black

Specs:

- Height: 4'2" - 6'5" (1270mm - 1956mm)
- Weight: 5 lbs. (2.4 kg)
- Base Diameter: 40" (1016mm)
- Telescoping Tube Diameter: 1.375" (35mm)
- Adapter Diameter: 1.5" (38mm)
- Load Capacity: 150 lbs. (68.2 kg)
- Folded: 41.5" x 5" (1054mm x 127mm)

Oversized, heavy wall aluminum tubing for strength and portability.



Patented die-cast metal collar on tripod leg fitting.



Patented tripod design and glass-reinforced fittings and collars for gig-worthy strength.



TS-80B

TS-80S

TS-88B

Extra tall version extends to 9' 2"!

Light weight, super strong aluminum tubing.



Safe, secure fittings and pin mechanism.



Glass-reinforced polycarbonate fittings and collar.





PROFESSIONAL SPEAKER POLES & SPEAKER STAND ACCESSORIES

SPEAKER POLES

SP-100, item #17654

Air-Powered Series Lift-assist Aluminum Speaker Pole with Universal Fit Adapter

Specs:

- Height Range: 37.9" - 59.8" (964mm - 1520mm)
- Upper Tube Size: 1.5" (38.10mm)
- Lower Tube Size: 1.75" (44.45mm)
- Weight Rating: 150 lbs. (68.2kg)
- Weight: 5.7lbs. (2.58kg)

Speaker adapter fits both 1.5" & 1.375" speaker mounts.



Air-Powered Lift speakers weighing 35-45 lbs. with ease!



Universal fit adapter & threaded connector

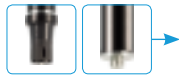

NOW SHIPPING

SP-90, item #17653

TeleLock® Series Lift-Assist Aluminum Speaker Pole with Universal Fit Adapter

Specs:

- Height Range: 36.5" - 57.2" (928mm - 1454mm)
- Upper Tube Size: 1.5" (38.10mm)
- Lower Tube Size: 1.75" (44.45mm)
- Weight Rating: 150lbs. (68.2kg)
- Weight: 3.85lbs (1.75kg)

Patented TeleLock collar holds pole in place while you set speaker height!



NOW SHIPPING

SP-80, item #17652

Original Series Aluminum Speaker Pole with Universal Fit Adapter

Specs:

- Height Range: 36.5" - 60" (928mm - 1520mm)
- Upper Tube Size: 1.5" (38.10mm)
- Lower Tube Size: 1.75" (44.45mm)
- Weight Rating: 150 lbs. (68.2kg)
- Weight: 3.15lbs. (1.42kg)

Patented die-cast metal collar on TLF.



NOW SHIPPING

SPEAKER STAND ACCESSORIES

Bag-90, item #15691

Speaker Stand Tote for One Regular Sized Speaker Stand



Bag-99, item #15692

Speaker Stand Tote for One Extra Tall Speaker Stand



SP/LT, item # 17655

Speaker Pole & Lighting Bar Bag



NOW SHIPPING

Bag-90D, item #15693

Speaker Stand Tote for Two Regular Sized Speaker Stands



Bag-99D, item #15694

Speaker Stand Tote for Two Extra Tall Speaker Stand



TSM-138MK, item #13425

Internal Mounting Bracket for Mounting Speaker Cabinets on Speaker Stands - 1-3/8"



TSM-150MK, item #13421

Internal Mounting Bracket for Mounting Speaker Cabinets on Speaker Stands - 1-1/2"



BMB-200K, item #10766

External Speaker Cabinet Mounting Bracket for Mounting Speaker Cabinets on Speaker Stands



OVER
40
YEARS
OF INNOVATION

PROFESSIONAL LIGHTING TREES

[CLICK ON PRODUCT LINKS](#)

LIGHTING TREES P. 22

LT-99BL

LT-99B

LT-88B

ACCESSORIES P. 24

LTB-48B

LTB-24B

LTV-24B

LT-48FP Fly Point Lighting Bar

Speaker Stand Covers



PROFESSIONAL LIGHTING TREES

TELELOCK®

LT-99B, item #17347

LT Series Multi-tiered, Heavy-duty, Extra Tall Lighting Tree & TeleLock® Lift-assist Technology

Specs:

- Included Components:
 - TS-99B Aluminum Tripod Stand
 - LTV-24B 24" Vertical Extension
 - LTB-48B 48" T-style Lighting Crossbar
 - LTB-24B 24" Lighting Sidebars (Qty: 2)
- Base Diameter: 62" (1575mm)
- Height: 7' 2" to 11' 2" (2184mm to 3406mm)
- Weight: 19.6 lbs. (8 kg)
- Telescoping Tube Diameter: 1.5" (38mm)
- Load Capacity: 150 lbs. (68.2 kg)



LT-99BL, item #17387

LT Series Multi-tiered, Heavy-duty, Extra Tall Lighting Tree & Leveling Leg with TeleLock® Lift-assist Technology

Specs:

- Included Components:
 - TS-99BL Tripod Stand w/Leveling Leg
 - LTV-24B 24" Vertical Extension
 - LTB-48B 48" T-style Lighting Crossbar
 - LTB-24B 24" Lighting Sidebars (Qty: 2)
 - Bag-99D Carrying Bag
- Base Diameter: 62" (1575mm)
- Height: 7' 2" to 11' 2" (2184mm to 3406mm)
- Weight: 19.6 lbs. (8 kg)
- Telescoping Tube Diameter: 1.5" (38mm)
- Load Capacity: 150 lbs. (68.2 kg)

Leveling leg for placement on uneven surfaces, risers, or stairs.



BAG INCLUDED!

ORIGINAL

LT-88B, item #17343

LT Series Multi-tiered, Heavy-duty, Extra Tall Lighting Tree with Patented Aluminum Tripod Stand

Specs:

- Included Components:
 - TS-88B Aluminum Tripod Stand
 - LTV-24B 24" Vertical Extension
 - LTB-48B 48" T-style Lighting Crossbar
 - LTB-24B 24" Lighting Sidebars (Qty: 2)
- Base Diameter: 62" (1575mm)
- Height: 7' 2" to 11' 2" (2184mm to 3406mm)
- Weight: 17.6 lbs (8 kg)
- Telescoping Tube Diameter: 1.5" (38mm)
- Load Capacity: 150 lbs. (68.2 kg)



LIGHTING TREE ACCESSORIES

NOW SHIPPING

LT-48FP Fly Point Lighting Bar item #14109

Speaker Lighting Bar Attachment for Two Lighting Cans



LTV-24B, item #14108

24" Vertical Extension for Adding Additional Height to TS Tripod Speaker Stands



LTB-48B, item #14107

T-style 48" Lighting Crossbar For Use on Ultimate Support TS Tripod Speaker Stands or LTV-24B Vertical Extension



LTB-24B, item #14106

Two 24" Lighting Sidebars For Use on Ultimate Support TS Tripod Speaker Stands or LTV-24B Vertical Extension



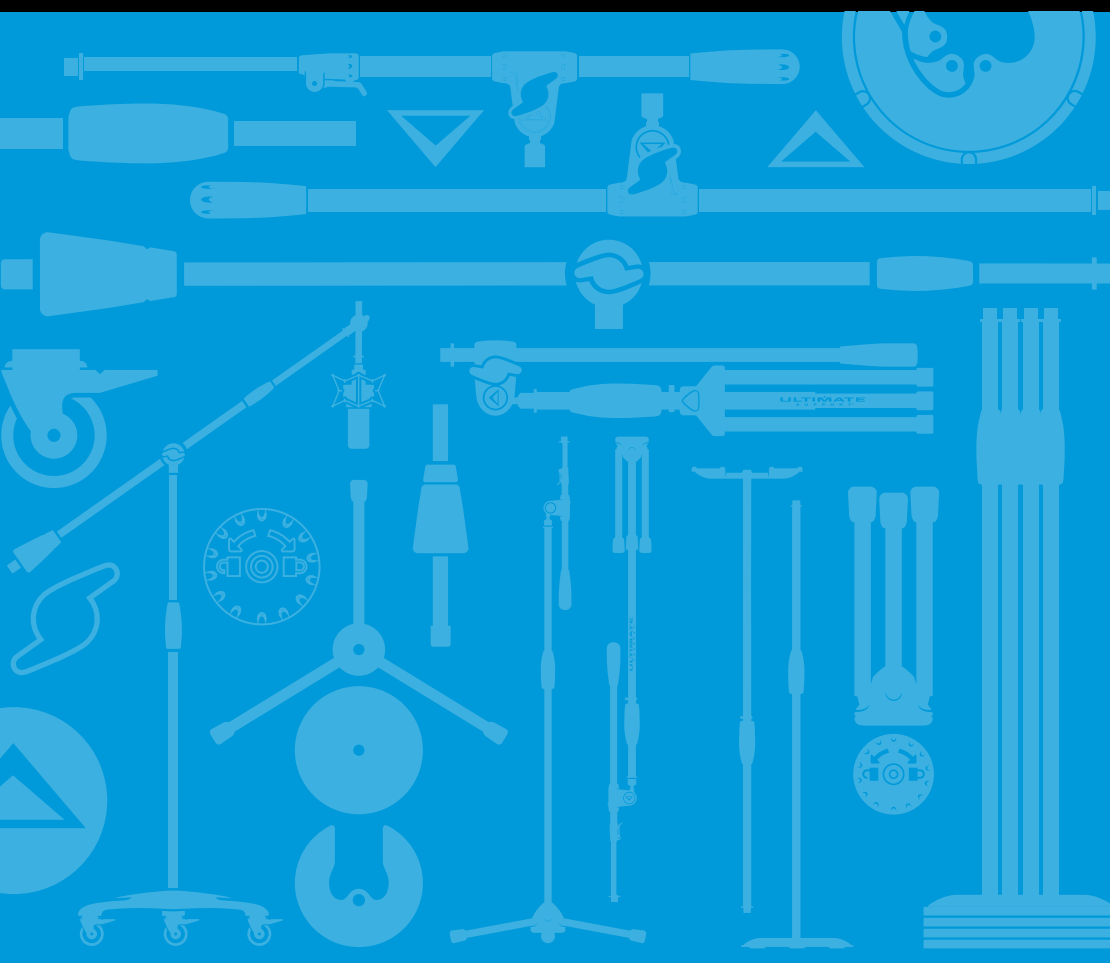

**OVER
40
YEARS
OF INNOVATION**

MICROPHONE STANDS AND BOOMS

[CLICK ON PRODUCT LINKS](#)

PRO SERIES R P. 24

Pro-R-T
Pro-R-T-T
Pro-R-T-F
Pro-R-T-Short-T
Pro-R-T-Short-F
Pro-R-SB
Pro-R-ST

PRO SERIES EXTREME P. 25

Pro-X-T
Pro-X-T-T
Pro-X-T-F
Pro-X-T-Short-T
Pro-X-T-Short-F

FULL TILT P. 26

MC-FT-100
MC-FT-200

LIVE RETRO SERIES P. 26

LIVE-MC-66B
LIVE-MC-70B
LIVE-MC-77B

CLASSIC SERIES P. 27

MC-40B Pro
MC-40B Pro 3-Pack
MC-40B Pro Short
MC-05B

STUDIO SERIES P. 27

MC-125

MIC BOOM SERIES P. 28

Ulti-Boom Pro-F
Ulti-Boom Pro-T
MC-40B Pro Boom

QUICKRELEASE P. 28

QR-5
QR-1



PROFESSIONAL MICROPHONE STANDS

PRO SERIES R

Pro-R-T, item #17955

Pro Series R Microphone Stand with Patented Quarter-turn Clutch - Reinforced Plastic Tripod Base/Standard Height

Specs:

- Tube Material: Steel
- Tube Finish: Powder Coated
- Tube Diameter: .87" (22 mm)
- Base Type: Locking Tripod
- Base Diameter: 26" (660 mm)
- Height Type: Standard
- Shaft Height: 37.5" - 65" (953 mm x 1651 mm)
- Weight: 5.6 lbs (2.5 kg)

Patented Quarter-turn Clutch



Durable Light Weight Tubing



Locking Base is made of durable, lightweight, reinforced plastic.



Pro-R-T-T, item #17957

Pro Series R Microphone Stand with Patented Quarter-turn Clutch - Reinforced Plastic Tripod Base/Standard Height/Telescoping Boom

Specs:

- Tube Material: Steel
- Tube Finish: Powder Coated
- Tube Diameter: .87" (22 mm)
- Base Type: Locking Tripod
- Base Diameter: 26" (660 mm)
- Height Type: Standard
- Shaft Height: 37.5" - 65" (953 mm x 1651 mm)
- Boom Type: Telescoping
- Boom Length: 20" - 35" (508 mm - 889 mm)
- Weight: 7.55 lbs (3.4 kg)

Telescoping Ulti-Boom Pro included.



Pro-R-T-F, item #17956

Pro Series R Microphone Stand with Patented Quarter-turn Clutch - Reinforced Plastic Tripod Base/Standard Height/Fixed Boom

Specs:

- Tube Material: Steel
- Tube Finish: Powder Coated
- Tube Diameter: .87" (22 mm)
- Base Type: Locking Tripod
- Base Diameter: 26" (660 mm)
- Height Type: Standard
- Shaft Height: 37.5" - 65" (953 mm x 1651 mm)
- Boom Type: Fixed
- Boom Length: 31.75" (806 mm)
- Weight: 7.55 lbs (3.4 kg)

Fixed-length Ulti-Boom Pro included.



Pro-R-T-Short-T, item #17959

Pro-R-T-Short-F, item #17958

Pro Series R Microphone Stand with Patented Quarter-turn Clutch - Tripod Base/Short Height/Ulti-Boom Pro

Specs:

- Tube Material: Steel
- Tube Finish: Powder Coated
- Tube Diameter: .87" (22 mm)
- Base Type: Locking Tripod
- Base Diameter: 26" (660 mm)
- Height Type: Short
- Shaft Height: 19.25" - 28.25" (489 mm x 718 mm)
- Boom Length (Telescoping): 20" - 35" (508 mm - 889 mm)
- Boom Length (Fixed-length): 31.75" (806 mm)
- Weight: 6.55 lbs (2.9 kg)

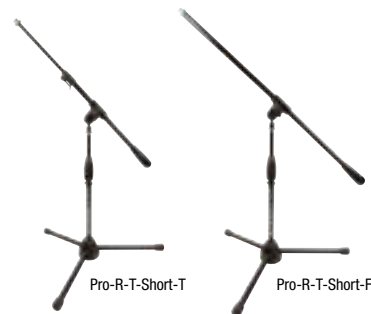

Pro-R-SB, item #17953

Pro Series R Microphone Stand with Patented Quarter-turn Clutch - Stackable Base/Standard Height

Specs:

- Tube Material: Steel
- Tube Finish: Powder Coated
- Tube Diameter: .87" (22 mm)
- Base Type: Weighted Round Stackable Base
- Base Diameter: 11.25" (286 mm)
- Height Type: Standard
- Shaft Height: 35" - 62.5" (889 mm x 1588 mm)
- Weight: 8.15 lbs (3.7 kg)

Stackable base allows up to six stands to stack in the foot print of one.



Pro-R-ST, item #17954

Pro Series R Microphone Stand with Patented Quarter-turn Clutch - Standard Weighted Base/Standard Height

Specs:

- Tube Material: Steel
- Tube Finish: Powder Coated
- Tube Diameter: .87" (22 mm)
- Base Type: Weighted Round Standard Base
- Base Diameter: 11.25" (286 mm)
- Height Type: Standard
- Shaft Height: 35" - 62.5" (889 mm x 1588 mm)
- Weight: 9.15 lbs (4.2 kg)

Round die-cast weighted base



PROFESSIONAL MICROPHONE STANDS
PRO SERIES EXTREME



Pro-X-T, item #17882

Pro Series Extreme Microphone Stand with Patented Quarter-turn Clutch - Die Cast Aluminum Tripod Base/Standard Height

Specs:

- Tube Material: Steel
- Tube Finish: Powder Coated
- Tube Diameter: 1" (25 mm)
- Base Type: Locking Tripod
- Base Diameter: 26" (660 mm)
- Height Type: Standard
- Shaft Height: 39.25" – 68.125" (997mm – 1730.4mm)
- Weight: 6.70 lbs (3.04 kg)

Patented Quarter-turn Clutch



Durable Light Weight Tubing



Locking Base is made of durable, lightweight, reinforced plastic.



SHIPPING
END OF
Q1

Pro-X-T-T, item #17884

Pro Series Extreme Microphone Stand with Patented Quarter-turn Clutch - Die Cast Aluminum Tripod Base/Standard Height/Telescoping Boom

Specs:

- Tube Material: Steel
- Tube Finish: Powder Coated
- Tube Diameter: 1" (25 mm)
- Base Type: Locking Tripod
- Base Diameter: 26" (660 mm)
- Height Type: Standard
- Shaft Height: 39.25" – 68.125" (997mm – 1730.4mm)
- Boom Type: Telescoping
- Boom Length: 20" - 35" (508 mm - 889 mm)
- Weight: 8.6 lbs (3.90 kg)

Telescoping Ulti-Boom Pro included.



SHIPPING
END OF
Q1

Pro-X-T-F, item #17883

Pro Series Extreme Microphone Stand with Patented Quarter-turn Clutch - Die Cast Aluminum Tripod Base/Standard Height/Fixed Boom

Specs:

- Tube Material: Steel
- Tube Finish: Powder Coated
- Tube Diameter: 1" (25 mm)
- Base Type: Locking Tripod
- Base Diameter: 26" (660 mm)
- Height Type: Standard
- Shaft Height: 39.25" – 68.125" (997mm – 1730.4mm)
- Boom Type: Fixed
- Boom Length: 31.75" (806 mm)
- Weight: 8.6 lbs (3.90 kg)

Fixed-length Ulti-Boom Pro included.

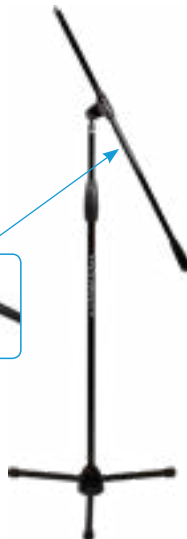

SHIPPING
END OF
Q1

Pro-X-T-Short-T, item #17886

Pro Series R Microphone Stand with Patented Quarter-turn Clutch - Tripod Base/Short Height/Ulti-Boom Pro

Specs:

- Tube Material: Steel
- Tube Finish: Powder Coated
- Tube Diameter: 1" (25 mm)
- Base Type: Locking Tripod
- Base Diameter: 26" (660 mm)
- Height Type: Short
- Shaft Height: 20.875" – 29.625" (530mm – 752.5mm)
- Boom Length (Telescoping): 20" - 35" (508 mm - 889 mm)
- Boom Length (Fixed-length): 31.75" (806 mm)
- Weight: 7.25 lbs (3.29 kg)



SHIPPING
END OF
Q1

MIC STAND COMPARISON

WHAT MIC STAND FITS YOU?

Live Retro Series	Pro Extreme Series	Pro-R Series	Classic Series
46.875" - 73.75"	39.25" - 68.125"	37.5" - 65"	36" - 63"
Height Adjustable Grip	Oversize Grip	Standard Grip	Standard Grip
Oversized Tubing Aluminum Size: 1"	Oversized Tubing Steel Size: 1"	Standard Tubing Steel Size: .87"	Standard Tubing Steel Size: .87"
Reinforced Plastic Locking Legs	Solid Metal Locking Legs	Reinforced Plastic Locking Legs	Reinforced Plastic Folding Legs



PROFESSIONAL MICROPHONE STANDS

FULL-TILT

MC-FT-200, item #17943

Full-Tilt (Adjustable) Microphone Stand with Foot Pedal Control (0° - 10° Tilt)

Specs:

- Base Type: Full-Tilt (Adjustable)
- Height Type: Standard
- Vertical Height: 35" - 62.75" (889mm x 1594mm)
- Angled Height: 34.75" - 61.75" (883mm x 1568mm)
- Tube Diameter: .87" (22 mm)
- Tube Material: Steel
- Base Diameter: 11.25" (286mm)
- Weight: 10.5 lbs. (4.8 kg)

Durable, lightweight aluminum construction.



Locking tripod base.



MC-FT-100, item #17913

Full-Tilt (Fixed) Microphone Stand (0° & 10° Tilt)

Specs:

- Base Type: Full-Tilt (Fixed)
- Height Type: Standard
- Vertical Height: 35" - 62.75" (889mm x 1594mm)
- Angled Height: 34.75" - 61.75" (883mm x 1568mm)
- Tube Diameter: .87" (22 mm)
- Tube Material: Steel
- Base Diameter: 11.25" (286mm)
- Weight: 11.05 lbs. (5 kg)

Durable, lightweight aluminum construction.



Locking tripod base.



LIVE RETRO SERIES (ONE-HANDED CLUTCH)

LIVE-MC-66B, item #17962

Live Retro Series Microphone Stand with One-handed Height Adjustment, Durable Lightweight Aluminum Construction – Tripod Locking Legs

Specs:

- Tube Material: Aluminum
- Tube Diameter: 1" (25mm)
- Base Type: Locking Tripod
- Base Diameter: 26" (660mm)
- Height Type: Standard
- Shaft Height: 46.875" - 73.75" (1191mm - 1873mm)
- Weight: 4.3 lbs. (1.9 kg)

Ergonomic clutch - one-handed height adjustment.



Durable, lightweight aluminum construction.



Locking tripod base.



NOW SHIPPING

Live-MC-77B, item #17960

Live Retro Series Microphone Stand with One-handed Height Adjustment, Durable Lightweight Aluminum Construction – Stackable Round Weighted Base

Specs:

- Tube Material: Aluminum
- Tube Diameter: 1" (25mm)
- Base Type: Weighted Round Stackable Base
- Base Diameter: 26" (660mm)
- Height Type: Standard
- Shaft Height: 43.875" - 70.75" (1114mm - 1797mm)
- Weight: 7.95 lbs. (3.6 kg)

Stackable base allows up to six stands to stack in the foot print of one.



NOW SHIPPING

Live-MC-70B, item #17961

Live Retro Series Microphone Stand with One-handed Height Adjustment, Durable Lightweight Aluminum Construction – Standard Round Weighted Base

Specs:

- Tube Material: Aluminum
- Tube Diameter: 1" (25mm)
- Base Type: Weighted Round Standard Base
- Base Diameter: 26" (660mm)
- Height Type: Standard
- Shaft Height: 43.875" - 70.75" (1114mm - 1797mm)
- Weight: 9.10 lbs. (4.1 kg)

Stable weighted base.



NOW SHIPPING



PROFESSIONAL MICROPHONE STANDS CLASSIC SERIES

MC-40B Pro, item #17950

Classic Series Tripod Microphone Stand with Three-way Adjustable Boom Arm and Stable Tripod Base

Specs:

- Boom length: 31.75" (806mm)
- Height: 36" - 63" (914mm - 1600mm)
- Tube Diameter: .875" (22mm)
- Tube Material: Steel

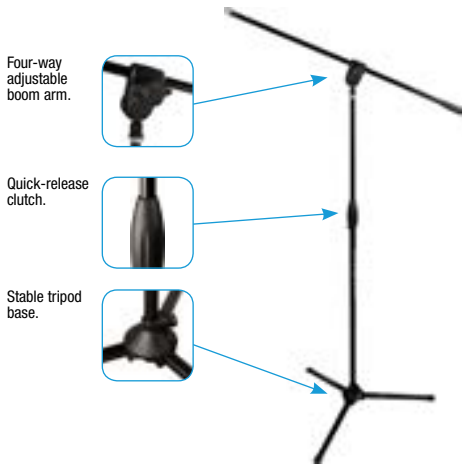

MC-40B Pro 3-Pack, item #17951

Classic Series Tripod Microphone Stand with Three-way Adjustable Boom Arm and Stable Tripod Base — 3-Pack

Specs:

- Boom length: 31.75" (806mm)
- Height: 36" - 63" (914mm - 1600mm)
- Tube Diameter: .875" (22mm)
- Tube Material: Steel



MC-40B Pro Short, item #17905

Classic Series Short Tripod Microphone Stand with Three-way Adjustable Boom Arm and Stable Tripod Base

Specs:

- Boom length: 24" (610mm)
- Height: 18.25" - 27.75" (464mm - 705mm)
- Tube Diameter: .875" (22mm)
- Tube Material: Steel

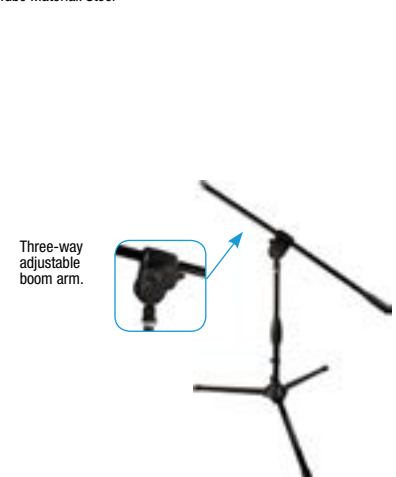

CLASSIC SERIES (CONT'D)

MC-05B, item #13461

Classic Series Microphone Stand with Quick-release Clutch and Weighted Round Base

Specs:

- Finish: E-coated
- Base Type: Round Weighted Base
- Base Diameter: 10" (254mm)
- Height Type: Standard
- Height: 34.75" - 64" (883mm - 1626mm)
- Tube Diameter: .87" (22mm)
- Weight: 8.8 lbs. (4 kg)

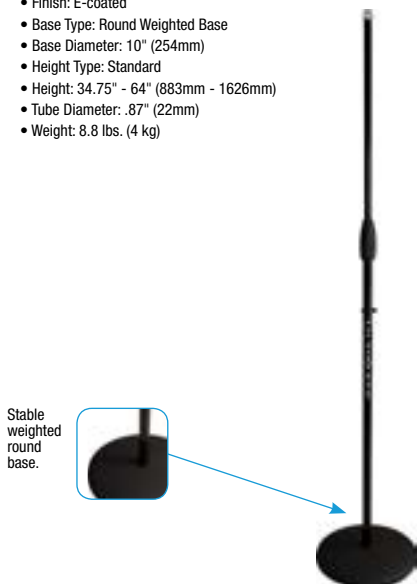

STUDIO SERIES

MC-125, item #16124

Studio Boom with Adjustable Counter Weight and Rollerblade Style Caster Wheels

Specs:

- Finish: Powder Coated
- Base Type: Weighted Base with Wheels
- Base Diameter (with Casters): 26" (660mm)
- Height: 51.5" - 82.75" (1308mm - 2102mm)
- Tube Diameter: 1.1" (28mm)
- Weight: 35 lbs. (15.88 kg)
- Boom Length: 35" - 61" (889mm - 1549mm)
- Counterweight Weight: 5.75 lbs. (2.6 kg)



PROFESSIONAL MICROPHONE STANDS ULTI-BOOM PRO SERIES

Ulti-Boom Pro-TB, item #17651

Microphone Boom Arm with Patented One-touch Adjustment, StableLock Telescoping Lever, & Metal Counterweight - Telescoping

Specs:

- Boom Length: 20"-35" (508mm - 889mm)
- Counterweight: .65 lbs. (0.3 kg)

Ulti-Boom Pro-FB, item #17650

Microphone Boom Arm with Patented One-touch Adjustment & Metal Counterweight - Fixed Length

Specs:

- Boom Length: 34.75" (883mm)
- Counterweight: .65 lbs. (0.3 kg)

MC-40B BOOM SERIES

MC-40B Pro Boom, item #17952

Fixed Microphone Boom With Four Degrees of Freedom

Specs:

- Boom Length: 31.75" (806mm)

Adjusts telescoping arm quickly, and doesn't allow it to slip!



Oversized and heavy-duty tubing.



Heavy-duty counterweight.



Patented One-Touch Adjustment



Tilt



Pan



Depth



Rotate

Ulti-Boom Pro TB

Ulti-Boom Pro FB

MC-40B Pro Boom

QUICKRELEASE



CASE INCLUDED!

QR-5, item #17516

Five (5) QuickRelease Adapters for Microphone Stands and Microphone Clips & Free Carrying Case Bundle

- Five QR-1 adapters included
- Handy carrying case for FREE!
- Quickly swap mics on stands
- 2-piece QuickRelease adapter
- Made from strong steel

MAP

\$19.99



QR-1, item #17512

QuickRelease Adapter for Microphone Stands and Microphone Clips

- 2-piece QuickRelease Adapters
- Made from strong steel



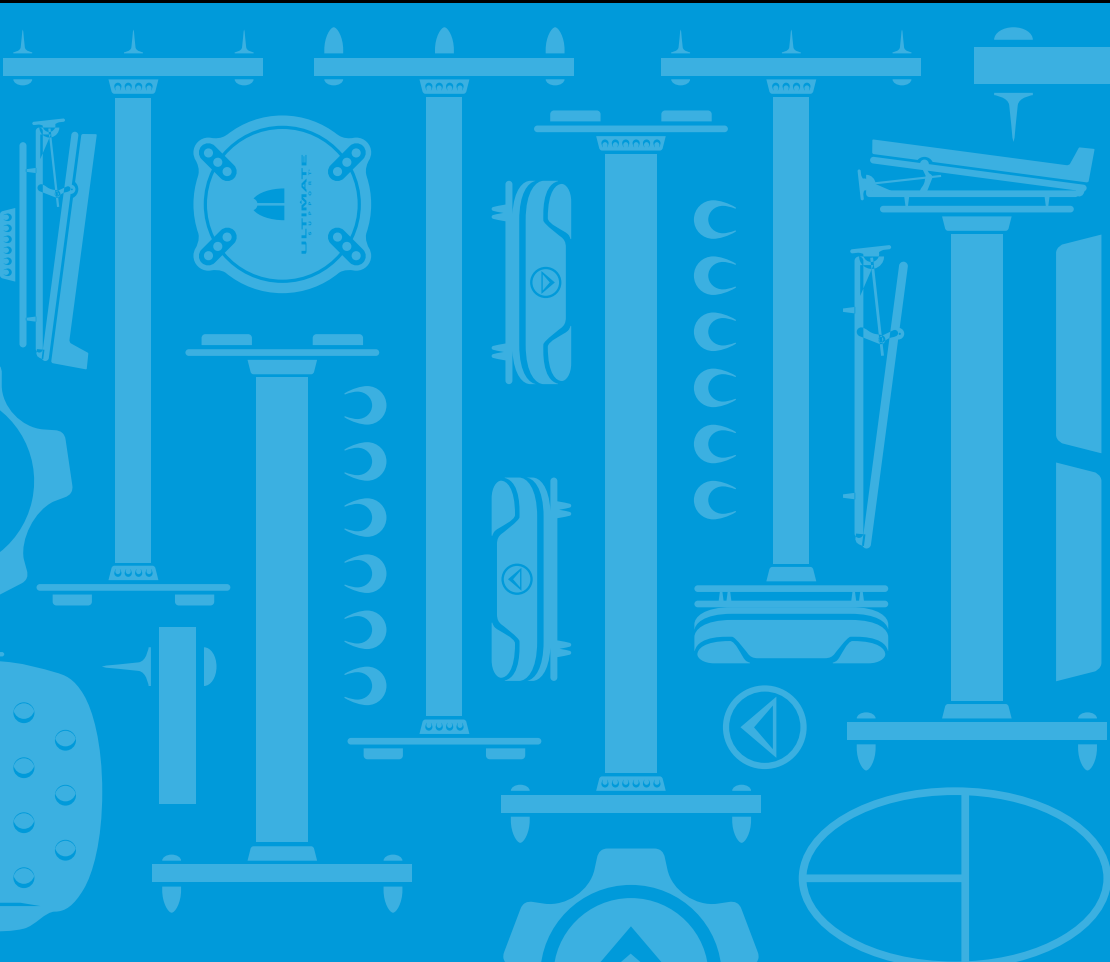

**OVER
40
YEARS
OF INNOVATION**

PROFESSIONAL MONITOR STANDS

[CLICK ON PRODUCT LINKS](#)

COLUMN, ANGLE-ADJUSTABLE P. 30

MS-100B (Black)

MS-100R (Red)

COLUMN, 36" TALL P. 30

MS-36B (Black)

MS-36R (Red)

COLUMN, 45" TALL P. 30

MS-45B (Black)

MS-45R (Red)

DESKTOP, ANGLE-ADJUSTABLE P. 30

MS-80B (Black)



PROFESSIONAL MONITOR STANDS

MONITOR STANDS

MS-100 (New Design)

Second Generation Column Studio Monitor Stand with Adjustable Angle/Axis and Acoustic Foam Pads - Black or Red Accents

Specs:

- Sold in Pairs
- Load Capacity: 75 lbs. (34,1 kg)
- Height: 38" (965 mm)
- Top Plate: 12" x 10.25" (305 mm x 260 mm)
- Base Diameter: 19" (482 mm)
- Weight: 12.4 lbs. (5,6 kg)



MS-90 (New Design)

Second Generation Column Studio Monitor Stand with Non-marring Decoupling Pads - Black or Red Accents, 36" or 45" Height

Specs:

- Sold in Pairs
- Load Capacity: 75 lbs. (34,1 kg)
- MS-90/36 Height: 36" (914mm)
- MS-90/45 Height: 45" (1143mm)
- Top Plate: 10.25" x 10.25" (260 mm x 260 mm)
- Base Diameter: 19" (482mm)
- MS-90/36 Weight (before filling column): 9.6 lbs. (4,4 kg)
- MS-90/45 Weight (before filling column): 10.7 lbs. (4,8 kg)



Non-marring decoupling pads.



Internal channels for cable and dampening management.



Sonic isolation and decoupling throughout.



Rubber foot caps and spikes included.



MS-80, item #17379 (New Design)

Angle-adjustable Desktop Studio Monitor Stands with Acoustic Foam Pads and Rubber Spiked Feet

Specs:

- Sold in Pairs
- Load Capacity: 75 lbs. (34,1 kg)
- Top Plate: 12" x 10.25" (305 mm x 260 mm)
- Weight: 3.1 lbs. (1,4 kg)

NEW FEATURE

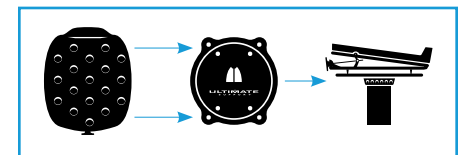

OPTIONAL CONFIGURATION (SOLD SEPARATELY)
Combine the MS-80B to the New MS-90, then adjust angle and axis on a column monitor stand.

Foam padding and rubber feet for sonic isolation.



Adjust the angle of your desktop speakers – up or down!





PROFESSIONAL LAPTOP MOUNTS & STANDS

[CLICK ON PRODUCT LINKS](#)

COMPACT LAPTOP STAND P. 32

HYP-1010

LAPTOP MOUNT & STAND ACCESSORIES P. 33

QR-5

QR-1

LAPTOP MOUNT & STANDS P. 32-33

LPT-1000QR

HYM-100QR



PROFESSIONAL LAPTOP MOUNTS AND STANDS

COMPACT LAPTOP STAND

HYP-1010, 17981

Hyper® Series Ergonomic Compact Laptop Stand

Specs:

- Max Usable Height: 13" (330mm)
- Minimum Usable Height: 4" (102mm)
- Support Arm Width: 9.875" (251mm)
- Support Arm Depth: 8" (203)
- Folded Width: 11.75" (298mm)
- Folded Height: 1.25" (32mm)
- Folded Length: 13.25" (337)
- Weight: 4.95 lbs. (2.2 kg)



BAG INCLUDED!

LAPTOP MOUNT AND STANDS

HyperStation QR, 17510

Desktop and 5/8" Thread Mountable Laptop/DJ Stand with Angle-adjustable Telescoping Support Arms, Height-adjustable Second Tier, and QuickRelease™ Center Post

Specs:

- Height: 12.5" (318mm)
- Base Width: 10.25" (260mm)
- Base Depth: 10.5" (267mm)
- Arms Width: 10.25" (260mm)
- Arms Depth (inside): 8.0" – 13" (203mm – 330mm)
- Second Tier Width: 6.25" (159mm)
- Second Tier Depth: 8.5" (216mm)
- Folded Dimensions: 2.5" x 10.5" x 13" (64mm x 267mm x 330mm)
- Weight: 6.85 lbs. (3.1 kg)



QuickRelease adapter for microphone stands



PROFESSIONAL LAPTOP MOUNTS & STANDS

LAPTOP MOUNT AND STANDS (CONT'D)

HyperMount QR, 17511

Desktop and 5/8" Thread
Mountable Laptop/DJ Stand with
Angle-adjustable Telescoping Support
Arms, Height-adjustable Second Tier, and
QuickRelease™ Center Post

Specs:

- Height: 5.75" (146mm)
- Height w/T-Stand: 6.75" (171mm)
- Arms Width: 10.25" (260mm)
- Arms Depth (inside): 8.0" – 13"
(203mm – 330mm)
- Folded Dimensions: 1.5" x 10.5" x 13" (38mm x
267mm x 330mm)
- Weight: 3.35 lbs. (1.5 kg)



LAPTOP MOUNT AND STAND ACCESSORIES

QR-5, item #17516

Five (5) QuickRelease
Adapters for Microphone Stands and
Microphone Clips & Free Carrying
Case Bundle

- Five QR-1 adapters included
- Handy carrying case for FREE!
- Quickly swap mics on stands
- 2-piece QuickRelease adapter
- Made from strong steel



QR-1, item #17512

QuickRelease Adapter for
Microphone Stands and
Microphone Clips

- 2-piece QuickRelease
Adapters
- Made from strong steel



ULTIMATE SUPPORT®

2019 CATALOG Q1



ULTIMATESUPPORT.COM 800.525.5628