

# SUPER RACK

User Guide



# Contents

Introduction .....	1
<b>Part 1: Getting Started .....</b>	<b>2</b>
Software Installation .....	2
Hardware Configurations .....	4
<i>Connecting the Hardware</i> .....	7
<i>SuperRack SoundGrid I/O Device Assignment</i> .....	8
Routing I/O Channels to Racks .....	10
Inserting Plugins .....	12
Floating Panels .....	13
Detaching a Panel.....	13
Detached Plugin Panes.....	14
Hot Plugins Panel.....	14
Tear-Off Windows .....	15
System Requirements .....	16
Display Resolution.....	16
<b>Part 2: Top Bar .....</b>	<b>17</b>
Left Panel: Rack Controls.....	18
<i>Rack Name</i> .....	18
<i>Racks Menu</i> .....	18
Rack Select.....	19
Racks Menu: Import and Export Presets.....	19
Racks Menu: Save and Copy Presets.....	20
Racks Menu: Copy/Paste Presets .....	20
Racks Menu: Rack Recall And Auto Route .....	21
<i>Current Preset</i> .....	21
<i>Link Group Assignment</i> .....	22
<i>Latency Group Assignment</i> .....	23
Center Section: Window Selection Tabs .....	24
Overview 1 and Overview 2 Windows .....	24



- Rack Window ..... 24
- Show Window ..... 25
- Patch Window ..... 25
- Setup Window ..... 26
- Tearing Off Windows for Multiple Displays* ..... 26
- Right Panel: Snapshots and Utilities** ..... 27
- Snapshot Menu*..... 27
- Status Panel*..... 28
- Indicator ..... 28
- Color ..... 28
- Status..... 28
- CPU and Memory Displays* ..... 29
- Session Menu*..... 30
- Utilities* ..... 31
- Clock ..... 31
- Full Screen Mode..... 31
- On-Screen Keyboard ..... 31
- Global Tempo Section ..... 31
- Lock Button ..... 31
- Get Info Panel (click on WSG SuperRack logo)..... 31
- Floating Panels List..... 31
- Part 3: Setup Window**..... 32
- Assigning Devices: Inventory Page** ..... 33
- Network Control Section (Top)* ..... 34
- Device Racks*..... 36
- Device Rack Elements..... 37
- Assigning I/O Devices ..... 38
- I/O Device Icon Indicators..... 39
- I/O Devices Menu Items..... 42
- Setting Clock Master ..... 43
- Working with Multiple Systems ..... 45
- Assigning Servers*..... 49
- Assigning Controllers*..... 52
- Routing View Panel* ..... 53
- Settings Page**..... 55

<b>Part 4: Patch Window .....</b>	<b>61</b>
Patch Views.....	61
Patching Frameworks.....	62
Patch Grid .....	65
Managing Latency in SuperRack.....	66
<i>Latency Compensation</i> .....	67
<i>Latency Groups</i> .....	68
<i>Latency Group Alignment</i> .....	69
<b>Part 5: Rack Window.....</b>	<b>70</b>
Selecting a Rack.....	71
Rack Input Section.....	71
Rack Output Section.....	73
Routing Racks Automatically .....	75
Inserting a Plugin.....	76
<i>Plugins Chainer</i> .....	77
<i>Plugins Can Change the Rack Size</i> .....	78
<i>Plugin Pane</i> .....	79
Managing Plugins .....	80
<i>The Plugin Menu</i> .....	80
Basic Plugin Menu .....	80
Expanded Plugin Menu .....	81
<i>External Inserts</i> .....	84
<i>Recall-Safe Plugin</i> .....	85
<i>Plugin Position in the Rack</i> .....	85
<i>Touch and Slide Control</i> .....	86
Rack Presets .....	87
<b>Part 6: Overview Windows .....</b>	<b>88</b>
Layers.....	91
<i>Factory Layers</i> .....	91
<i>Custom Layers</i> .....	91
<i>Wide View Layer</i> .....	93





Modes .....	94
Racks .....	95
<i>Selecting Rack Input</i> .....	96
<i>Plugin Chainer</i> .....	100
<i>Inserting a Plugin</i> .....	100
<i>Other Plugin Menu Items</i> .....	101
<i>Managing Plugin Icons in the Overview Window</i> .....	102
<i>Output Section</i> .....	104
Dugan Automixer: .....	105
<b>Part 7: Show Window .....</b>	<b>107</b>
Sessions Page .....	108
<i>Sessions List</i> .....	110
<i>Saving a Session</i> .....	110
<i>Loading a Session</i> .....	111
<i>Resolving Load Errors</i> .....	112
<i>Templates</i> .....	114
<i>Auto-Save Sessions (History)</i> .....	114
Snapshots Page .....	116
<i>Snapshots List</i> .....	118
Storing Snapshots in the Snapshots List .....	118
Recalling Snapshots from the Snapshots List .....	119
Changing the Order of the Snapshots List .....	119
Storing a Snapshot with the Top Bar Snapshot Menu .....	119
<i>Hot Snapshots</i> .....	120
<i>MIDI Control Changes for Snapshots</i> .....	121
<i>Assigning Remote IDs to Snapshots</i> .....	121
Scope Page .....	122
<i>Scope Parameters</i> .....	123
<i>Recall Safe Page</i> .....	124
Recall Safe for Specific Plugins .....	125
Rack Recall Safe .....	125
<b>Supplementary Material .....</b>	<b>126</b>
Controlling SuperRack Remotely .....	126



*Assigning Controls* ..... 127  
MIDI Controller..... 128  
Plugin MIDI Mapping ..... 130  
Console Remote Control ..... 132  
Touch and Turn ..... 133  
*Console Mirroring:*..... 134  
Keyboard Shortcuts and Modifiers ..... 136



# Introduction

SuperRack SoundGrid is a software host that lets live sound engineers run multiple, simultaneous instances of the same award-winning Waves plugins used in recording studios and mixing rooms the world over. It provides a software equivalent of outboard hardware processing racks. SuperRack can be configured with up to 64 racks, and each rack can host up to eight plugins. You can view and control one plugin, or one rack, or up to 64 racks at a time.

SuperRack operates in a SoundGrid network with a dedicated SoundGrid server. This moves plugin processing from the host computer to the server and significantly increases plugin count, minimizes latency, and enables the host and I/O devices to be far removed from each other.

The first chapter of this user guide is about getting started: installation, configuration, and the basics of using SuperRack. Read it; it may be all you need. The rest of this guide provides detailed descriptions and about every section of the product. You'll also find explanations of some of the concepts that you need in order to effectively run a networked system (e.g., clock, I/O sharing, chaining, latency). There's a comprehensive table of contents that will quickly take you to the topic you need, and throughout the guide there are internal links that jump to relevant information.

## USEFUL WAVES CONTACTS

[www.waves.com](http://www.waves.com)

<https://www.waves.com/downloads/central>

<https://www.waves.com/support/tag/>

[troubleshooting https://www.waves.com/contact-us](https://www.waves.com/contact-us)

<https://www.waves.com/hardware>

Download the Waves Central application, used to install Waves software products and activate licenses.

FAQs and troubleshooting

How to reach us

Learn about compatible SoundGrid hardware: servers, I/Os, and switches.



# Part 1: Getting Started

Follow these steps to get up and running:

- Download and install all software and licenses
- Connect hardware
- Assign devices
- Configure racks
- Insert plugins

This chapter is more of a checklist than a detailed recipe—refer to the chapters that follow for more information.

## *Software Installation*

1. Use the Waves Central application to download and install all Waves software and manage licenses. If you don't have Waves Central, you can download it here: <https://www.waves.com/downloads>. You'll need a free Waves User Account to log on to Waves Central. If you don't already have a Waves account, click the Sign Up button on the Waves home page.
2. Launch Waves Central. On the left side of the interface, select Install Products and then go to My Products. This shows a list of all of your Waves purchased products. If you don't see SuperRack or your plugins in this list, go to your Waves account and register the products. You can also select the All Products tab, which shows you a list of the entire Waves catalogue. This is an easy way to choose plugins for purchase or demo.
3. Select the SuperRack application and the plugins that you want to install. Products selected for installation and/or license activation are shown in a list on the right side. Click the "Install" button, or "Install & Activate" if you are activating licenses. The SuperRack application and your plugins will be installed on your computer. By default, licenses are activated to your computer.
4. You can install SuperRack and your plugins on more than one computer (e.g., your studio computer, along with a few live venue setups). Follow the instructions above to install SuperRack and your plugins on as many computers as you like, and then activate your licenses to a USB flash drive rather than to your computer.



When you move from one computer to another, insert the flash drive, scan for plugins, and you're ready to go. You cannot use one license simultaneously on more than one system.

If your production computer is not connected to the internet, you can use Waves Central to create an offline installer. An offline installer must be created on a computer that's connected to the internet. It includes the SuperRack application and your plugins. Save this installer on a USB flash drive and use it to install SuperRack on your production computer (that is not connected to the internet). Activate your licenses separately on a USB flash drive.

Please refer to the [Waves Central User Guide](#) for details

SuperRack runs on Windows and Mac.



## Hardware Configurations

SuperRack SoundGrid is part of a high-speed SoundGrid network. This network consists of at least these four hardware components, all of which are connected with Ethernet cable.

- 1 Host computer** Runs the SuperRack that controls the SoundGrid network. The SuperRack application, plugins, and preset files are located here. However, audio is not processed on the host computer. The SuperRack application runs on both Mac and Windows and can support multiple displays.
- 2 SoundGrid server** The “number cruncher”—all plugin processing is done here. The speed of the server has a direct impact on the number of SoundGrid channels and plugin instances available to you.
- 3 SoundGrid 1Gb Ethernet switch** Links the I/O devices, server, and host computer. Note the model and version of the switch you purchase: some versions work well, others don't. To ensure compatibility, we suggest that you obtain your Ethernet switches from Waves.
- 4 Console/sound card/I/O devices** You can assign SoundGrid I/O devices that are located on the SoundGrid network. These range from 2-channel preamps to 128-channel MADI interfaces. You can also use the ASIO/Core Audio sound card as the I/O or add a console expansion card.

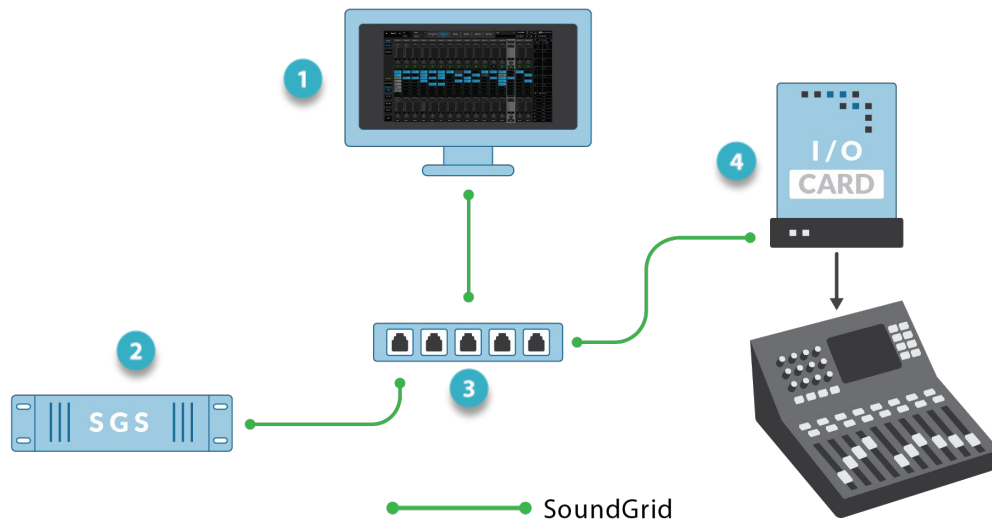

Every SuperRack SoundGrid setup, no matter how large or complex, is based on this configuration.

Larger systems may have more I/Os—hardware and drivers—an extra server, more switches, a second computer for a dedicated DAW, or more controllers.



## SuperRack SG with Console Expansion Card and Second Server

● SoundGrid

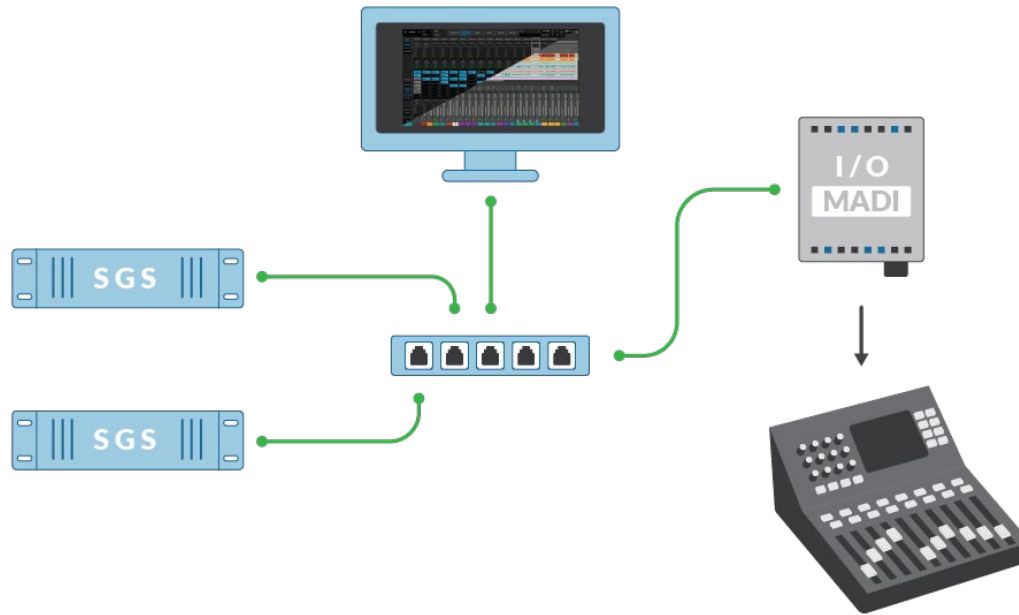

In this setup, a MADI I/O provides up to 128 SoundGrid channels. Here, the MADI I/O is serving the stage preamps, monitor, and FOH.

A second server has been added to provide complete processing redundancy.

The host computer can also run a DAW for recording and for virtual sound check.



## SuperRack SG with I/Os for Stage and FOH

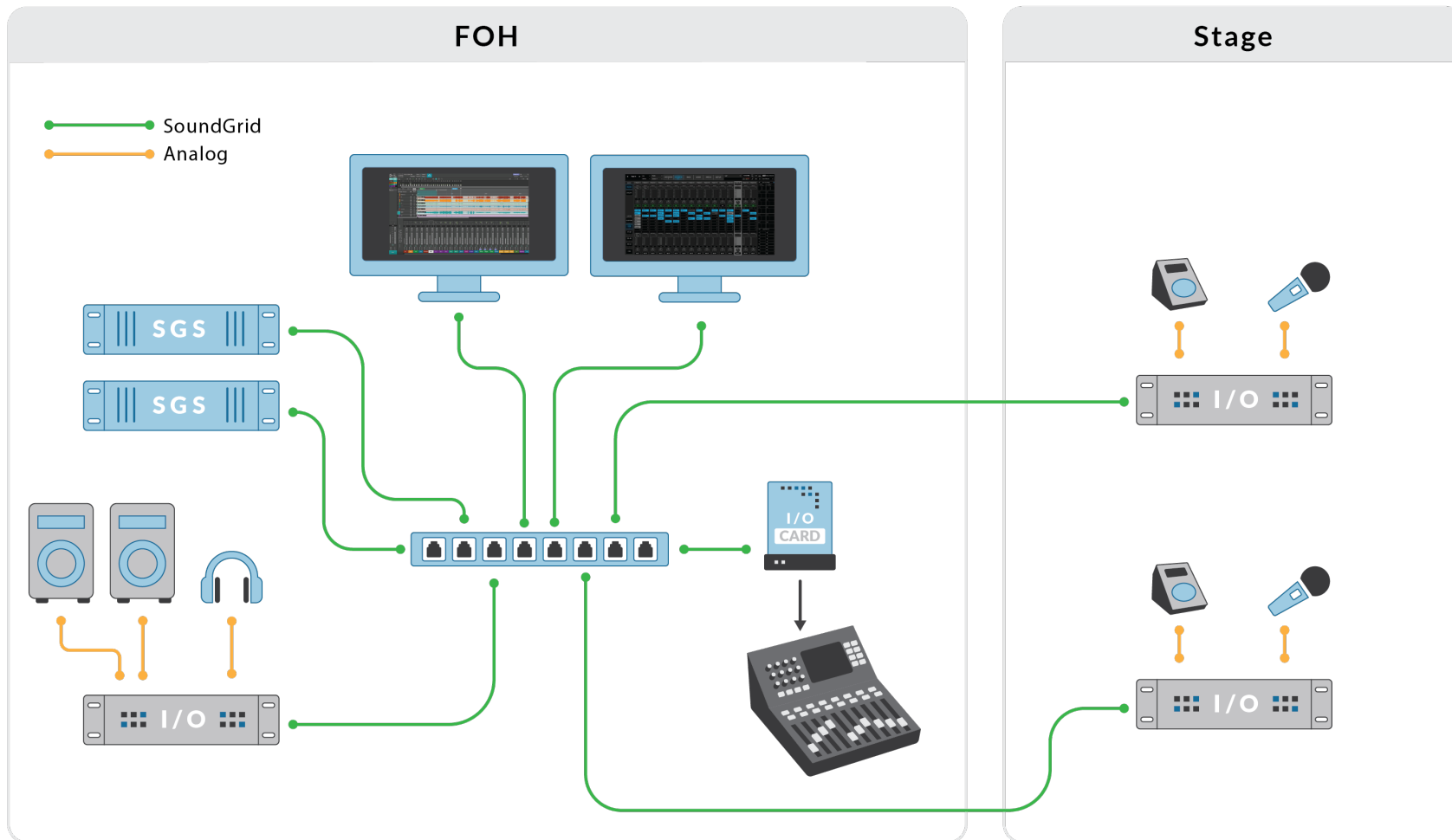

This is a classic SuperRack SoundGrid FOH/Stage configuration. It provides on-stage I/Os for mics and monitors and an I/O for FOH and PA. A second computer is dedicated to a DAW or recorder. This setup is built on the basic SuperRack configuration, even though it's larger and stronger. You can add more I/Os anywhere on the SoundGrid network. You can also assign driver channels from the host computer.





## Connecting the Hardware

1. Connect the console interface card or other sound card and all other I/O devices to the 1Gb Ethernet switch. The sequence of the connectors on the switch is unimportant. Use Cat 5e or better cable. Do not use Cat 5 cable, and, if possible, don't "daisy chain" devices.

Cable specifications are available in the [SuperRack product page](#).

For descriptions and specifications of SoundGrid-compatible I/Os, servers, and Ethernet switches, visit the [Hardware Pages](#) on the Waves website.

2. Take care to protect connectors and cables from crushing and shearing.
3. Connect the host computer and server(s) to the switch.
4. Power up all devices.
5. Launch SuperRack.



## SuperRack SoundGrid I/O Device Assignment

This is an overview of device assignment in SuperRack SoundGrid. To learn more, refer to the [Assign I/O Devices: SuperRack SoundGrid](#) section of this user guide.

Your SoundGrid network assets are referred to as the “Inventory.” These devices are assigned in the Setup Window >Inventory Page.



- 1 Setup Window tab
- 2 Inventory Page tab
- 3 Auto-Configuration button
- 4 Rack slots with assigned I/O devices
- 5 Empty rack slots
- 6 Server slots with Primary and Redundant servers
- 7 Host computer LAN port selector



## Automatic Device Configuration

You can configure your I/O devices and servers automatically. Launch SuperRack SoundGrid and go to the Setup window. Click Auto-Configure. This scans the SoundGrid network and locates the correct LAN port, and then assigns I/O devices and servers to slots in the inventory. It also routes devices to racks sequentially.



When the configuration has finished, there will be a brief audio dropout, the length of which depends on the size of the session. Don't reconfigure when you can't tolerate a drop. Wait for a short pause in the program.

If you later change your inventory, you can reconfigure the devices by clicking the Auto-Configuration button.

## Manual Device Configuration

### I/O Devices

1. Use the PORT drop-down menu to select the host computer's LAN port that's connected to the SoundGrid network. When the correct port is selected, the LINK and SPEED indicators will display valid data.
2. Assign devices to slots in the Inventory. Click the "+" sign in an empty slot in the I/O section to open the Device menu. Assign a device from the Network Devices list. Repeat this for as many devices as you need—you can do this in any slot.
3. By default, the first I/O device assigned will be the clock master device of the SoundGrid network. The clock master icon is blue, all slaves are green.

To assign another device as the master, open the Device menu and select "Set Master." Confirm that all devices show the correct sample rate and sync status. If a device will not sync to the clock master device, try these actions:

- Remove the device and reassign it.
- Power cycle the hardware device and check cables.
- If possible, reassign the clock master to another device.

### Servers

Servers are assigned in the same manner as I/O devices. If you assign two servers, the second is marked as redundant (RSGS).

To learn more about assigning devices, please refer to [Part 3: Setup Window](#).



## Routing I/O Channels to Racks

A rack must be routed to an input and output I/O, whether channels from an ASIO/Core Audio driver, the console's expansion card, or an additional hardware device. Rack input and output routing is done in the Rack or Overview windows.

### Routing Racks Manually

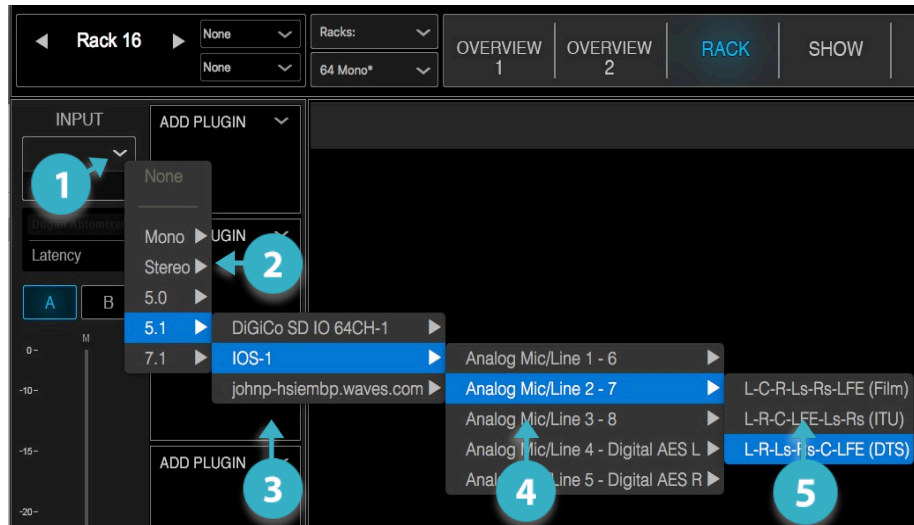

- 1 Select a rack and open its Input drop-down menu using the arrow at the top.
- 2 Choose the format of the input signal (e.g., mono, stereo, 5.1).
- 3 Select a device.
- 4 Select I/O channels.
- 5 Choose a stem format. Some multitrack formats offer different streaming sequences to meet varied delivery requirements.

In this example, Rack 16 input is six channels wide (5.1). Its patching is:

*Input A, IOS-1, Analog mic/line channels 2-7, stream format DTS (L-R-Ls-Rs-C-LFE).*

### Rack outputs are routed in the same manner.

A rack's input and output do not necessarily need to have the same number of tracks. A stereo rack input can, for example, coexist with a 5.1 output. The rack's L/R signal will output only from the L and R channels of the 5.1 I/O stream. The position of the L and R channels in the 5.1 output will vary depending on the 5.1 format. If rack output is unassigned when the input is routed, SuperRack will attempt to patch the same input and output I/O channels.

An I/O can be patched to several rack inputs. Only one rack can patch to an output I/O.



## Routing Asymmetrical Racks



If the channel formats for the rack's input and output are the same (e.g., mono-to-mono, stereo-to-stereo, 5.1-to-5.1, etc.), the I/O channel numbers for a rack's in and out will increment together. Here, inputs and outputs are mono:

Rack 1: input D1, output D1

Rack 2: input D2, output D2

Rack 3: input D3, output D3, etc.



If, on the other hand, the rack input has fewer channels than output channels (or vice versa), certain channels will go unused so that each rack begins with the same input and output channel number. In this example, rack input is mono, and output is 5.0. The resulting patching looks like this:

Rack 1: input D1, output D1–D5

Rack 2: input D6, output D6–10

Rack 3: input D11, output D11–15, etc.

## Routing Racks Automatically

SuperRack can automatically route input and output I/O channels to each rack in a session. Routing is applied to a pre-configured session with no existing I/O patches. Patching continues until all racks are routed or all I/O channels have been assigned.

To learn more about routing in SuperRack, please refer to [Part 5: Rack Window](#).



## Inserting Plugins

Each plugin rack has eight slots. Rack signal flow is from top to bottom.

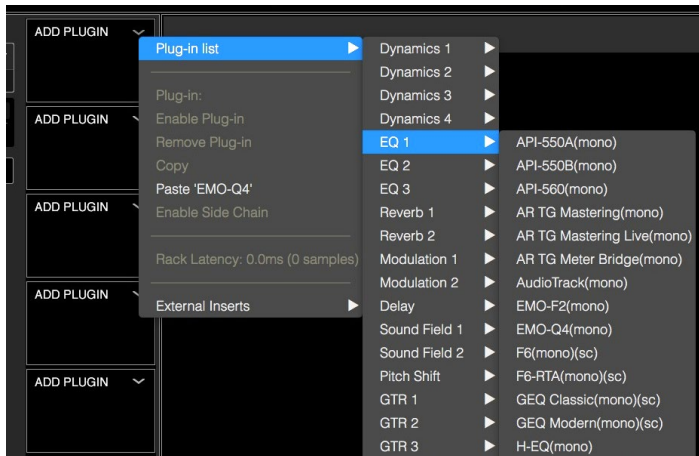

1. To insert a plugin in a slot, click on the down arrow (Rack window) or plus symbol (Overview window). This opens the drop-down Plugin menu.
2. Choose a plugin from the list. The input/output structure of the rack determines if a plugin can be inserted in the rack. If a plugin cannot provide a component that is compatible with the rack input/output structure, it will not appear in the menu (e.g., a 5.1 rack will not let you insert a stereo component). Also, certain plugins (e.g., mono-to-stereo) change the channel structure of the rack.
3. You can insert a plugin into any slot. The plugin's icon will appear in the slot. Click a plugin icon to open the plugin's interface in the plugin pane.

A plugin's rack position determines its place in the signal flow. You can change a plugin's position by dragging an icon up and down in the rack.

In this example, Abbey Road Chambers slides upward (blue path) to displace Doubler (red path).

Changing plugin order may result in a short audio drop. Wait for a convenient time to rearrange the rack.

Learn more about adding plugins to a rack in [Part 5: Rack Window](#)

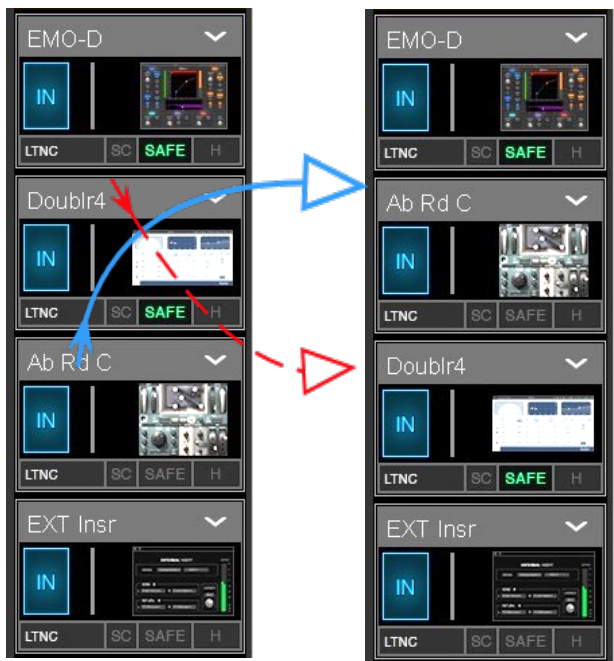

## Floating Panels

Certain panels can be detached from their docked locations and floated anywhere on the displays. This provides quick access to critical plugins and the controls you want to access regularly.

The following panels can be detached and floated:

- User Keys
- Hot Plugins
- Plugin control panes
- Snapshots notes
- Window tear-offs (Setup, Patch, Show, Rack, Overview 1 and 2)

### DETACHING A PANEL



Each detachable panel has a Float symbol at the top of its frame. Click this button to detach the panel from its dock. It can now be positioned anywhere on the SuperRack interface. When a panel has been detached from its original position, the Float symbol is blue.

Click anywhere else on the display and the floated panel will move backward and disappear. To keep a panel in the foreground, click the Pin button. Click the Float symbol again to return the panel to its dock.

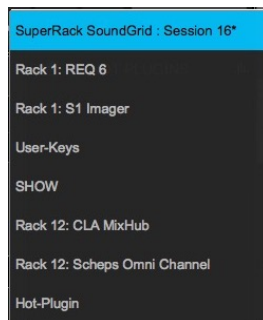

The Floating Panels drop-down menu on the right side of the Top Bar is a list of all detached panels. Select a panel or window and it will move to the front.

The name of the current session is shown at the top of the list.



## DETACHED PLUGIN PANES

To float a plugin's control interface, click on the Detach symbol at the upper-right corner of the of the plugin pane.

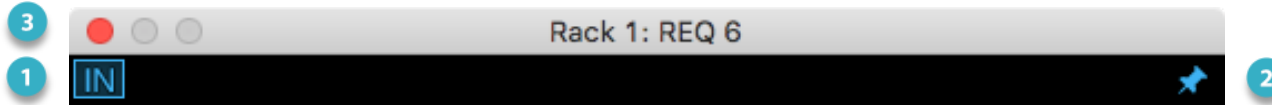
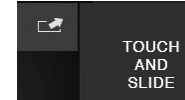

At the top of a floating plugin is a control bar. There are three control buttons:

- 1 Deselect the **IN** button to bypass the plugin.
- 2 Click the **Pin** button to keep the detached plugin visible when other plugins are detached. A pinned plugin remains visible in all SuperRack views.
- 3 **Close** the window and the floating plugin panel will return to the plugin pane. You can also close a window by clicking on the Detach symbol.

## HOT PLUGINS PANEL



The Hot Plugins panel provides instant access to selected plugin control panels. Up to twelve plugins can be assigned to the Hot Plugins panel.

- Any plugin in any rack can be assigned to the Hot Plugin panel.
- Hot plugin assignments are made in the plugin's drop-down menu.
- Hot Plugins can be within the scope of a snapshot, so you can have a different panel for each snapshot. Scope and Recall Safe are set in the Show window.
- Click on a Hot Plugin icon to display its complete plugin control panel.
- Right-click on a hot plugin to remove it from the current snapshot or from all snapshots.
- The Hot Plugins panel can show plugins as either icons or meters. To change between view modes, click the blue meter icon on the right side of the panel.
- A detached Hot Plugin panel can be displayed in a horizontal or vertical orientation. Click the ladder icon on the left side of the panel to toggle between these views.
- The plugin's name and rack number are shown above the icon.





## TEAR-OFF WINDOWS

There are five SuperRack windows: Setup, Patch, Show, Rack, and two Overviews. You can “tear off” one or more windows to spread SuperRack control over several displays. Click/drag downward, away from the Top Bar. A new window will appear. It can be positioned on any of your displays.

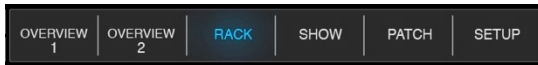

The original Window Selection Panel. All window tabs are available. In this example we will separate the Rack window from the other windows to create its own screen.



This creates a new screen containing only the torn-off window. Move this separated window to another display.

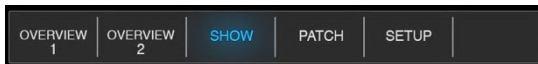

The main display can access any window except the secondary view. Repeat the procedure for additional displays.



The name of the panel will appear in the Floating Panels drop-down menu. Click on the window name and it will move to the front. Close the torn off window to return it to the default location in the Top Bar.



## *System Requirements*

Specifications for host computers, cables and connections, servers, display resolutions, and controllers can be found at [Waves Support](#).

### DISPLAY RESOLUTION

For maximum detail, SuperRack supports full HD (1920 x 1080). When SuperRack is launched, it will automatically rescale displays that have a different resolution. When you quit SuperRack, the display will return to its previous resolution setting.



## Part 2: Top Bar

At the top of the interface is a control ribbon called the Top Bar. It plays an important role in controlling SuperRack. We suggest that you read this chapter before moving on.

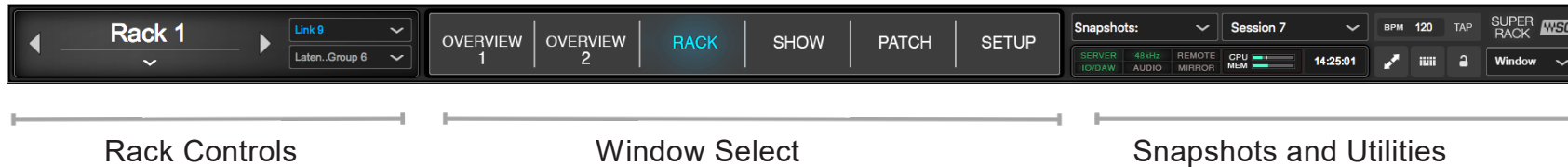

The Top Bar is visible from every SuperRack window. It includes the menus, information boxes, system feedback, and navigation tools that you need all the time.

The Top Bar is used to:

- Navigate to and select a rack
- Assign a rack to link groups
- Assign a rack to a latency alignment group
- Save, load, and manage rack presets
- Save and load sessions
- Switch between windows
- Load and store snapshots
- Monitor DSP and memory status
- Set and monitor BPM
- Lock the mixer interface and access on-screen keyboard
- and other functions



## Left Panel: Rack Controls

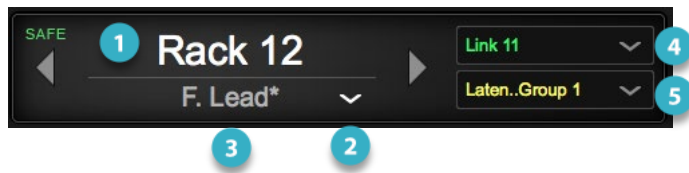

Use this section of the Top Bar to select a rack, assign it to a link group and a latency group, manage rack presets, and open and save sessions and templates.

### 1 Rack Name

The Rack Name box displays the name of the selected rack. Left and right arrows move the selection to the previous or next rack. You can move directly to a rack using the Racks menu on the right. To rename a rack, double-click on the Name box and then type. If the rack is set to Recall Safe, the word “SAFE” appears.

### 2 Racks Menu

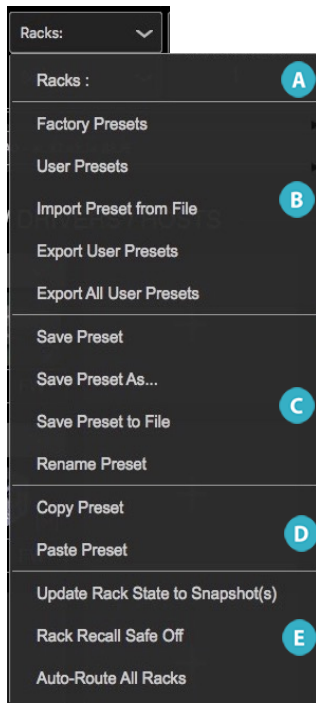

The Racks menu is used to load, save, import and export, and copy and paste the presets for the selected rack. A Rack Preset is a complete description of a rack (i.e., I/O patching, rack structure, and plugin settings).

A rack’s settings can be copied from one rack to another. Factory presets can be loaded, modified, and then saved as new user presets. Presets can also be copied and exported as files, which can then be imported to another SuperRack host. This enables moving individual racks between sessions.

The Racks Menu is divided into five sections, indicated here with letters.



## 2a RACK SELECT

Navigate directly to a rack using this submenu.

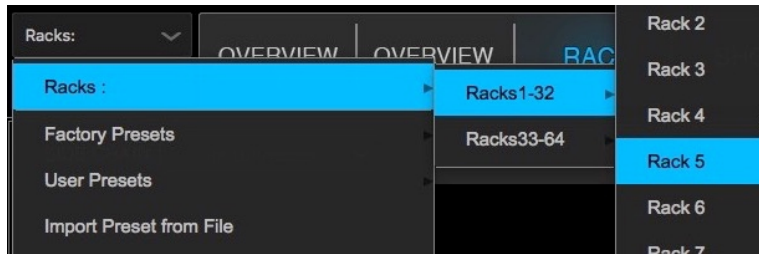

## 2b RACKS MENU: IMPORT AND EXPORT PRESETS

### FACTORY PRESETS (LOAD)

Displays a list of presets supplied by Waves. These provide starting points for many setups. Factory presets cannot be saved. Instead, modify the preset and save it as a user preset. **Empty** removes all plugins from the rack.

### USER PRESETS (LOAD)

Loads a user-created rack preset that has been saved in the current session or imported from another. To delete a user preset, hold Ctrl/Alt before opening the Preset menu. Select the preset and it will be deleted. This cannot be undone.

### IMPORT PRESET FROM FILE

Loads a single preset that has been saved as a file, not as part of the session. Imported presets are added to the User Presets menu and then saved as part of the session.

### EXPORT USER PRESETS

Creates a file with all user presets for the entire session, not just those of the selected rack. These are stored as one xps file that can be saved to other media.

### EXPORT ALL PRESETS

Exports a file that contains the presets—not just the user presets—of all channels in the session.



## 2c RACKS MENU: SAVE AND COPY PRESETS

### **SAVE**

Saves the current condition to the loaded preset, overwriting it.

### **SAVE TO USER PRESETS**

Creates a new user preset. These presets are saved as part of the current session. Consider this a “Save As” function.

### **SAVE PRESET TO FILE**

Copies the current rack condition and creates a file that is saved at a user-defined location. This preset file can be imported to any session (the extension is xps). Unlike user presets, these are not embedded in the session.

### **RENAME PRESET**

Changes the name of the current rack preset.

## 2d RACKS MENU: COPY/PASTE PRESETS

### **COPY PRESET**

Copies the current rack condition to the clipboard. A copied rack preset can be pasted to any other rack in the current session.

### **PASTE PRESET**

Pastes the copied rack preset from the clipboard to another rack. A dialog box lets you choose what rack information will be replaced in the target rack and what will be left unchanged.



Note: Before you paste a rack preset to another rack, make certain that the plugins and their sequence is the same on the source and target racks. Loading a preset to a rack that uses a plugin chainer order that's different from that of the current rack will apply the new preset to all scenes. This action cannot be undone.



## 2e RACKS MENU: RACK RECALL AND AUTO ROUTE

### **UPDATE RACK STATUS TO SNAPSHOT(S)**

Copies the current rack's settings to selected snapshots in the session. A dialog lets you to select the snapshot(s) you want to copy and paste.

### **RACK RECALL SAFE OFF**

Sets the recall safe condition of the rack. When the rack is in a Recall Safe condition, a small SAFE icon is shown below the Rack name in the Top Bar.

### **AUTO-ROUTE ALL RACKS**

Automatically creates routing for all racks in a session.

## 3 Current Preset

Displays the rack preset if one is loaded. An asterisk (\*) indicates that the preset has been modified since it was loaded.



## 4 Link Group Assignment

Use the Link Group Assignment menu to assign the selected rack to one of sixteen link groups. When racks are linked together, the identical parameter controls of all members of the group move together. Variable controls are linked relatively: if controls are set to different values before they are linked, they will move together, and their offsets will be preserved.

Controls that are linked together:

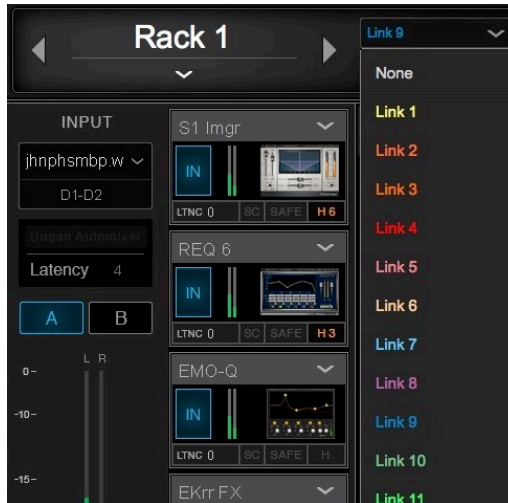

- A/B input and output selection
- Input and output gain
- Plugin In/Out
- Mute

Plugin parameter controls are not linked.

The Link Group Assignment box displays the name of the link group that the rack is assigned to. A link group can include up to 64 racks, but a single rack can be a member of only one link group. The Patch window provides an overview of all link patches in the session and allows you to make many assignments simultaneously.





## Latency Group Assignment



Use the Latency Group Assignment drop-down menu to assign the selected rack to a latency group. Latency groups are used to align the delays of several racks and to set the delay of a group of racks.

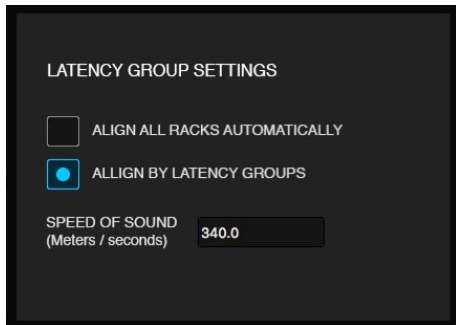

To establish latency groups, the Latency Group setting in the Settings page (Setup>Settings) must be set to “Align by Latency Groups.” Setting “Align All Racks Automatically” aligns *all racks* to match the rack with the greatest latency. Latency is explained in detail in the [Patch Window section](#) of this user guide.



## Center Section: Window Selection Tabs



Use these tabs to select one of the six SuperRack windows.

## OVERVIEW 1 AND OVERVIEW 2 WINDOWS

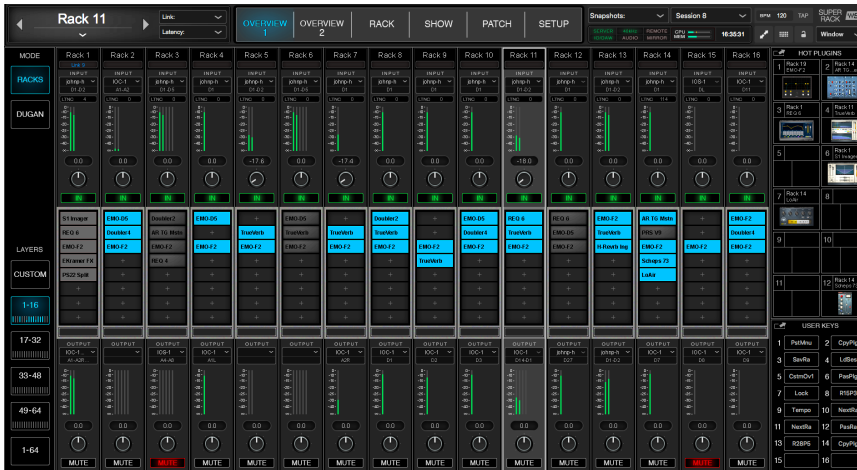

The two Overview windows provide a broad look at your session. Most rack functions can be controlled here. Plugins are added, removed, disabled, and bypassed in the small plugin rack. Click a plugin's icon to access its full interface. Drag any plugin icon to move it from rack to rack or within its own rack.

There are five Overview layers: four layers with 16 racks and one layer that displays the inputs and outputs of all 64 racks.

## RACK WINDOW

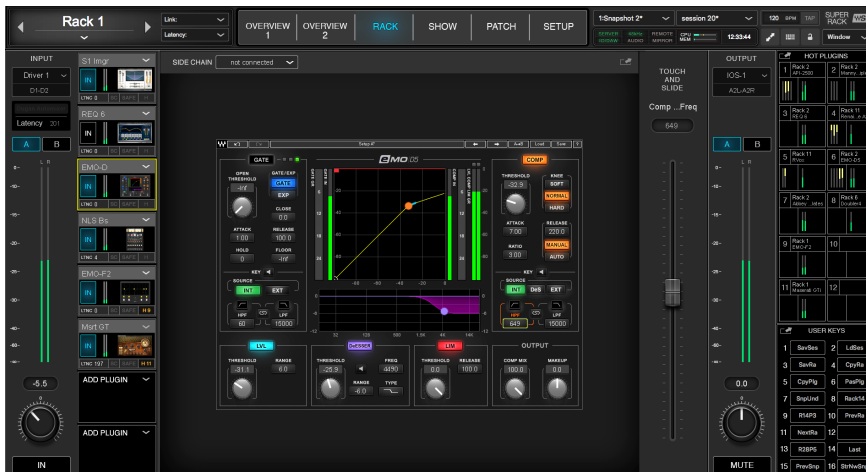

The Rack window is a detailed view of the selected rack. It's used to control plugins, assign I/Os, set input and output levels, and recall hot plugins and user-assigned keys. When a plugin in the plugin rack is selected, its complete interface is displayed in the middle of the screen.



## SHOW WINDOW

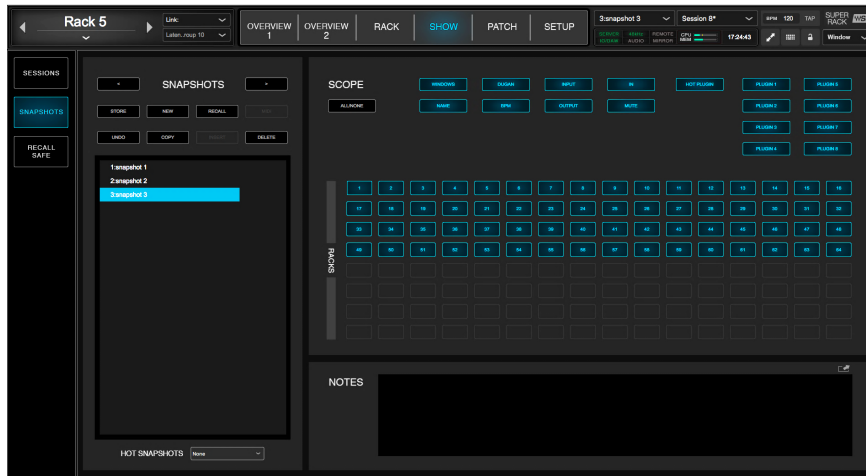

The Show window is SuperRack's filing center, where snapshots and sessions are managed.

The window consists of three pages:

- Sessions
- Snapshots
- Recall Safe

## PATCH WINDOW

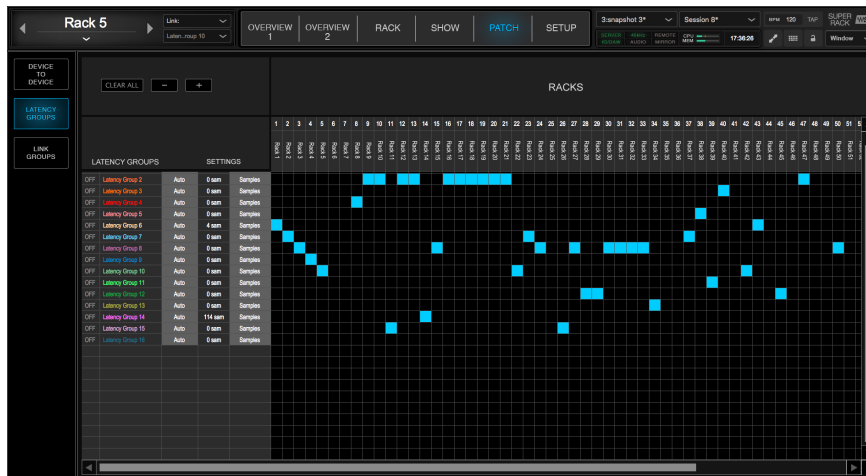

This is a patch bay for connecting between devices on the SoundGrid network, managing latency groups, and overseeing link groups.

It's a convenient way to view all the members of latency groups and link groups.



## SETUP WINDOW



The Setup window is where you connect SuperRack to the SoundGrid network, assign servers, I/O devices, drivers, and control protocols, and set preferences.

### Tearing Off Windows for Multiple Displays

SuperRack can be controlled with up to four displays. This enables you to manage several parts of a session simultaneously. Create additional display views by “tearing off” tabs from the original screen display. Click and drag downward, away from the Top Bar. A new window will appear.

This is demonstrated in the [Floating Panels](#) section.



## Right Panel: Snapshots and Utilities

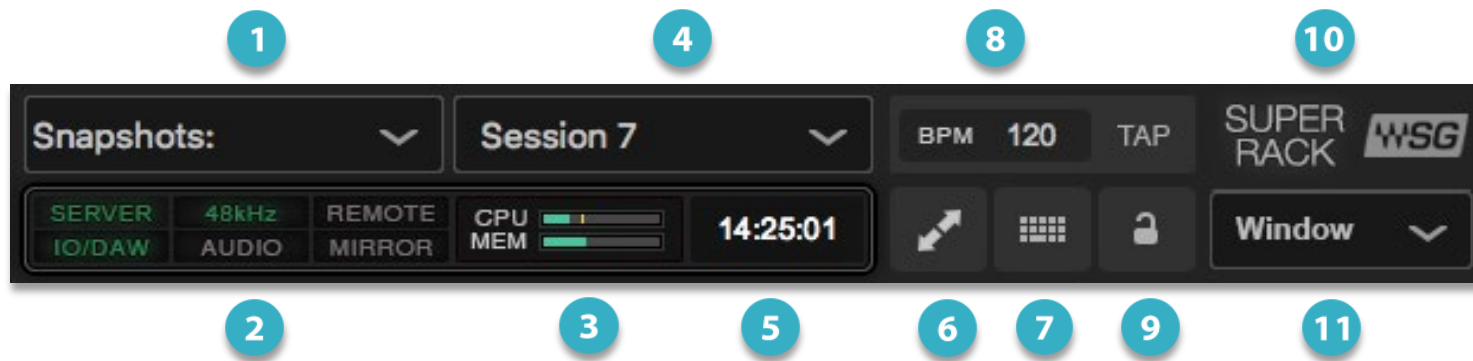

### 1 Snapshot Menu

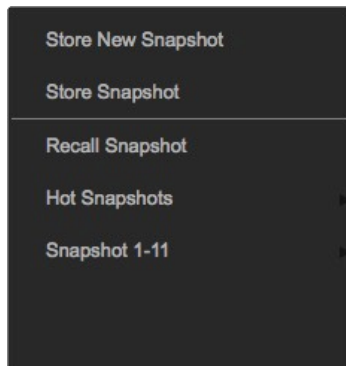

The Snapshot menu is used to store and recall snapshots for all current parameters. The name of the current snapshot and its index number are displayed in the box. If a scene has been modified since it was recalled, its name is followed by an asterisk (\*). A session can hold up to 1024 snapshots.

Snapshots are discussed at length in the [Snapshots](#) section of the Show chapter.

#### STORE NEW SNAPSHOT

Creates a new user-named snapshot based on the current SuperRack condition.

#### STORE SNAPSHOT

Overwrites the current snapshot with the current SuperRack condition.

#### RECALL SNAPSHOT

Directly recalls a snapshot based on its place in the snapshot list. Type an index number and the corresponding snapshot will be recalled.



## HOT SNAPSHOTS

Provides immediate access to up to eight “Hot” (i.e., high-priority) snapshots.

## SNAPSHOTS LIST (1–32; 33–64;...968–1024)

Shows all snapshots associated with the session, in banks of 32 snapshots. Maximum number of snapshots per session is 1024.

Learn more about how SuperRack handles snapshots in Part 7: [Show Window](#).

## 2 Status Panel

### PROVIDES CRITICAL SYSTEM FEEDBACK:

INDICATOR	COLOR	STATUS
SERVER	Green	Server is functioning properly
	Red	Fault with the server
IO/DAW	Green	All I/Os and DAW
	Red	Problem (e.g., DAW or I/O is disconnected)
SAMPLE RATE	Green	All devices are in sync
	Red	One or more devices are out of sync
REMOTE	Green	SuperRack is being controlled externally
	Orange	SuperRack is being controlled externally and console Touch and Turn is engaged
	Red	Something is wrong with the remote (e.g., disconnected)
MIRROR	Green	Mirroring is established
	Red	Mirroring is broken



### 3 CPU and Memory Displays



The CPU/MEM box shows:

- CPU load on the SoundGrid server
- Local Memory usage

The **CPU** indicator bar displays *average* CPU of all cores. The small line shows the *peak* load of the core with the highest CPU. The color of the bar indicates server CPU status. CPU values are shown numerically in the Inventory page.

METER	INDICATION
<b>GREEN BAR</b>	CPU load is less than 85%. It is likely that more plugins can be added.
<b>YELLOW BAR</b>	CPU load is 85%–95%. To avoid potential network overloads, you should try to redistribute your processing load by moving or disabling certain plugins.
<b>RED BAR</b>	The bar turns red when CPU exceeds 95% or when the SoundGrid network is not locked.
<b>GRAY BAR WITH “NA” DISPLAYED</b>	Server is not present or is malfunctioning.
<b>ORANGE DSP LINE</b>	Displays peak CPU of the core with the greatest CPU load. The bar turns red when peak load of the busiest core exceeds 95%.



A high CPU warning indicates that SuperRack is requesting data at a rate that the SoundGrid server cannot currently provide. Here are two common CPU overload conditions and suggested solutions.

<b>PROCESSING OVERLOAD</b> (momentary or constant)	<b>POSSIBLE SOLUTION: DISABLE SOME PLUGINS</b> This is the most common cause of CPU overload. First remove some CPU-heavy plugins. If this helps, try to restructure your racks so that you can manage with fewer of these plugins.
<b>HIGH NETWORK USAGE</b> (channels over the network)	<b>POSSIBLE SOLUTION: INCREASE SERVER NETWORK BUFFER SIZE</b> The Server Network Buffer size is set in the Server drop-down menu in the System Inventory page. Larger buffers will result in more stability but greater latency.

#### MEMORY DISPLAY

The Memory Overload meter (MEM), located just below the CPU meter, shows the amount of **local** memory that SuperRack is using as a percentage of what has been allocated to it by the host OS.

#### 4 Session Menu

Used to open and save sessions and templates:

**Session:** Displays the name of the current session.

**Open Session:** Opens a session from a file.

**Open Template:** Opens a session template, which you will save as a regular session.

**Save Session:** Saves the current session, overwriting the previous save to that file (in other words, a regular save).

**Save Session As:** Saves the current session to a new file.

**Save Template:** Creates a new SuperRack template from the current session.





## Utilities

- 5** **CLOCK**

The clock displays the current time on the host computer. When MIDI Control is used, this box can display MIDI timecode.
- 6** **FULL SCREEN MODE**

Activates the full screen mode. Click again or tap ESC to return to regular view.
- 7** **ON-SCREEN KEYBOARD**

Accesses the operating system's touchscreen keyboard. Use this to enter text information on a touchscreen display when a hardware keyboard is not available.
- 8** **GLOBAL TEMPO SECTION**

This section sets the tempo for all relevant plugins. By default, tempo-based Waves plugins are in a "tempo listen" state. Their tempo rates will fix to this value. Alternatively, click a rhythm on the Tap button. These taps are averaged to create a tempo value. You can also enter a numeric value in the box below. The tempo light flashes at the designated tempo.
- 9** **LOCK BUTTON**

Click the Lock button to prevent unintended changes to the session during a show. The scope of Lock is established in the Settings page.
- 10** **GET INFO PANEL (CLICK ON WSG SUPER RACK LOGO)**

Click this button to open the SuperRack information panel. This view includes the version of SuperRack that you're running, as well as a link to the user guide.
- 11** **FLOATING PANELS LIST**

This is a list of currently detached panels (e.g., hot plugins, user keys, plugins, windows). Select a panel from the drop-down menu to navigate directly to it. The name of the session is shown at the top of the list. Click on this name to return to the main view.

Refer to the [Floating Panels](#) section to learn more.



# Part 3: Setup Window

The Setup window is used to monitor the network, set preferences, and assign devices. There are two pages.

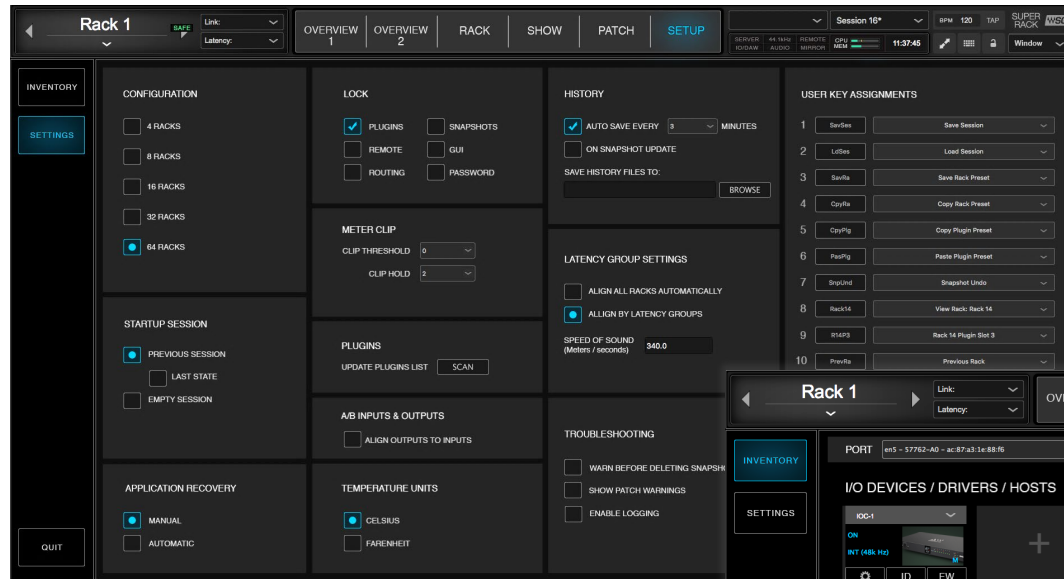

## Settings Page (left)

Use to set the number of racks in the session, set preferences, and assign user keys.

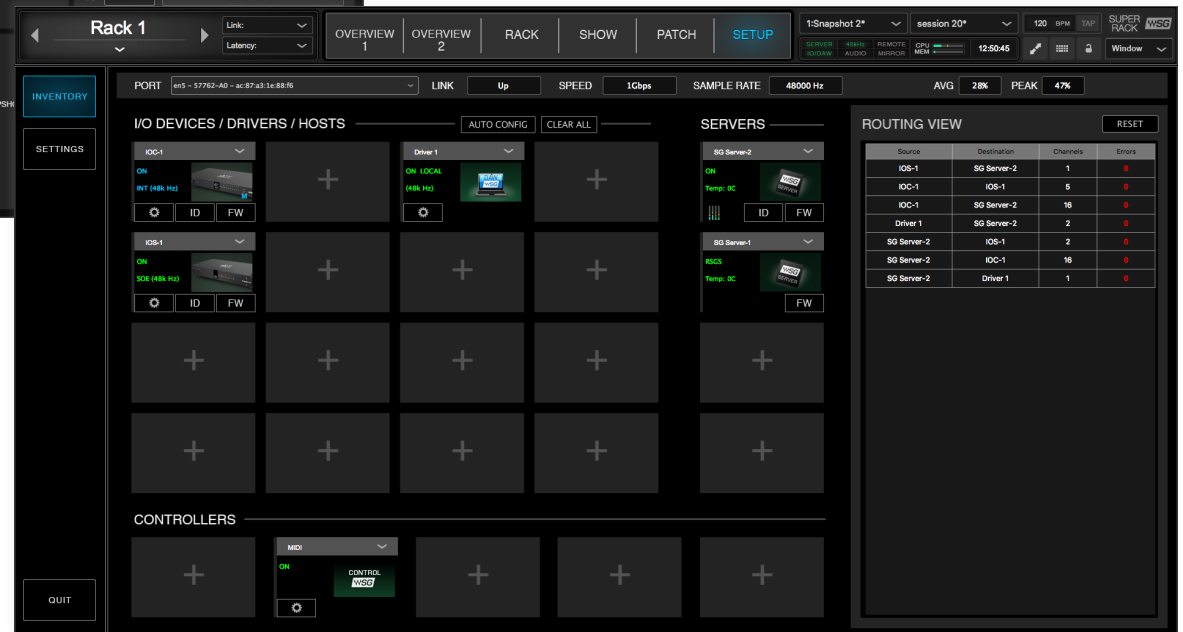

## Inventory Page

Assign I/Os, drivers, servers, and controllers. Configure and monitor the SoundGrid network.

Use the buttons on the left sidebar to move between Setup pages.



## Assigning Devices: Inventory Page

The **Inventory** page is used to set up the SoundGrid network and to assign and manage devices. Use the top part of the page to establish and monitor the network. Use the bottom part the page to assign network devices, servers, and controllers to SuperRack SoundGrid.

The screenshot displays the 'Inventory' page of the SuperRack software. The interface is dark-themed and includes several sections:

- Top Bar:** Shows network status (PORT: en5 - 57762-A0 - ac:87:a3:1e:88:f6), LINK (Up), SPEED (1Gbps), SAMPLE RATE (48000 Hz), CPU (27%), and MEM (45.6%).
- I/O DEVICES / DRIVERS / HOSTS:** A grid of device cards. Each card shows a device name (e.g., IOS-1, IOC-1, Pro Tools Aggregate I/O, DIGIo: SD IO 64CH-1), status (ON or OFFLINE), and sample rate (e.g., INT (48k Hz), SDI (48k Hz), DIG (48k Hz), INT (0 Hz)). There are buttons for settings, ID, and FW.
- SERVERS:** A grid of server cards. Each card shows a server name (e.g., SG Server-1, SG Server-2), status (ON), and temperature (e.g., Temp: 0C, Temp: 47C). There are buttons for ID and FW.
- CONTROLLERS:** A grid of controller cards. Each card shows a controller name (e.g., MIDI Controller), status (ON), and a 'CONTROL' button with the WSG logo.
- ROUTING VIEW:** A table showing the network topology.

Source	Destination	Channels	Load	Errors
IOS-1	IOC-1	7	0	0
Driver 1	IOC-1	2	0	0
Driver 1	SG Server-2	3	0	0
SG Server-2	IOS-1	2	15	0
SG Server-2	Driver 1	2	0	0



## Network Control Section (Top)

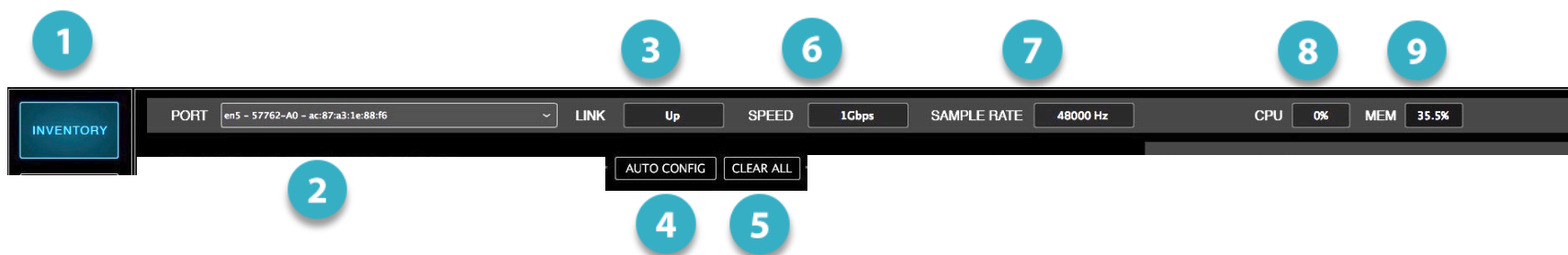

### 1 INVENTORY/SETTINGS PAGE SELECTOR

### 2 LAN PORT DROPDOWN MENU

Use this menu to select the host computer's LAN port that is connected to the SoundGrid network switch. The name of the selected port is shown in the window. We recommend that the SoundGrid network is used exclusively for SoundGrid devices. Use another port for other network functions.

### 3 LINK STATUS

Reports the status of the Ethernet connection to the host computer.

Options: UP / DOWN / INVALID

### 4 AUTO-CONFIGURE

A SuperRack system can be configured manually or with the aid of this auto-configure tool. Auto-Configure surveys the network for available I/O devices and assigns them to SuperRack. Auto-Configure requires that the correct LAN port is selected. If you forget to select the port, or if you chose incorrectly, you will be prompted to select the correct port.



- 5 CLEAR ALL**  
Removes all assigned I/O devices, servers, and drivers.
- 6 SPEED**  
Reports the speed of the SoundGrid network: 100 Mb/sec, 1 Gb/sec, N/A.
- 7 SAMPLE RATE**  
Reports the sample rate of the SoundGrid network.
- 8 CPU**  
Displays the percent of CPU processing load on the server, averaged across all cores. Refer to the multi-core CPU displays on the server icons for core-by-core CPU status.
- 9 MEMORY (MEM)**  
Shows memory use on the host computer as a percentage of the memory set aside by the OS.



## Device Racks

All SoundGrid devices— I/O devices, drivers, servers, and controllers—are assigned in these racks: There are sixteen I/O device rack slots, each of which can hold one device. You can assign I/O devices from within your local network or from remote systems with shared devices. Device sharing is discussed in the next section.

A device can be assigned to any rack slot. Sequence order is not important.

The screenshot displays the SuperRack configuration interface. It features a main grid of 16 I/O device slots arranged in a 4x4 layout. The top row contains four slots: M-1 (ON, SOE 48k Hz), IOS-1 (ON, SOE 48k Hz), johnp-hsiembp.waves.com (ON LOCAL, 48k Hz), and an empty slot with a plus sign. The second row contains IOC-1 (ON, INT 48k Hz) and three empty slots with plus signs. The third row contains MGO-1 (OFFLINE, INT 0 Hz) and three empty slots with plus signs. The fourth row is entirely empty with plus signs. To the right, the SERVERS section contains two slots: SG Server-2 (ON, Temp: 43C) and SG Server-1 (RSGS, Temp: 0C). At the bottom, the CONTROLLERS section contains a MIDI CONTROL WSG device and three empty slots with plus signs. Numbered callouts (1-6) highlight specific elements: 1. A horizontal line across the second row of the I/O grid. 2. A gear icon for the SOE (48k Hz) device. 3. A gear icon for the WSG I/O device. 4. A gear icon for the johnp-hsiembp.waves.com device. 5. A gear icon for the SG Server-2. 6. A gear icon for the MIDI CONTROL WSG device.



## DEVICE RACK ELEMENTS

### 1 I/O DEVICE RACKS

Sixteen identical rack slots for hardware I/O devices and software I/Os (drivers).

### 2 ASSIGNED HARDWARE I/O DEVICES

Any device in the local SoundGrid network, as well as devices on other connected SoundGrid systems, can be assigned to a rack slot.

### 3 OFFLINE DEVICES

Devices that are unavailable can be configured offline. When the hardware device becomes available, all device settings, including routing assignments, will be applied to the hardware device.

### 4 SOFTWARE DEVICE (DRIVER)

A driver from the host computer can be assigned just like a hardware device.

### 5 SERVERS RACK

You can assign one primary server and one redundant server. Servers can be assigned only to the local host. They cannot be assigned to other hosts.

### 6 CONTROLLERS RACK

Use these rack slots to assign controllers to SuperRack.



## ASSIGNING I/O DEVICES

To add a device, click on the plus (+) sign on an empty device slot. This opens the I/O Devices drop-down menu. There are three categories of assignable devices to choose from.

- Network All working devices (hardware I/Os and drivers) attached to this SoundGrid SOE network
- Local The local driver of the host computer or another host
- Offline Templates of devices that can be used to create sessions without a server and I/O devices

To select an I/O device, open the Network submenu and choose a device.



The names of available devices are white.

Assigned or unavailable devices are grayed out.

A driver on the host computer driver is shown at the bottom and can be assigned in the same manner as hardware I/Os.

An assigned I/O device—hardware or software—appears in the rack slot.





## I/O DEVICE ICON INDICATORS

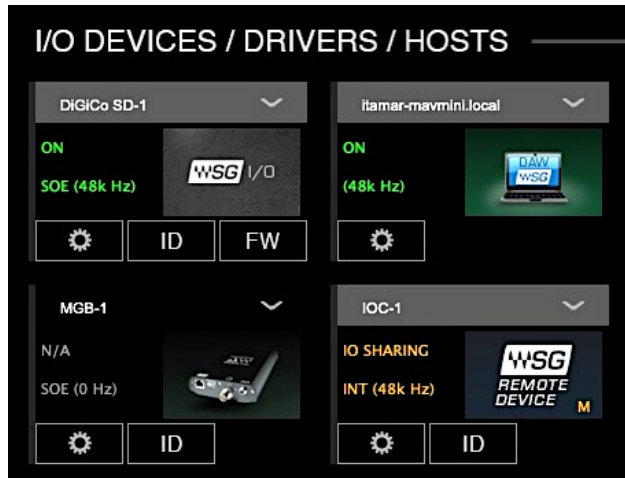

Once a device is assigned, the color of text on the icon provides device status information.

### Clock Indicators

Font Color	Indication
Green	SOE <b>slave</b> device is working properly and is owned by this user. <sup>1</sup>
Blue	The SOE <b>master</b> device is working properly and is owned by this user. A blue “M” indicates that this device is the clock master of the local SOE network.
Gray	Device is disconnected. Icon text: "N/A."

### Other Color Codes

Red	The device is not available (e.g., disconnected, in the process of firmware re-flashing, owned by someone else). This state overrides other settings if there is a conflict. Device icon text: "Not Available: ( <i>owner's name</i> ).". Red also indicates an offline device.
Orange	This is a shared device that you can assign to your inventory and patch to its free I/O channels.

<sup>1</sup> SoundGrid uses Ethernet to stream audio between devices. Clock synchronization is also carried over Ethernet. This method of providing clock is called Sync over Ethernet (SOE). The local network of devices clocked to the same system is called the “SOE Network.”



## More Indicators That Describe the Device's Status

Item	Possibilities	Function
Device Name	Text entry	The device product name followed by a number (e.g., "MGB-1") is the default name. Change the device name by double-clicking on its Name box.
Device Status	On	Device is active.
	NA	Device is unavailable. Likely causes: <ul style="list-style-type: none"> <li>• Device is assigned to another system.</li> <li>• Device or firmware is incompatible with current SoundGrid software.</li> <li>• Device was previously assigned to this user but is not currently connected.</li> </ul>
	Offline	A virtual device is assigned to this rack slot for offline preparation of sessions without I/Os connected. All device patching will be maintained when the session is launched on a complete system.

## Device Clock Status

Icon Item	Possibilities	Indications
Clock Source	INT, SOE, AES, WC, DigiLink	Clock source of this device
Sample Rate	44.1, 48, 88.2, 96 kHz	Sample rate of device
Clock Master	M (master) / (blank = slave)	Identifies the device as the clock master of the SOE network.



Three buttons at the bottom of the slot provide access to hardware setup controls.



Item	Purpose	Action
Gear button	Control Panel access	Click to access device's control panel to adjust preamps, configure channels, and control its clock. This button is grayed out if the device does not support a control panel.
ID	Locate hardware device	Activates a light on the front panel of the hardware device associated with the icon.
FW	Firmware status and re-flash start	Click the FW button to start firmware update.
Gray	Firmware is compatible with installed mixer software.	
Blue	Firmware is compatible with installed mixer software, but a newer version exists. Firmware should be updated as soon as possible.	
Red	Firmware is not compatible or is out of date. Click the FW button to re-flash device hardware.	



## I/O DEVICES MENU ITEMS

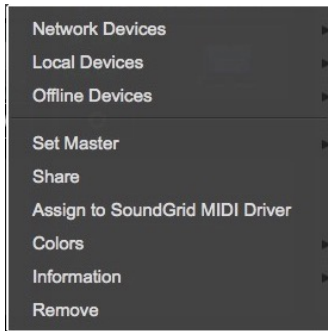

Once a device has been assigned to a slot, the I/O Devices drop-down menu expands.

Menu Item	Possibilities	Function
Set Master (hardware I/O)	Open a list of all assigned hardware devices.  Designate one device as the local SOE clock master.	Sets a device as the SOE network clock master—all other devices become slaves and their clock sources are switched to SOE. The letter “M” and blue text in the slot indicate that the device is the clock master of the local network. Slaves are colored green. Any SoundGrid-complaint I/O device can be an SOE slave or master.
Share	Share/Don’t share.	Allows other systems to assign the device and enable I/O sharing. See <a href="#">Working with Multiple Systems</a>
Assign to SoundGrid MIDI Driver	Checked/Unchecked	Assigns any MIDI-port-equipped I/O device to the SoundGrid MIDI driver. The device can then serve as a port for other MIDI devices. The assigned device appears to MIDI controllers as “SG Device I/O.”
Colors	Several colors, plus no color	Adds a color strip to the edge of the selected device. This color-coding appears with the device in the Patch window, making it easier to identify, especially if there are several I/O devices of the same type.
Information		Reports details about the device. Supply this information to Waves technical support when investigating hardware-related faults.
Remove		Removes the device from the rack.



## SETTING CLOCK MASTER

You can usually assign the clock master of the SOE network directly from the I/O Devices menu.

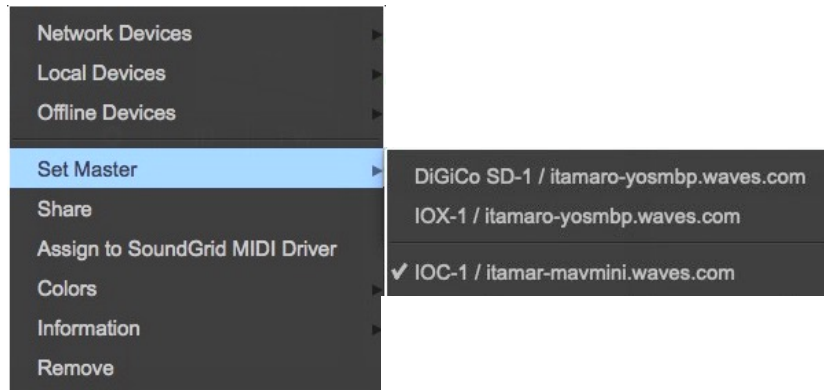

1. Select “Set Master.” This opens a drop-down menu of all I/O devices assigned to the SOE network.
2. Choose a device. Its icon changes to blue and “M” appears. Other assigned devices will become slaves.

The clock slave/master assignment of certain I/O devices cannot be changed directly from the SuperRack interface. One example is when an I/O device is receiving clock from another device via word clock or AES. In this case, the I/O clock cannot be set from the Inventory page, but rather from its own control panel.

Consult the user guide for your I/O devices if you need to change clock settings using the control panel.



Certain device menu items apply only to drivers.

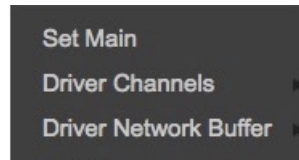

Menu Item	Possibilities	Function
Set Main	Main: checked/unchecked	Assigns this driver as the main driver or the backup (usually a DAW/recorder). If more than one driver is selected, they become the backup drivers.
Driver Channels	Range: 32–128 channels, and Auto Default: 32 channels	Sets the number of channels assigned to the SoundGrid ASIO/Core Audio driver. A higher number of driver channels can increase network load and may require more buffering. AUTO assigns the maximum number of driver channels available, based on the number of input and output device channels.
Driver Network Buffer	(Values in samples) Range @ 44.1–48 kHz: 104, 144, 192, 240, 288, 336, 384, 432, 480, 528, 576, 1024 Range @ 88.2–96 kHz: 208, 256, 304, 352, 400, 448, 496, 544, 592, 640, 1088	The network buffer helps the OS send synchronized information between the ASIO/Core Audio drivers and the I/Os through the network port. When many channels are going in/out of the driver(s) to several destinations, the Driver Network Buffer size may need to be increased to reduce the possibility of audio drops or artifacts as a result of overloading the network port driver.

**!** All host computers on the SoundGrid network should have the same up-to-date version of SuperRack and SoundGrid Studio software installed. Device firmware should match the host applications. You can download and install the latest versions from Waves Central.



## WORKING WITH MULTIPLE SYSTEMS



A single SuperRack system that is networked with a soundcard, a server, and perhaps other I/O devices is a closed system. Only devices that are members of this local SoundGrid network can be assigned.

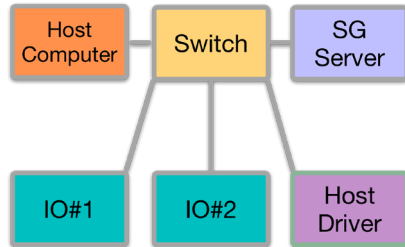

## CONNECTED SYSTEMS

Multiple SuperRack systems can be linked by connecting their Ethernet switches. This enables hosts within this “super system” to build private networks. Users can assign devices from any other SuperRack system. These assignments behave in the same manner as local Inventory assignments: devices assigned to any host are available only to that host until they are un-assigned. Other users will see the devices in their Inventories, but they will be grayed out and unavailable.

A SuperRack SoundGrid system does not need the permission of other systems to assign an available device to its Inventory.

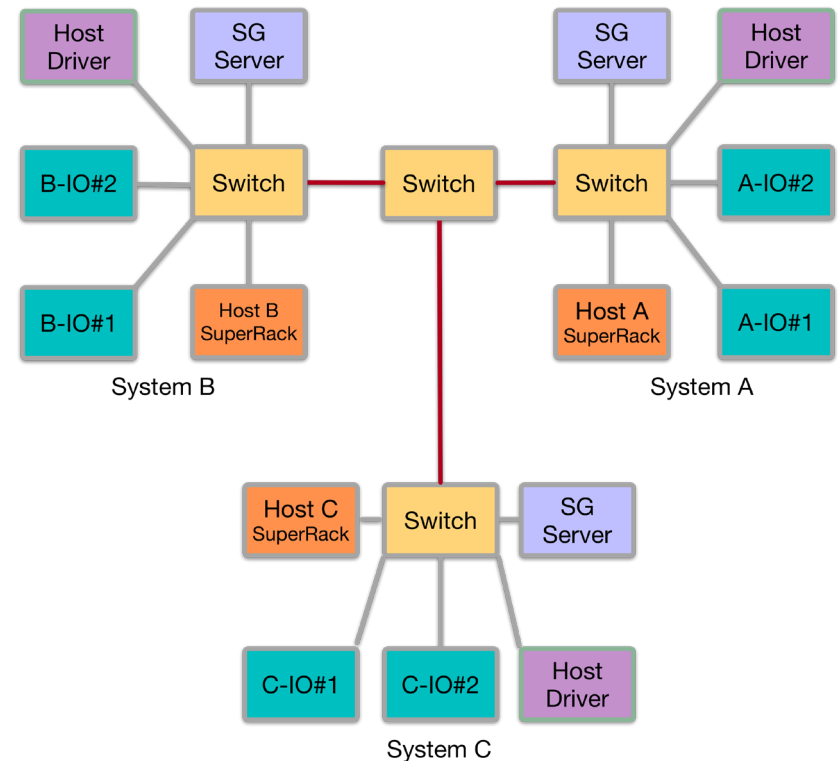

## INVENTORY IN SUPER SYSTEMS

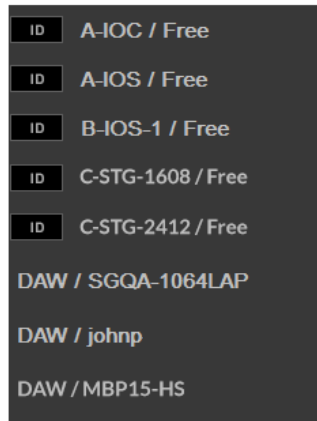

All devices in a super system—whether assigned to a host or not—are displayed in the Device menu of each independent system’s Inventory (left). In this example, there are five I/O devices. The host of each device is shown, followed by the device name. The name of each host’s local driver is also shown.

A host that has assigned a device to its Inventory is the **manager of that device**. When a device is removed from a host, the device becomes Free and it can be assigned by any other host, which in turn becomes its manager.

## SHARING A DEVICE

Device sharing enables different hosts to assign devices that are already claimed by other hosts and route available device I/O channels. A host that patches I/O channels from a device that’s been assigned to another host (the manager) is called the **client of that device**. A host can be a manager of some devices and a client of others. A device can have several clients, within the limits of the device’s maximum output to the network. Each destination establishes a direct connection from the shared I/O device.

For example, a 128-input MGB patched to four hosts will use up the 1 Gb network capacity of the SoundGrid network.<sup>2</sup> In this case, the device will output 128 x 4 channels=512 channels (at 48 kHz).

---

<sup>2</sup> DiGiGrid MGB and MGO MADI-to-SoundGrid interfaces are used to connect MADI-enabled devices to a Waves SoundGrid network. The MGB unit is equipped with MADI BNC connections; MGO is equipped with MADI optical connections. Refer to the MGO user guide, which is available on the [Waves Manuals download page](#).





## SETTING UP DEVICE SHARING



For other SuperRack systems to access a device in your Inventory, you must enable sharing for the device:

- Select the assigned device you wish to share.
- Select Share from the device's drop-down menu. The sharing symbol will appear on the device icon.

Only the manager of a device can activate its sharing.

Other systems can now assign the I/O device to their Inventories and patch available I/O channels. Output I/O channels patched by the manager cannot be shared with other systems until the device's manager releases the patches or removes the device from its inventory.

## CLOCKING CONSIDERATIONS WHEN SHARING

When a device is shared by two systems, both systems must be locked to the same clock master. If a client system assigns a shared device that's part of a system that has a different clock source, something must be done to rectify the difference.

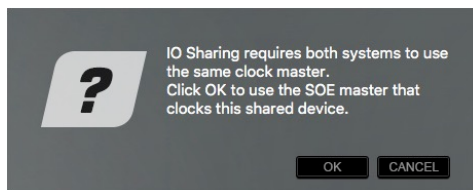

When assigning a shared device whose clock source is not the same as that of the client system, this prompt will appear (left). Click OK to set the clock of the client system as your system's clock. The shared device, or its master clock, is now the local SOE clock master for all the devices in your local SoundGrid network.

If this clocking configuration is not acceptable, cancel from the dialog. Create a clock source that is common to the host system and the user and then start sharing.



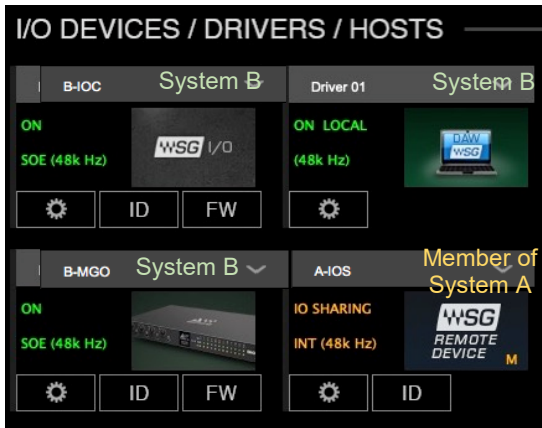

In this example, device **A-IOs**, which is a member of SuperRack system **A**, is shared with SuperRack system **B**. This means that the device is now assigned to two independent systems (A and B) that must be synchronized to the same master clock device. When A-IOs is assigned, it becomes the system B clock master—all other devices become SOE slaves.

It is possible to assign another device as the clock master while using a shared device, as long as all systems and devices share the same clock.

Use each system's **Set Master** menu to re-assign clock masters. Select the same device in both systems, if possible, and the clock will be common to both systems.

If this is successful, the shared device can now be a slave in the client system.



If the shared device cannot synchronize to the new clock, it will be unavailable for sharing by that host. Other SuperRack hosts in the super system may be able to sync to the shared device if they can adjust their clocks accordingly.



A shared device can be a slave or the clock master of its *own* SOE network, indicated by the **M** on the shared device's icon (left). On the right, the device is still the SOE master of the system it's being shared with but is a slave within its own system.

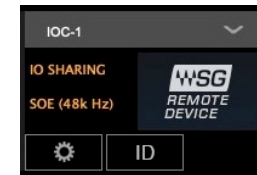

When devices from more than two systems are assigned to a system's inventory, all systems must be locked to the same master clock device.



Note: Changing the master clock assignment in a system that includes shared devices will result in a clock reset in all associated systems. This causes a short audio dropout.



## Assigning Servers

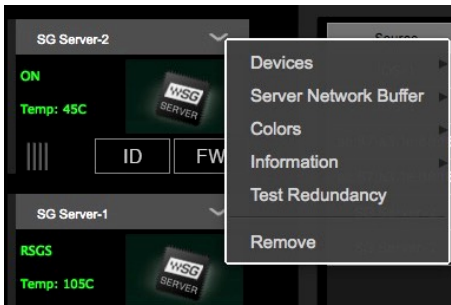

The Servers rack is used to assign, remove, and configure a SoundGrid server. Click on the arrow to open the Servers drop-down menu. The servers are identified like this:

- Type = server type: model and revision (CPU generation)
- Name = a user-set friendly name

Menu Item/Indicator	Possibilities	Function
Devices	All available servers	Displayed: User-friendly name; Server type: model and revision (CPU generation) Click on a server name to assign it. Unavailable servers are grayed out.
Server Network Buffer	Range @ 44.1–48 kHz: 40-96 samples Default: 40 samples (0.8 ms) Range @ 88.2–96 kHz: 80-192 samples. Default: 80 samples (0.8 ms)	This sets the amount of time it takes for audio to stream from the I/O or driver to the server and back. This determines the speed of real-time processing. Lower settings result in lower system latency and greater responsiveness. Higher settings yield more stability but greater latency. If you encounter pops or similar errors, increase the buffer setting. The buffer size is set in samples but is also displayed in milliseconds.
Colors	Range of colors	Adds a color strip on edge of server icon to ease identification of the device in the rack.



Menu Item/Indicator	Possibilities	Function
Information	Displays technical information about the server.	Use this information for troubleshooting and when speaking with Waves Technical Support concerning server issues.

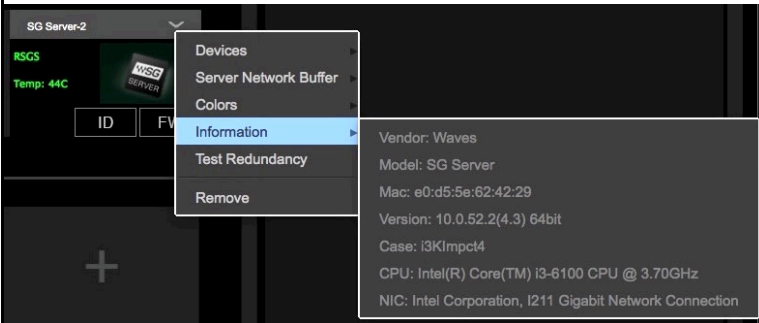

### Assigning Additional Servers

Assign a second server to provide redundancy in the event that the primary server fails. Switchover to the second server is automatic. Switchover time depends on the size of the session. During this period sound is muted. Redundant servers are labelled “RSGS” (Redundant SoundGrid Server).

Test Redundancy		<p>Test Redundancy runs your session through the main and redundant servers separately to confirm that each can handle the session without failure. If the redundant server cannot deliver the session’s processing needs, the session may not perform effectively if the main server fails.</p> <p>The result of this test is either pass or fail. If the redundant server passes, then all is well. If it fails, then you need to get a faster redundant server or reduce the number of plugins in the session.</p>
Remove		Releases the server from the local host. It will then be available to other hosts.



Indicators on the icon provide information about the server.

Indicator	Possibilities	Function
Online/Offline	Green or red	Online (green) or Offline (red)
Server Temperature	Degrees fahrenheit or celsius	Indicates the temperature of the CPU. Select temperature units in the Settings page.
CPU Meters	Primary server only	Average and Peak CPU values in numbers, and bars for each core (see below).
RSGS	Redundant server only	Identifies the second (redundant) server that will become the primary server in the event of a fault.

### CPU Meters

The meter bars on a server icon indicate CPU usage of each of the server's cores. There is one meter per core.



The solid bar areas display **average** DSP use per core. A yellow line shows **peak** DSP use per core. Both indicators are color-coded.

- Green      Less than 85% DSP load
- Yellow    85%–95% DSP load
- Red        Over 95% DSP load

A very high average indicates that the server is near capacity. You will likely need to remove some plugins.

Certain plugins can exhibit a high average/peak DSP ratio. This may cause overloads (momentary or constant) that result in audio drops. When adding a large number of these CPU-hungry plugins, the peak and average indicators will drift apart. If CPU is high, you may need to disable or remove certain plugins.



## Assigning Controllers

The Controllers slots at the bottom of the System Inventory page are used to assign up to five control devices. These devices can be used to control SuperRack functions. Click on a controller slot to open the drop-down menu and select a controller protocol. All installed controller drivers appear in the list, whether the device is present or not.

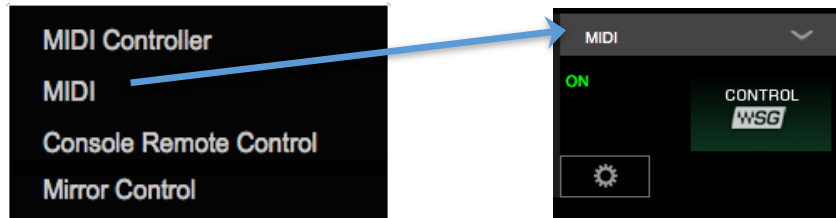

Controller device status is displayed on the device icon.

N/A: Device corresponding to selected protocol is not present or not functioning properly.

On: Device is present and operational.

Once a controller is selected and functioning properly, click on the Gear button to open its control panel. Using SuperRack with controllers is discussed in detail at the end of this user guide.



## Routing View Panel

The Routing View panel shows the status of network connections. Each row represents a one-way patch between two devices or between a device and the main server. Use the panel to isolate connection problems stemming from errors or too much traffic. If you're experiencing audio drops, or you see CPU overs in the Top Bar indicator, check here to troubleshoot the problem.

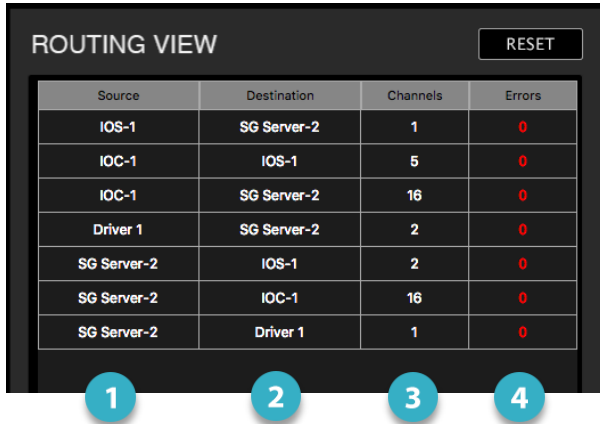

Source	Destination	Channels	Errors
IOS-1	SG Server-2	1	0
IOC-1	IOS-1	5	0
IOC-1	SG Server-2	16	0
Driver 1	SG Server-2	2	0
SG Server-2	IOS-1	2	0
SG Server-2	IOC-1	16	0
SG Server-2	Driver 1	1	0

In this example there are four network nodes:

- IOS-1 (I/O)
- IOC-1 (I/O)
- Host computer driver
- SG server 2

Note pairs of one-way connections between the host driver and the server, as well as the Device-to-Device connection between IOC-1 and IOS-2.

### Routing View Columns

- 1 SOURCE DEVICE**  
Origin of the network connection: I/O, server, driver.
- 2 DESTINATION DEVICE**  
Destination of the network connection: I/O, server, driver.
- 3 CHANNELS**  
Number of SoundGrid channels in the connection. A SoundGrid network channel reflects a one-way trip between a device and the server or between two devices. This includes patches made in the Device-to-Device page in the Patch window, something that is not evident in the Rack or Overview windows.
- 4 ERRORS**  
A count of the network packet errors on the connection. When an error occurs, the display flashes and the count is increased by one. Click Reset to clear the error count.



Use the Routing View Panel, in conjunction with the CPU and Memory indicators in the Top Bar, to diagnose problems or potential problems and determine where it likely originates. Some examples:

- A high CPU average load value means that the network line carrying the connection may be reaching its limit and dropouts might occur. Reduce the number of channels on this connection to reduce the network load.
- A low CPU load, combined with audio drops, on a connection from a server might indicate the server is causing the drops. If the server's peak CPU is high, reduce the server load.
- A low load and low SoundGrid server CPU might indicate a bad cable.
- Widespread drops can indicate that the switch may be faulty.

Note: Certain devices (e.g., IOS) incorporate a server and an I/O in one cabinet, but these components are completely independent of each other. You may choose to rename the server or I/O to avoid confusion.





# Settings Page

Use the Settings page to set overall system preferences and to assign user keys that can be recalled in the Rack and Overview windows.

The screenshot shows the 'Settings' page for 'Rack 1'. The interface is dark-themed with a top navigation bar containing 'OVERVIEW 1', 'OVERVIEW 2', 'RACK', 'PATCH', and 'SETUP'. The 'SETUP' tab is active. On the right, system status is shown: 'Session 16\*', 'BPM 120', 'TAP', 'SUPER RACK WSG', 'SERVER I/O/DAW', '48kHz AUDIO', 'REMOTE MIRROR', 'CPU MEM', and '15:36:44'. A 'Window' dropdown is also present.

The main settings area is divided into several sections, each with a numbered callout:

- 1 CONFIGURATION:** Selects the number of racks (4, 8, 16, 32, 64). '64 RACKS' is selected.
- 2 STARTUP SESSION:** Selects the session to start (PREVIOUS SESSION, LAST STATE, EMPTY SESSION). 'PREVIOUS SESSION' is selected.
- 3 APPLICATION RECOVERY:** Selects recovery mode (MANUAL, AUTOMATIC). 'MANUAL' is selected.
- 4 LOCK:** Toggles 'PLUGINS', 'SNAPSHOTS', 'REMOTE', 'GUI', 'ROUTING', and 'PASSWORD'. 'PLUGINS' is checked.
- 5 METER CLIP:** Sets 'CLIP THRESHOLD' (0) and 'CLIP HOLD' (2).
- 6 PLUGINS:** 'UPDATE PLUGINS LIST' button with 'SCAN' sub-button.
- 7 A/B INPUTS & OUTPUTS:** 'ALIGN OUTPUTS TO INPUTS' checkbox.
- 8 TEMPERATURE UNITS:** Selects 'CELSIUS' or 'FARENHEIT'. 'CELSIUS' is selected.
- 9 HISTORY:** 'AUTO SAVE EVERY' (3) MINUTES, 'ON SNAPSHOT UPDATE' checkbox, and 'SAVE HISTORY FILES TO:' field with 'BROWSE' button.
- 10 LATENCY GROUP SETTINGS:** 'ALIGN ALL RACKS AUTOMATICALLY' checkbox and 'ALIGN BY LATENCY GROUPS' checkbox (selected).
- 11 TROUBLESHOOTING:** 'WARN BEFORE DELETING SNAPSHOT', 'SHOW PATCH WARNINGS', and 'ENABLE LOGGING' checkboxes.
- 12 USER KEY ASSIGNMENTS:** A list of 16 user keys with dropdown menus for their actions. 'None' is selected for key 12. 'IMPORT', 'EXPORT', and 'CLEAR ALL' buttons are at the bottom.



## SETTINGS PAGE SECTIONS

### 1 SuperRack Configuration

Sets the number of racks in the session. Limiting the number of racks in a session to no more than needed makes for a cleaner display.

Configuration is normally established when a session is created, but you can change the number of racks in an existing session. However, if you reduce the number of racks in a session, the settings in racks that are no longer part of the session will be discarded. Save a session under a revised name before you reduce its size.

Range: 4, 8, 16, 32, 64 racks

### 2 Startup Session

Determines the startup condition of the mixer:

<b>Previous Session</b>	Loads the most recent session to the last user save.
<b>Last State</b>	Loads the most recent session to its last state before quitting.
<b>Empty Session</b>	Mixer opens with a blank session.

### 3 Application Recovery

In the event that that the SuperRack application crashes, it will re-launch automatically. Relinking between the host and the server causes a brief mute. SuperRack lets you choose how this relinking will happen:

**Automatic** means that the application launches and connects to the server automatically.

**Manual** means the application launches with the session but waits for you to press the **Connect** button to connect to the server. This provides control over when the relinking mute will occur.

### 4 Lock

Determines what controls cannot be altered when the Lock button in the top bar is engaged. Any combination of these controls can be locked: routing, plugins, remote, and snapshots. In addition, the entire interface (GUI) can be locked. All selections can be protected with a password.



## 5 Meter Clip Settings

Clip Threshold determines the level at which the clip light turns red. When Clip Threshold is set below 0 dBFS, a warning appears before clipping actually occurs.

Range: 0 dBFS to -18 dBFS,

Clip Hold: 0 seconds–5 seconds

## 6 Plugins

Rescans the plugins folder. This is useful, for example, if you download a demo plugin and you don't want to restart SuperRack. Use this as well when you configure a session offline.

## 7 A/B Inputs & Outputs (Link A/B Inputs and Outputs)

Each rack has inputs A and B, and outputs A and B. Linking between them means that switching from input A to input B will switch the outputs correspondingly. When not selected, inputs and outputs act independently of each other.

## 8 Temperature Units

Selects unit for display of server CPU temperature. Range: Celsius or Fahrenheit.

## 9 History

Establishes preferences for auto-saving.

**Autosave Every xx Minutes:** Makes a complete copy the current SuperRack condition at defined intervals

Range: 3 minutes–30 minutes

**On Snapshot Update:** Auto-save each time a snapshot is stored, recalled, or modified.

**Save History Files To:** Each time SuperRack does an auto-save, a new History file is created. Auto-saved files are not deleted; new saves do not replace old saves. SuperRack provides a default location for history files:

Mac: Users/Shared/Waves Audio/SuperRack SoundGrid/history

Windows: Users\Public\Waves\SuperRack\history

Use the Browse button to select a new location. This path is saved in the session preferences.



User-saved session files are saved in the adjacent Sessions folder. Delete history files and session files using the host computer, not the SuperRack application.

## 10 Latency Group Settings

### Align All Racks Automatically:

All racks are time-aligned to one delay value, which can be the main output of the mixing desk or another buss. The rack with the greatest latency sets the latency for the entire session. In this mode, individual latency groups cannot be delayed.

### Align by Latency Group

Racks are members of up to 16 latency groups, which are used to align select groups. Any latency group can address latency correction in one of two ways.

LATENCY GROUPS				SETTINGS				1	2	3	4	5	6	7	8
ON/OFF	Latency Group	Auto/Manual	Latency Value	Unit	Rack 1	Rack 2	Rack 3	Rack 4	Rack 5	Rack 6	Rack 7	Rack 8			
ON	Latency Group 1	Auto	0.0	Samples	■						■				
ON	Latency Group 2	Manual		Milliseconds				■							
OFF	Latency Group 3	Manual		Feet			■								
ON	Latency Group 4	Auto		Meters		■									
	Latency Group 5			Meters											■

**Auto mode** calculates latency compensation dynamically. Rack latency adjusts to match the delay of the plugin in the group with the highest latency.

**Manual mode** lets you set a specific delay for the group. Latency will never go above or below the specified value. You cannot insert a plugin that will result in the latency value being exceeded.

Latency Group Auto/Manual selection and latency values are set in the Patch window.

## Speed of Sound

User-determined speed of sound measurement for use in delay-related calculations. Display is in meters/second. Default: 340 meters/second

## 11 Troubleshooting

### Warn Before Deleting Snapshots

Presents a prompt before deleting any snapshot.



## Show Patch Warnings

Displays a warning when attempting to change a patch.

## Enable Logging

Creates a troubleshooting log that is placed on the desktop. This log is useful when communicating with Waves technical support.

## 12 User Keys



In the Overview windows and the Rack window, there is a panel with 16 programmable buttons that can be assigned to important or often-used commands. This, among other things, lets you issue commands that are in a different window, without leaving your current view. It also lets you immediately access certain menu items that are deep inside multi-level, drop-down menus.

The User Keys panel can be torn off and floated to any location on the display. Click the arrow in the top left corner of the panel to tear it off and to reattach it.

Refer to the [Floating Panels](#) section for details.



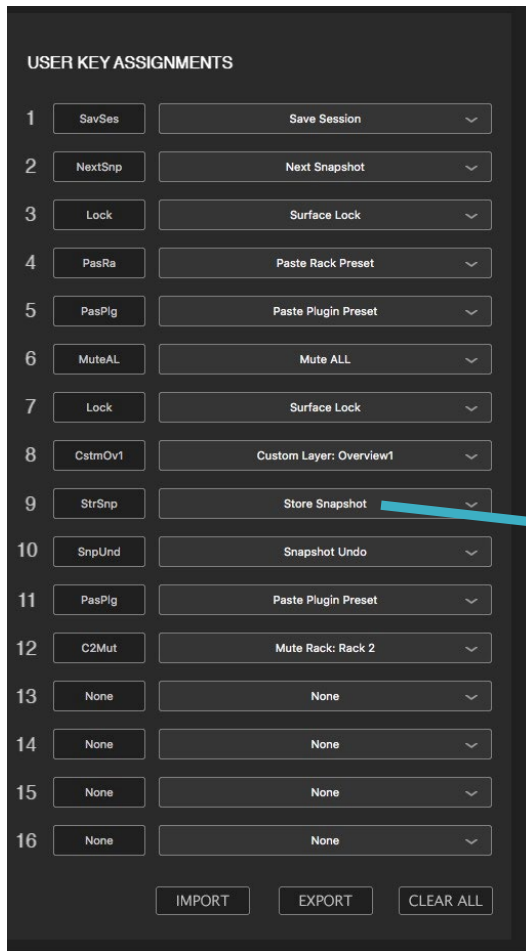

User Keys are assigned in the panel on the right side of the Settings page.

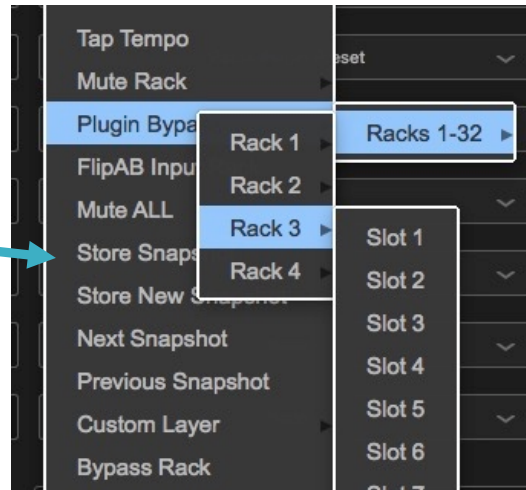

Select one of the 16 buttons, open the drop-down menu, and choose a function or command.

Use the buttons at the bottom of the panel to import and export user-assignable keys. Clear All removes all User Key assignments.

User Keys are recalled from the panel on the right side of the Rack and Overview windows. This panel can be detached and moved to any location on those windows. User-assignable keys can also, by default, be recalled with keyboard Function Keys.



## Part 4: Patch Window

The Rack Window is a grid that's used for patching between assigned I/O devices on the SoundGrid network. It also provides a quick way to assign racks to link groups and latency groups, and to get an overview of all group assignments.

Patching is the same for each kind of connection—only the frame around the Patching Grid changes to match the nature of the assignment. Making a patch involves three steps.

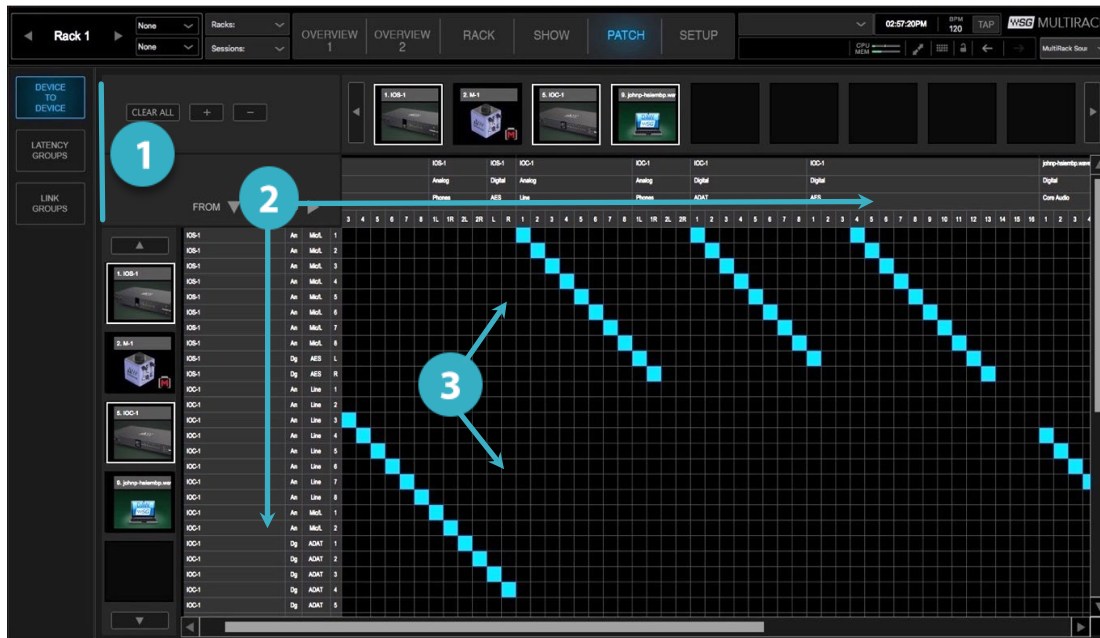

**PATCH VIEWS:** What kind of patch do you want to make? This choice establishes the patching framework.

**PATCHING FRAMEWORK:** These are the device channels or groups that can be patched based on the selected Patch View.

**PATCHING GRID:** The specific patch points between devices or groups.

### 1 Patch Views

The Patch Views selector is on the left side of the window. Selecting a Patch View determines the *category* of patch. This establishes the framework of the patch grid and sets the possibilities of what can be patched to what.



There three Patch Views:



### Device-to-Device Patching

Patches between assigned I/O devices in the SoundGrid network.

### Latency Groups

Assigns racks to latency groups. It provides an overview of all assignments and allows you to make latency group assignments to several racks at once.

### Link Groups

Assigns racks to link groups. It provides an overview of all assignments and allows you to make link group assignments to several racks at once.

## 2 Patching Frameworks

When you select a Patching View, the frame around the Patch Grid changes to provide the connections necessary for the type of patch selected. The Patching Framework displays the specific I/O devices and their channels, racks, link groups, or delay groups.

### 1-Device-to-Device

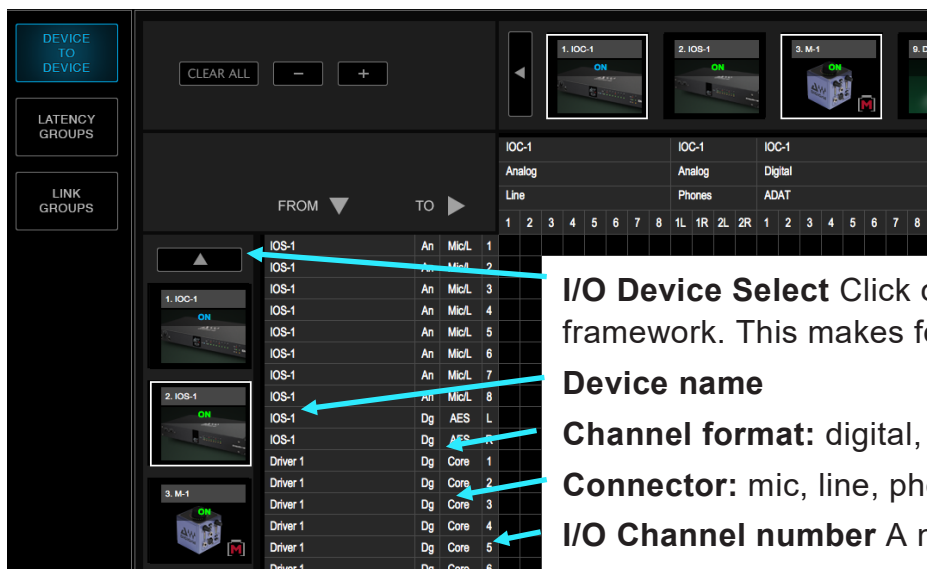

The Device-to-Device frame displays the same I/O device information on both axes.

**I/O Device Select** Click on a device icon to display or hide its channels on the framework. This makes for a tidier patch view.

**Device name**

**Channel format:** digital, analog

**Connector:** mic, line, phones, AES, S/DIF, ADAT, Core Audio, etc.

**I/O Channel number** A number indicates a mono channel; L or R indicates stereo.





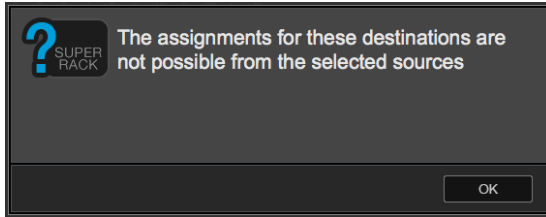

We suggest that you hide the devices that you will not be patching to or from. This cleans up the window and prevents you from trying to patch a device to itself.

Device-to-Device patching connects devices: it is not used to patch audio to and from a rack. Audio routing to and from the racks is carried out in the [Rack Window](#) and Overview Window.



If you're using a large number of I/O devices, the list of device icons may spread beyond the frame. Use the arrow buttons to scroll the device list left and right or up and down.

## 2–Latency Groups

Use the Latency Groups framework to assign racks to latency groups, define the group's behavior, and assign delay values per rack. Latency is discussed in the next section, [Managing Latency in SuperRack](#).



### 3–Link Groups

When racks are linked, the identical controls of all members of the group move together. Variable controls are linked relatively. If controls are set to different values before they are linked, they will move together, and their offsets will be preserved.

Controls that are linked:

- A/B input and output selection
- Input and output gain
- Plugin In/Out
- Mute

Plugin controls are not linked.

There are 16 link groups. Any link group can include up to 64 racks, depending on the size of the session, but a single rack can be a member of only one link group. The Patch window is an easy way to assign racks to link groups and to gain an overview of all link patches in the session.

	1	2	3	4	5	6	7	8	9	10	11	12	13	14	15	16	17	18
	Rack 1	Rack 2	Rack 3	Rack 4	Rack 5	Rack 6	Rack 7	Rack 8	Rack 9	Rack 10	Rack 11	Rack 12	Rack 13	Rack 14	Rack 15	Rack 16	Rack 17	Rack 18

LINK GROUPS
ON Link 1
ON Link 2
ON Link 3
ON Link 4
ON Link 5
ON Link 6
ON Link 7
ON Link 8
ON Link 9
ON Link 10
ON Link 11
ON Link 12
ON Link 13

**1 Rack Number**

**2 Rack Name**

**3 Link Group On/Off** Suspends the link group.

**4 Link Group Name** Double click to rename.

You can also use the Link Groups Assignment drop-down menu to assign the selected rack to one of sixteen link groups.



### 3 Patch Grid

This is where patches are made between devices and racks are assigned to latency groups and link groups. All patches follow the same conventions.

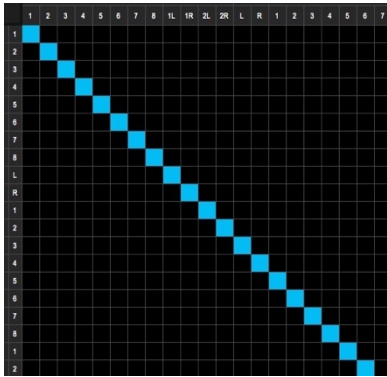

- To create or remove one patch → Click on a patch point
- To create a straight line of patches → Drag vertically, horizontally, or diagonally
- To create noncontiguous patches → Hold Cmd (Mac) or Ctrl (PC) and click on the patch points

#### OTHER PATCH CONTROLS

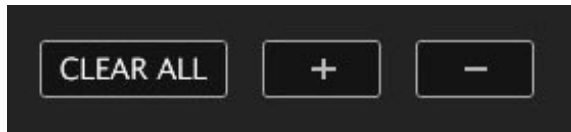

Click Clear All to remove all patches in a view. This cannot be undone.

Click the + and – buttons to zoom in and out of the Patch Grid.

Use the scrollbars at the bottom and right sides to move beyond the visible image.



## Managing Latency in SuperRack

Latency is the delay imposed by the rack's processing chain. Plugin processing is the most common cause of latency. Many plugins have zero latency, others a moderate amount, and some have a great deal. These signals must be time-aligned at the rack's output, otherwise the signals will be out of sync with each other.

Use the Latency Groups framework in the Patch window to assign racks to latency groups, define the group's behavior, and assign delay values per rack. You can also assign a rack to a latency group in the Top Bar.

LATENCY GROUPS					SETTINGS																				
ON/OFF	Latency Group Name	Assignment Mode	Latency Value	Delay Calculation Unit	1	2	3	4	5	6	7	8	9	10	11	12	13	14	15	16	17	18	19	20	21
ON	Latency Group 1	Auto	0.0	Samples																					
ON	Latency Group 2	Auto	0.0	Samples																					
OFF	Latency Group 3	Manual	0.0	Feet																					
ON	Latency Group 4	Auto	12.0	Meters																					
OFF	Latency Group 5	Manual	240.0	Feet																					
OFF	Latency Group 6	Auto	12.0	Meters																					
ON	Latency Group 7	Auto	126.0	Samples																					
OFF	Latency Group 8	Auto	7.0	Milliseconds																					
ON	Latency Group 9	Auto	42.0	Milliseconds																					
ON	Latency Group 10	Manual	90.0	Samples																					
OFF	Latency Group 11	Auto	120.0	Samples																					
OFF	Latency Group 12	Auto	96.0	Samples																					
OFF	Latency Group 13	Auto	12.0	Samples																					
ON	Latency Group 14	Manual	16.0	Meters																					
OFF	Latency Group 15	Auto	4.0	Milliseconds																					
OFF	Latency Group 16	Manual	19.0	Feet																					

- 1 RACK NUMBER
- 2 RACK NAME
- 3 LATENCY GROUP ON/OFF  
Turning off a latency group suspends it from latency compensation calculations.
- 4 LATENCY GROUP NAME  
Double-click to rename the group
- 5 ASSIGNMENT MODE  
**Auto:** Group latency group is calculated automatically. It varies depending on the latency of plugins in the group.  
**Manual:** In this mode, you can assign a latency value to the latency group.

### 6 LATENCY GROUP VALUE

In the Manual Assignment mode, this setting provides a fixed group latency. Group latency will never be less or more than this value. This value box is disabled in the Auto Assignment Mode.

### 7 DELAY CALCULATION UNIT

Unit of measurement used for displaying the delay of a latency group. This selection does not affect the value, only the display. The delay value can be entered in samples, milliseconds, feet, or meters.



## Latency Compensation

Latency compensation assures that signals are time-aligned, regardless of how they are processed or routed. Depending on settings, SuperRack can compensate for latency differences in three different ways:

- Align the plugins within a rack
- Align the racks in a latency group
- Align every rack and plugin to one delay group

### ALIGNING PLUGINS IN A RACK

The diagram below illustrates one rack with three plugins. Each plugin has a different latency, so the plugins are not time-aligned in the rack. Latency compensation delays the plugins with the least latencies (in this case, plugin #2 and plugin #3) to match the plugin with the greatest latency (plugin #1). In this example, plugin #2 was delayed by an additional 55 samples and plugin #3 an additional 97 samples. The three plugins in the rack are now aligned with each other. The rack reports a latency of 100 samples.

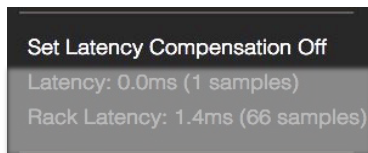
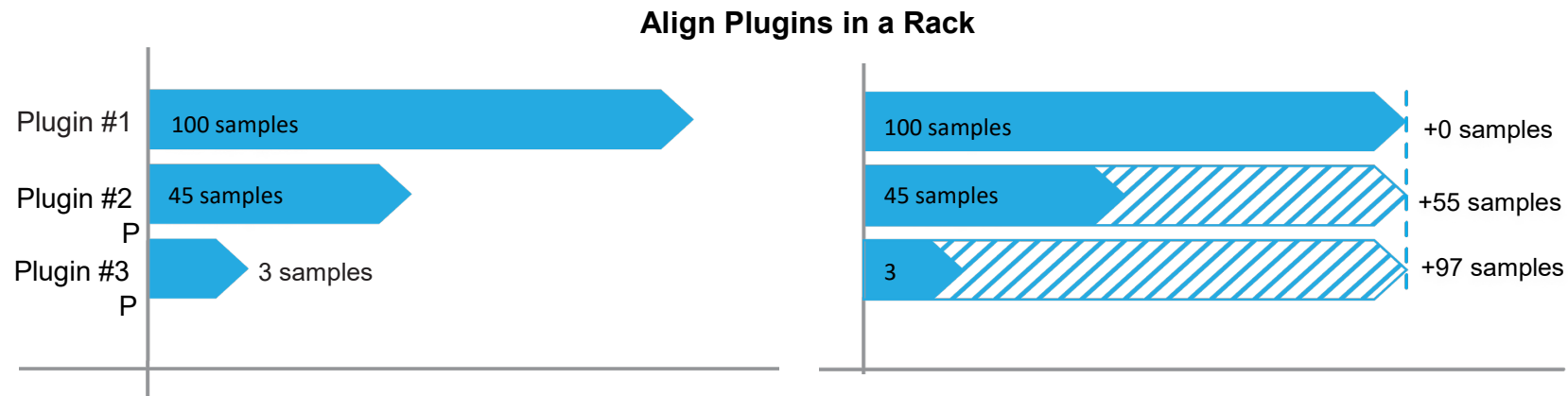

You can remove individual plugins from the rack's latency compensation calculations. This is done in the plugin's drop-down menu. Turning off a plugin's latency compensation does not affect its actual latency: it merely takes it out of latency calculations. If, in the example above, plugin #1 is removed from latency compensation, the rack will report a latency of only 45 samples. Plugin #1 will still have a latency of 100 samples, but it will not affect the latencies of the other plugins in the rack.



## Latency Groups

A latency group is a collection of racks whose delays are controlled together, whether for latency compensation or group delay. Assign racks to latency groups using the Latency Groups drop-down menu in the Top Bar or the Patch Window, Latency Group page.

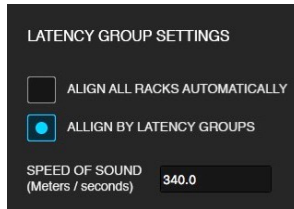

Plugins and racks can be aligned to one common latency or assigned to latency groups. This is selected in the Settings page.

**Align all Racks Together** Latency compensation is calculated across the entire session; all racks are time-aligned together. Latency for the entire session is calculated based on the rack with the greatest latency.

**Align by Latency Groups** Several racks can be combined to form up to 16 latency groups. All of the racks in a latency group are time aligned with each other, so that when their signals return to the sound card or interface, they are all in sync. There are, in addition, two modes within the Align by Latency Groups setting. Latency groups can be delayed so that racks can be sent to specific I/Os and their delays controlled.

Align by Latency Groups offers two modes for managing each latency group. Choose between these modes in the Patch window (Patch>Latency Groups).

**Auto mode** calculates latency compensation dynamically. Rack latency adjusts to match the delay of the plugin in the group with the highest latency.

**Manual mode** lets you set a specific delay for the group. Latency will never go above or below the specified value. You cannot insert a plugin if it will result in this latency value being exceeded. To manually set a group's latency value, toggle the Auto/Manual button to Manual. Double-click on the value box to enter a number.



## Latency Group Alignment

In the earlier example, three *plugins* in a rack were time aligned so that all were in sync at the rack output. In the following example, three *racks* are assigned to a latency group. All of the racks are latency corrected internally, but each rack has its own latency, so they must be time aligned.

This latency group consists to three racks. Rack #1 has a latency of 100 samples. This is the rack that we aligned in the previous example. Rack #13 and Rack #27 have lower latencies.

### Align Racks in a Latency Group

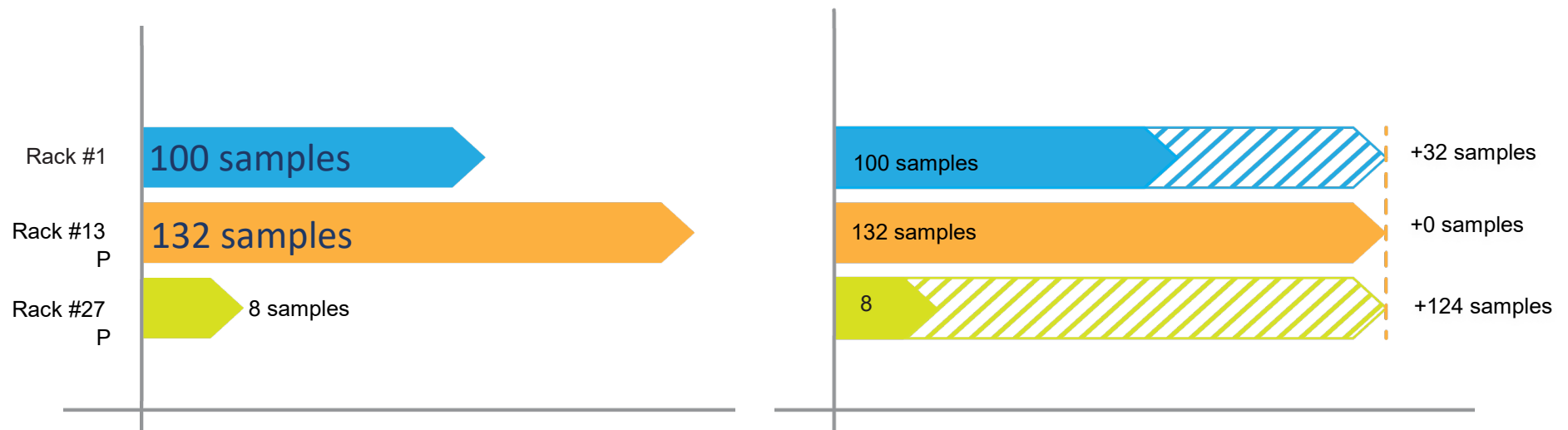

Delay was added to Rack #1 and Rack #27 to align with rack #13, the rack with the greatest latency. The resulting Latency Group delay is 132 samples.



## Part 5: Rack Window

The Rack window is used to control all the settings of a rack. It presents the complete interface of any plugin in the rack (up to eight altogether). This enables convenient assignment of input and output I/Os; and it provides for rearranging plugin sequence in a rack, thus altering processing signal flow.

There's a lot of overlap between the Rack window and the Overview windows, but they are used differently. The Overview windows show a condensed view of an *entire layer* of racks so that you can quickly interpret and manage several racks at once. The Rack window, on the other hand, presents you with everything you need to set up and control *one* rack. Use it to set every detail of a rack

The window is divided into four sections.



- 1 Input Section**  
Select input set A or B, assign I/O channels, and adjust input level. Rack input format is established here.
- 2 Plugins Rack**  
Add up to eight plugins and external inserts. Control latency compensation and recall safe.
- 3 Plugin Pane**  
The complete plugin interface.
- 4 Output section**  
Control rack output routing to I/Os; Control output gain.





## Selecting a Rack

The Rack window is all about controlling a specific selected rack, so you need to be able to get to it quickly. There are three ways to do this:

- Use the Racks drop-down menu to navigate directly to a Rack (Top Bar).
- Use the arrows next to the Rack Name box to move up and down the rack, one rack at a time (Top Bar).
- Select a rack in the Overview window. Touch the plugin icon to open the complete interface.

## Rack Input Section

The Input Strip on the left side of the interface is used to select inputs, choose I/O devices, control input gain, and bypass the rack.

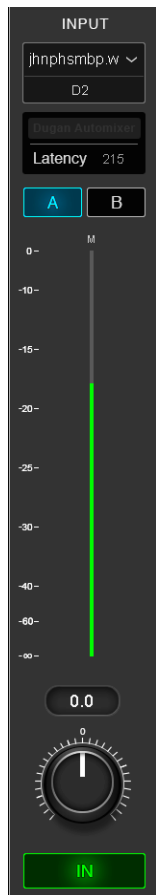

**Input I/O source:** choose from any assigned I/O device, anywhere on the SoundGrid system.

**Latency Value Box:** shows the total latency of the rack.

**Input Set Select:** lets you select between two input sets, A and B. This is useful, for example, in a situation where two mixers share the same SuperRack, or when different songs use different channels on the main consoles (e.g., singer has moved to another mic). It is also a convenient way to switch between a virtual soundcheck and the show.

The full-scale **Input Meter** displays post-input-trim gain. The number of meter bars reflects the format of the input I/O device. The meter turns red when the input level is clipping. Adjust clip threshold in the Settings page.

The **Input Gain Knob** controls the rack input level. The position of the input knob is shown in the value box. Range: -18 dB to +18 dB.

The **In** button bypasses the rack's plugin processing. The rack still passes audio. Green: rack on; Gray: rack off.



## ASSIGNING RACK INPUTS

Rack input is assigned at the top of the rack. The number and format of I/O device channels routed to the rack determines its configuration and define which plugins can be used.

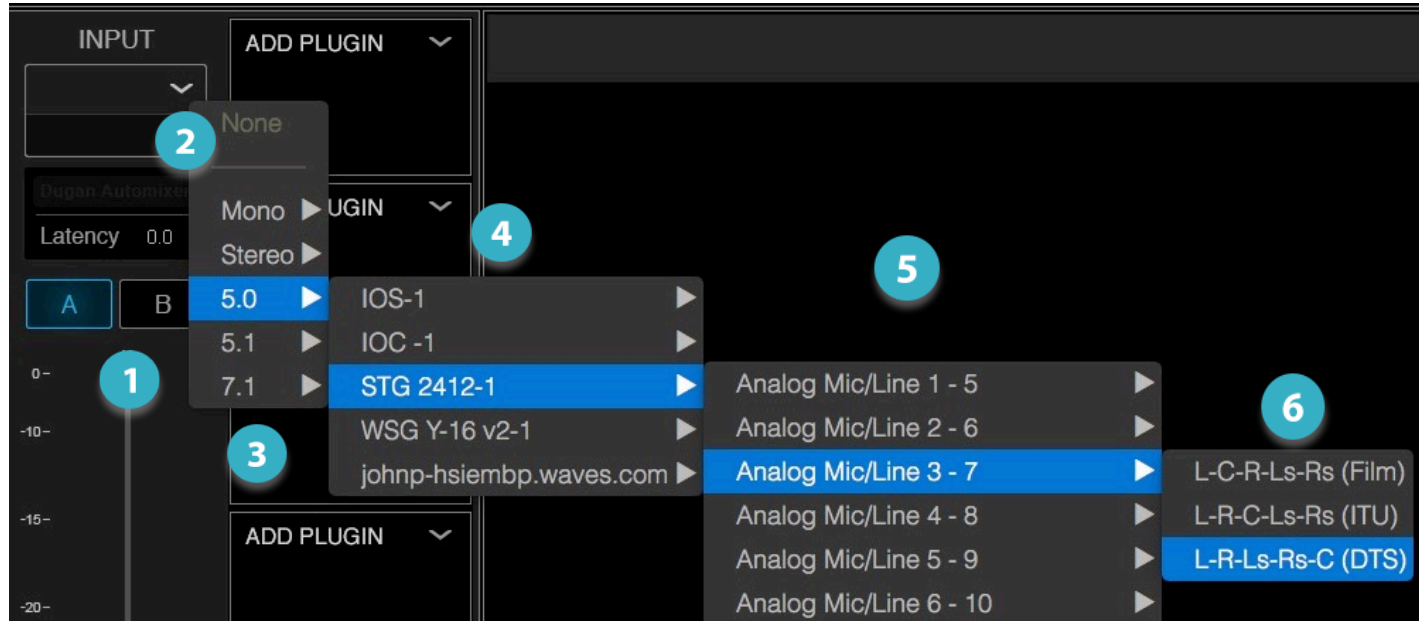

To assign I/O device channels to a rack:

- 1 Use the **Input A/B Select** button to choose between the two input sets for each rack. Inputs A and B can patch to different device channels, but they must have the same channel formats.
- 2 Click on the down arrow to open the drop-down **Input Menu**.
- 3 Select the input format (e.g., mono, stereo, 5.1, 7.1). This sets the number of device I/O channels patched to the rack input and establishes the format of the rack. Some plugins do not have components for all rack channeler formats. Test your plugins with the formats you want to use before you configure lots of tracks. If the plugin does not have a component with the desired format, select another track format or choose another plugin to resolve the problem.
- 4 Choose an I/O device. Only devices that can provide the requested number of I/O channels are listed.



- 5 Select the range of I/O device channels for the input patch.
- 6 Set the channel format (L-C-R-S, L-CL-C-CR-LS-RS-LFE, etc.). This defines how channels are arranged in the stream. For example, the 5.0 channel stream as shown above can be formatted as L-C-R-Ls-Rs, L-R-C-Ls-Rs, or L-R-Ls-Rs-C. This sequence is displayed at the top of the meter.

Rack input and output do not need to be the same format, but they must be compatible. Some plugins do not have components for all rack formats, so check to see if the plugin has the component you want before committing to a rack format. If you attempt to patch a device channel that is patched elsewhere, you will be prompted. You can accept the new configuration (which will remove the current patches) or select Cancel and try patching to different I/O channels.

The input is now set, as is the structure of the rack. You can later change the number of input channels in the rack, but this will disable plugins that do not have components that support the new channel configuration and may alter the output format.

## Rack Output Section

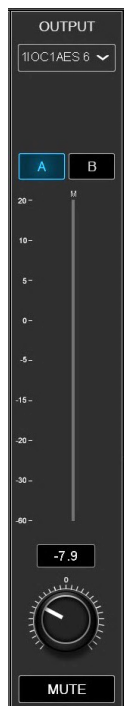

The output section controls rack output level and assigns I/O devices to the rack output.

### I/O Channel Select

Choose from any assigned I/O device, anywhere on the SoundGrid network.

### Output A/B

A rack output can be patched to two separate I/O devices. This is useful, for example, in a festival environment where there are two console sets and you need to quickly switch from one to the other. Device I/O patching must be identical for both rack output sets.

### Output Meter

Full-scale output meters. The number of meter bars reflects the format of the output I/O (e.g., stereo, 5.1, 7.0, etc.); range: -INF to 0 dBFS

Adjustable peak and clip indicators. Peak and clip behavior set in the Settings menu. Click on the meter to clear indicators manually.

**Rack Output Control:** Range: -18 dB to +18 dB



**Mute:** mutes the rack.

## ASSIGNING RACK OUTPUTS

Rack outputs are assigned in the same manner as rack inputs. A single rack output can patch to several device I/Os.



Repeat this procedure for all I/O channels. Rack input and output do not need to be the same format, but they must be compatible. Many plugins do not have components for all rack formats, so test plugin compatibility before committing to a rack format.

- 1 Open the Output Device drop-down menu.
- 2 Select an output format. Choosing an output format incompatible with the input will change the input to a format compatible with the new output format setting.
- 3 Select a device. The I/O channel that is currently patched to this rack is shown at the top of the menu there. Click on this name to open the control panel for this device.
- 4 Select the output device I/O channels. If you select device channels that are already patched to another rack, you will be prompted to change the routing or cancel the rerouting.
- 5 Set the channel format (e.g., L-C-R-S, L-CL-C-CR-LS-RS-LFE, etc.) if applicable.



## *Routing Racks Automatically*

SuperRack can automatically route input and output I/O channels to each rack in a session. Routing begins at the first rack, which will be patched to the first available I/O device channel. Patching continues until all racks in the session are routed or all I/O channels have been assigned.

If a SuperRack system has more than one I/O device assigned, the order of the devices in the Inventory determines the sequence in which I/O channels will patch to the racks. When the first I/O has routed all of its channels, patching continues with the next device.

I/O channels are patched into existing rack configurations, so you need to set the number of input and output channels before you start the auto-route routine.

1. Select a SuperRack template that loads the desired framework, void of patches—just the rack structure. If you don't have a template that matches your needs, follow these steps to create an auto-route template:
  - a. Create a session with the desired rack input/output configuration and number of tracks. If your hardware I/O devices are not assigned in your SuperRack Inventory, use offline devices to build a framework. Make sure that your plugins have components that will support a rack's configuration.
  - b. Once you've routed I/O channels to provide the framework you want, select "None" in the input and output drop-down menus.
  - c. Save the session as a template.
  - d. Load the template.
2. Click Auto Route to patch the session automatically.

If you want to create a blank session in which all racks are mono-in and mono-out, select "New" in the Sessions page of the Show window.



## Inserting a Plugin

1. Click the arrow on a rack slot to open the Plugins menu. Use this menu to add, remove, and manage plugins.
2. Choose a plugin from the Plugin List; its icon will appear in the slot. The list of available plugins is organized by category. Long category lists are divided into groups of about 20 plugins.

The format of the Input I/O device sets the input format of the rack, and hence the plugins that you can use. If, for example, the format of the Input I/O is 5.1, then only the plugins that support this channel input format will be displayed in the plugins list.

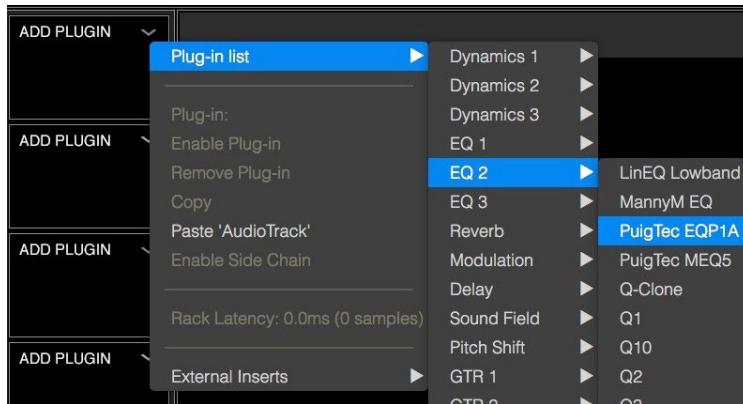

If you change the rack's input format while plugins are installed in the chainer, the plugins will seek a way to remain active. If the plugin has a component that can suit the new rack format, that component will load.

If an appropriate component is not available, the plugin will be disabled.

**Note:** Adding, removing, disabling, or moving a plugin changes the structure of the rack, which can result in a brief audio mute. Do not make these changes when an audio interruption is unacceptable. Wait until there is a pause in the performance. Bypassing a plugin or changing its parameters can be done at any time.



## Plugins Chainer

You can insert plugins in any slot, in any order. Plugin chainer signal flow is from top to bottom, so plugin sequence determines processing order. Drag a plugin up or down the rack to change its place in the signal flow. Plugin status is indicated directly on the plugin and on the rack slot frame, as shown here:



1	Plugin Name	Name is abbreviated if necessary.
2	Plugin Icon	Displays thumbnail of plugin interface. Click on the icon to open the plugin.
3	Open Plugin Menu	Use the menu to access all plugin management items.
4	Plugin Latency Indicator	Displays plugin latency. Total rack latency is displayed above the input meter.
5	Plugin Output Meter	Includes clipping indicator. Number of meters indicates the number of rack output channels.
6	Sidechain Enabled	Indicates that the plugin is receiving a sidechain signal and its sidechain is active.
7	Plugin Recall Safe	The plugin is in a snapshot-safe mode.
8	Mono-to-Stereo Plugin	Inserting a plugin that has a different number of inputs than outputs changes the channel format on all subsequent plugins (see next page).
9	Plugin In/Out	Turns the plugin on or off. It does not remove it from the processing chain.
10	Hot Plugin is Assigned	Indicates that the plugin has been assigned to a hot plugin position.
11	External Insert	Provides up to 32 insert points for external processors.
12	Disabled Plugin	Plugin is removed from CPU. Plugin settings are restored when the plugin is reenabled.
13	Empty Plugin Slot	Click on the down arrow to assign a plugin to the slot.



## Plugins Can Change the Rack Size

While it's true that the number of channels in a rack is defined by its input, certain plugins increase the channel count of the chainer. In a rack that is configured as stereo, stereo plugins will be used to populate the chainer—simple. Certain plugins, however, allow you to increase or decrease the number of rack channels. The most common examples are mono-to-stereo reverb plugins, but there are also larger-format up-mixing and down-mixing plugins. In the example below, a stereo-to-5.1 plugin is inserted in the middle of the chainer. All plugins earlier in the signal flow (above) will remain stereo. Plugins later in the chain are 5.1, and the rack output is in one of the 5.1 formats.

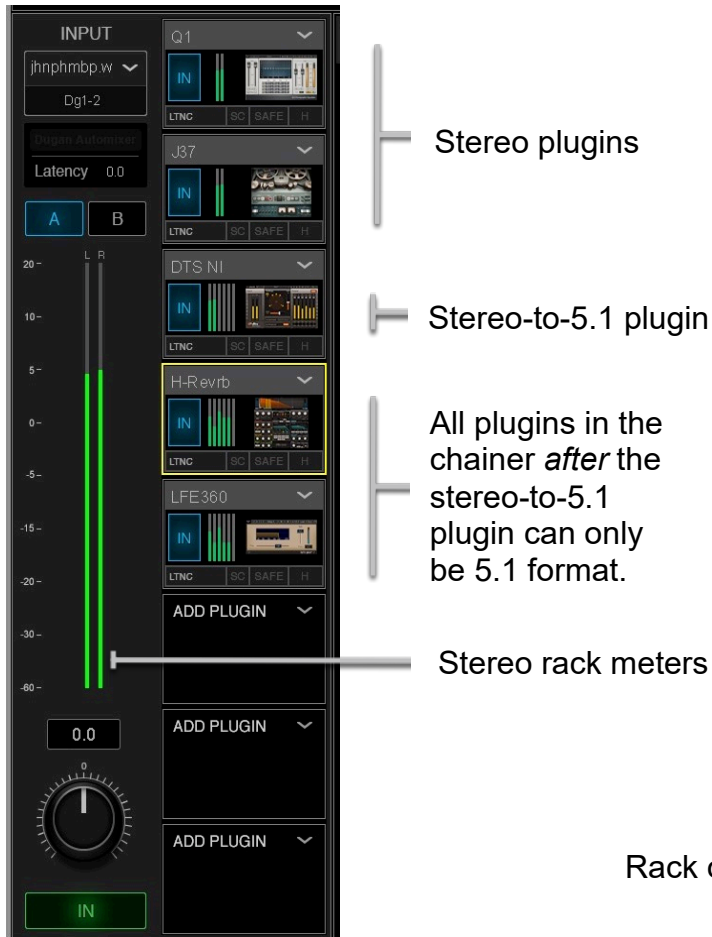

Moving an up-mixing or down-mixing plugin up or down the chain will affect the plugins that are inserted after it. If, for example, you move a stereo-to-5.1 plugin to a slot above an existing stereo plugin, the stereo plugin will become disabled.

Rack output is 5.1.

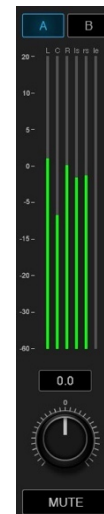



## Plugin Pane

Click on a plugin icon to open its plugin pane. This view shows a plugin's entire user interface, from which you can control all plugin settings.



## Managing Plugins

### The Plugin Menu

The **Plugin** menu is used to insert, remove, assign, and manage a selected plugin. It is also used to copy plugins and plugin settings between racks and between rack slots. Plugin menu settings affect only the selected plugin slot. To manage presets for an entire rack, use the **Racks** menu in the Top Bar. Refer to [Part 2: The Top Bar](#).

The Plugin menu is accessed with the arrow at the top of a rack slot.

### BASIC PLUGIN MENU

If a plugin slot is empty, the Plugin menu looks like this. It's used for four things:

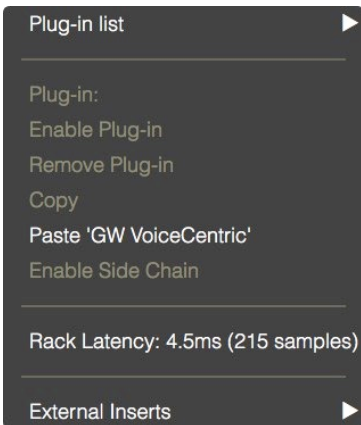
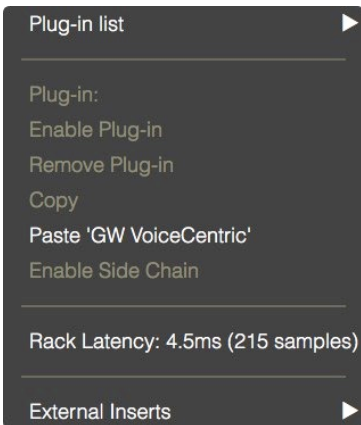
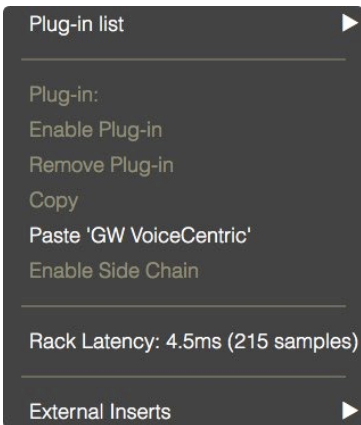
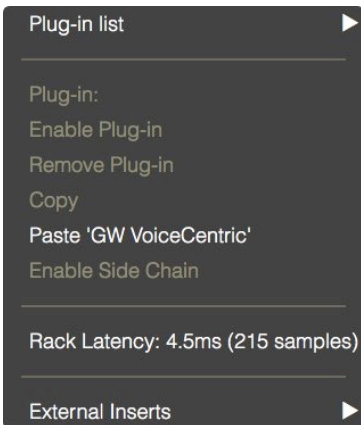
	▶ Insert a plugin from the Plugin List
	Paste a copied plugin and its preset
	Learn current latency for the entire rack
	▶ Add external inserts to the rack

All other menu items are grayed out.

### PLUGIN LIST

The Plugin List is a drop-down menu that lists all available plugins. Only plugins that have components compatible with the current rack format are displayed. If, for example, the rack is 5.0 channels, you will not be given the choice of loading a Q10 or WNS or similar plugins, since they do not have 5.0 components.



## PASTE [PLUGIN NAME]

Pastes a copied plugin and its settings to an empty slot or replaces the plugin that occupies the slot. In certain circumstances it is possible to paste a preset into an existing plugin (see *Paste [plugin name] Preset* below).

## RACK LATENCY

Indicates the total latency of all plugins and external inserts in the rack. If no latency is declared, the text is grayed out.

## EXTERNAL INSERT

Add external inserts to a plugin rack.

## EXPANDED PLUGIN MENU

Once a plugin has been inserted in a rack slot, an expanded menu replaces the basic menu.

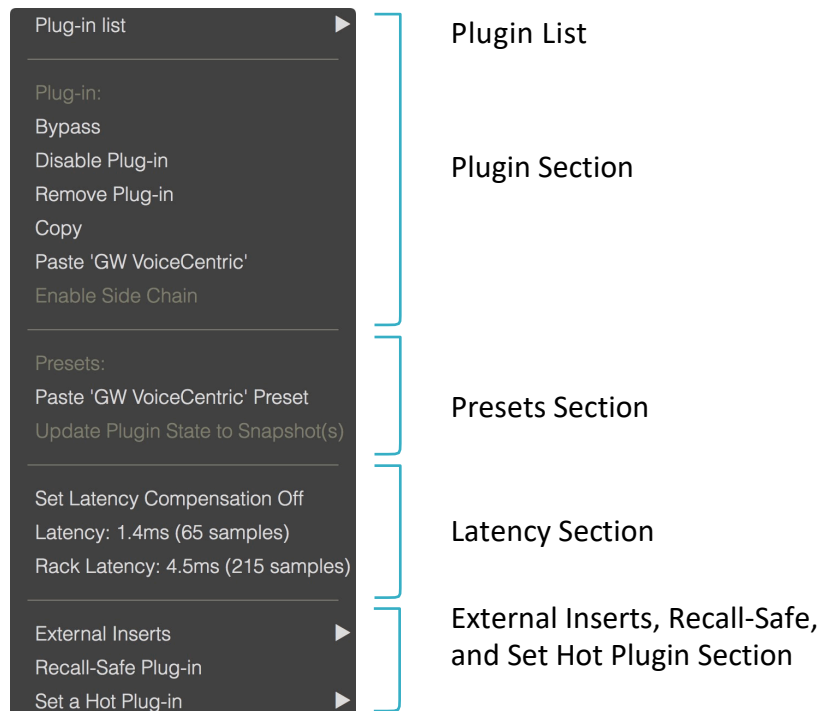

## Plugin Section

### **BYPASS**

Bypasses the plugin while keeping it in the processing chain. This serves the same function as the IN button on the rack slot.

### **ENABLE/DISABLE PLUGIN**

Removes the plugin from the processing chain without deleting it from the rack. Disabling a plugin removes its latency from the rack. It also frees up processing power. You can re-enable the plugin without losing its settings, controls, or automation assignments. When a plugin is disabled, its name will remain visible above the slot and its icon will be replaced with DISABLED. You can also disable and enable a plugin by clicking its rack slot while holding down the Ctrl key.

### **REMOVE PLUGIN**

Deletes the plugin from the rack slot. All settings and control assignments are lost. You can also remove a plugin by dragging it off the plugin pane.

### **COPY**

Copies the plugin and its settings. This enables pasting the plugin and its current settings to another rack slot. There are two paste options: Paste [plugin name] and Paste [plugin name] Preset.

### **PASTE [PLUGIN NAME]**

Pastes the copied plugin and its settings to an empty slot or replaces the plugin that occupies the slot. In certain circumstances it is possible to paste a preset into an existing plugin (see *Paste [plugin name] Preset* below).

### **ENABLE SIDECHAIN**

Enables or disables the plugin's sidechain key input when an active sidechain is patched to an appropriate plugin. Sidechain sources are established at the top of the Plugin Pane. Plugins with an active sidechain have a drop-down menu (S/C) that patches the sidechain source.



## Plugin Presets

### **PASTE [PLUGIN NAME] PRESET**

Pastes presets from a copied plugin to another plugin in the same family (e.g., Q10 to Q6, or L1 Ultramaximizer to L1 Limiter, etc.). This does not replace the plugin, only the presets.

You cannot copy and paste presets between plugins that are not in the same family of plugins. You can, for example, paste a preset from L3 Multimaximizer to L3LL Multimaximizer, but you can't paste that L3 Multimaximizer preset to L1 Limiter or SSL G Channel. If it's not possible to paste a preset to a plugin, the *Paste [plugin name] Preset* menu item will not be available.

## Latency Section

### **LATENCY**

Indicates the delay introduced by the plugin or external insert, displayed in samples and milliseconds.

### **RACK LATENCY**

Indicates the total latency of all plugins and inserts in the rack. If no latency is declared by any of the plugins in the rack, both latency menu items will be grayed out.

### **LATENCY COMPENSATION ON/OFF**

Removes the highlighted plugin from the rack's latency compensation calculations. This is useful if you have one or more plugins with unusually large latencies and you don't want to delay the entire rack to match these "slow" plugins. Turning off latency compensation does not eliminate the plugin's delay, so it may become out of sync with the rest of the rack.



## External Inserts

You can add external inserts to a plugin rack. An external insert follows the same routing path as plugins and can be moved up and down the rack to change its position in the processing chain.

### Using an External Insert

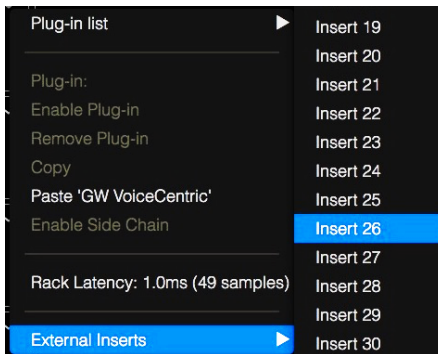

- 1 Choose a plugin slot in the rack.
- 2 Select External Inserts from the Plugin Menu.
- 3 Choose an available insert from the menu.

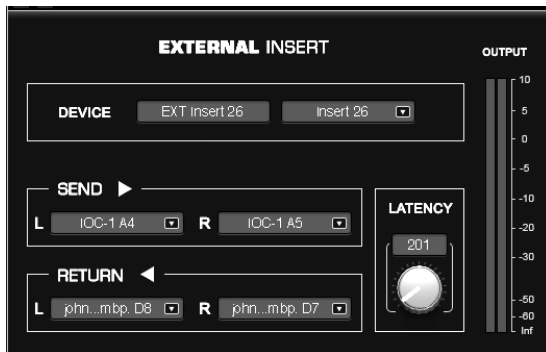

- 4 Click on the External Insert icon to open the control page.
- 5 Select the physical send and return I/Os using the drop-down menus. I/Os must be compatible with the rack configuration.
- 6 Use the Device cell to rename the insert, if needed. Use the Insert drop-down menu to move between inserts. If no send is assigned, the insert will be bypassed. It remains in the rack and its place in the processing chain is unchanged.

A multi-channel full-scale meter indicates the level of the return signal.

The Latency knob is used to adjust the amount of delay added to the signal returning from the external device.

Unlike a plugin, an external insert does not declare its delay to the latency compensation engine, so this must be done manually.



## Recall-Safe Plugin



Recall-Safe Plugin prevents plugin parameter changes during snapshot changes. In this mode, the plugin is unaffected by snapshot changes, even if the plugin is within the scope of a snapshot change and has not been set as recall-safe in the Show window (see Show window > Recall Safe).

Recall Safe is indicated with a green *Safe* indicator beneath the plugin icon.

## Plugin Position in the Rack

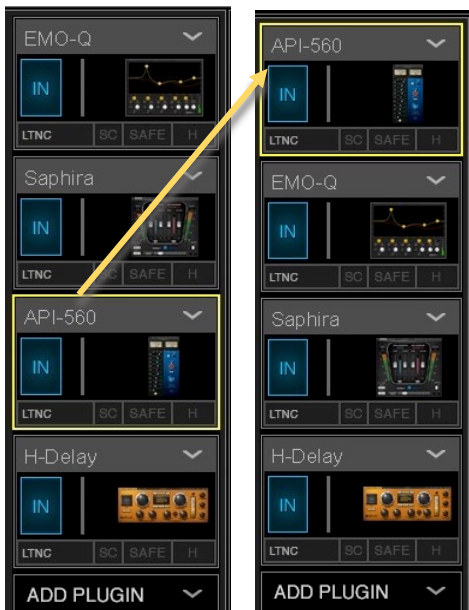

Drag a plugin or external insert icon up or down the rack to change its position in the processing chain.

In this example, an API-560 EQ is in slot #3. Slide its icon to slot #1 and the other plugins will ripple downward. This will alter the plugin's place in the signal flow and will likely alter its relationship with the other plugins in the rack.



**Note:** Repositioning a plugin requires the rack to re-clock, which may result in a click or dropout. Do not move plugins at times when this is not acceptable. Bypassing a plugin or changing its parameters can be done at any time.



## Touch and Slide Control

Any control can be adjusted with the Touch and Slide control, which is right of the plugin pane. This includes SuperRack controls such as Input Gain, as well as plugin controls.



Touch a controller to assign it to the Touch and Slide controller.

The name of the control being moved by the controller is shown in the bottom value box. The control's value is shown at the top.





## *Rack Presets*

Presets for one entire rack—input, plugins chainer, plugins settings, and output—are managed from the Racks drop-down menu, which is in the Top Bar. Functions include:

- Load factory presets
- Create, load, and export user presets
- Save presets
- Copy, paste, and rename presets
- Update rack to preset
- Turn rack recall-safe on or off

The Racks menu is described in Part 2: [Top Bar](#).



## Part 6: Overview Windows

The Overview Windows provide a side-by-side view of every rack in a session. From here you can easily see the condition of all of your racks and control them. All rack functions, except plugin settings and input and output A/B selections, can be controlled directly from the Overview window. Complete plugin interfaces can be accessed with one click.

### Two Overview windows

There are two identical Overview windows: Overview 1 and Overview 2. Having two windows lets you view and control two different modes or two different layers at the same time. You can, for example, set one view on Rack mode, Layer 17–32, and the other to Dugan mode, Layer 1–16. This is a fast and efficient way to control your racks.

### Rack controls

- Rack input and output routing
- Input and output level adjust
- Rack In/Out (bypass)
- Plugins: insert, remove, bypass, disable, load, save, copy, and paste presets  
Click on a plugin's icon to open its plugin pane for complete control. This also opens that rack's Rack window.
- Mute rack

### Rack displays

- Input and output meters. The number of bars in the input and output meters reflects the number of channels in the rack's I/O device patching.
- Plugins chainer
- Rack latency
- Rack link group and latency group assignments

Rack signal flow is from top to bottom.

NOTE: Racks in the Overview Window are controlled in the same way as in the Racks view—only their layouts are different. With that in mind, this chapter provides only what is required to patch audio through a rack, control levels, and insert and access plugins. To learn more about controlling a rack and its plugins, refer to Part 5: [Rack Window](#) of this user guide.



## Overview Window—Sections

The Overview window is divided into three logical sections: One determines which racks are displayed and available for control, another section sets what kind of action will be applied to the racks, and then there are the racks themselves, where processing is done.



### 1 Layers

A SuperRack session can have up to 64 racks. These racks are organized into four layers of racks, each with 16 visible racks. This organization is typical of digital mixing consoles. There are three types of layers:

- Four 16-rack **Factory** layers. These provide complete control of each visible rack.
- A **Wide View** in which you can view and control all of the racks at once, up to 64 racks. This affords complete oversight, but it offers less controls per rack.



- A multi-page **Custom** layer that enables you to create a layer consisting of any combination of racks, in any order.

## 2 Modes

A mode determines what sort of processing is currently being controlled on the racks: Plugin (Rack) processing or Dugan Speech automixer processing. Mode selection affects only the center section. It does not affect Input or Output settings, cue, mute, or meters. The Rack mode presents an eight-plugin chainer for each rack.

The Dugan Speech automixer is a processor used to control several microphones in situations where many people are talking, possibly several at the same time. It's described at the end of this chapter.

## 3 Racks

These are the chainers where plugins are inserted and controlled.



## 1 Layers

### Factory Layers



Use the Layers buttons to choose one of the four factory layers. A factory layer can have up to 16 racks. The number of racks in a session, and therefore the number of layers, is configured in the Settings page. Inactive layers or parts of layers are empty.

We suggest that you create a session whose size approximately matches the number racks you will be using. Unnecessary layers don't do you any good and can be distracting.

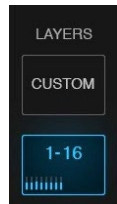

Active layer buttons have small output meters with peak indicators for each rack. Click on the button to clear the indicator.

The sequence of racks in a factory layer is fixed.

### Custom Layers

To re-sequence rack order or combine racks from several layers in one view, create Custom layers. Each of the four custom layer pages can house up to 16 racks. Racks from any factory layer can be combined in custom layers. This lets you change the sequence of racks in a layer or combine racks from several layers into one custom view.

Double-click on a custom layer page to rename it.



## USING CUSTOM LAYERS

To assign racks to a Custom Layer:

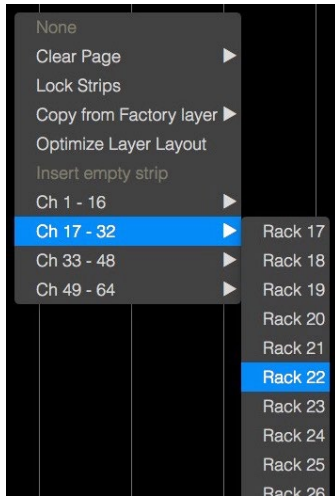

- Chose “Custom Layers.”
- Click on an empty strip. Use the drop-down menu to assign a rack to the strip.
- Racks can be added in any order.
- Racks can be added from any layer.
- Click and drag on the channel name at the top of a strip to re-arrange the channel strip sequence.

If there is already a rack in a slot, you will need to hold Ctrl while clicking on the rack to access the menu.

There are other options available in the Custom layer drop-down menu:

<b>None</b>	Removes the selected rack from the custom layer page.
<b>Clear Page</b>	Removes all racks from the current custom layer page.
<b>Lock Strips</b>	Prevents rack strips in the current page from being repositioned.
<b>Copy from Factory Layer</b>	Copies all of the racks of a factory layer and pastes them to the current page of the custom layer.
<b>Optimize Layer Layout</b>	Removes blank slots and moves all populated rack strips to the left.
<b>Insert Empty Strip</b>	Inserts a blank strip to the left of the selected populated strip.



## Wide View Layer

The button “1–64” opens a wide view that displays all of the racks in the current session. Each rack shows its name, input and output I/O device assignment menu, output metering, rack latency, and In and Mute buttons.

The screenshot displays the Wide View Layer interface, showing a grid of 64 racks (Rack 1 to Rack 64). Each rack panel includes:

- Name:** A dropdown menu for the rack name (e.g., "johrp-h", "IOC-1", "IOS-1").
- LTNC:** Latency/Throughput metering with a scale from 0 to -30.
- Output Metering:** A vertical bar graph showing signal levels.
- IN M:** Input and Mute buttons.

The interface also features a top navigation bar with tabs: OVERVIEW 1, OVERVIEW 2, RACK, SHOW, PATCH, and SETUP. The right sidebar contains:

- HOT PLUGINS:** A grid of 16 slots for active plugins (e.g., Rack 2 API-2500, Rack 2 Manny...\_p1eD).
- USER KEYS:** A grid of 16 slots for user-defined shortcuts (e.g., SavSes, LdSes, CpyRa, PasPlg).

On the left side, there are controls for MODE (RACKS, DUGAN, AUTO ROUTE), LAYERS (CUSTOM), and a rack selection menu (1-16, 17-32, 33-48, 49-64, 1-64).



## 2 Modes

The Mode setting determines what is displayed in the Overview window.



In the **Racks** mode, the plugin chainer racks are displayed. Each rack can host up to eight plugins.

In the **Dugan** mode, plugin chainers are replaced with the controls for the Dugan Speech Automixer. This processor is used to control a group of live microphones in multi-speaker environments. It turns up mics where someone is talking and turns them down where people are quiet. It's commonly used in situations such as roundtable discussions, talk shows, debates, and the like, and is based on the hardware Dugan Automatic Microphone Mixer.

The Dugan Speech Automixer requires a separate license. When a license is not present, the Dugan button is grayed out. For more information, refer to the section at the end of this user chapter, “Using the Dugan Speech Automixer.”





### 3 Racks

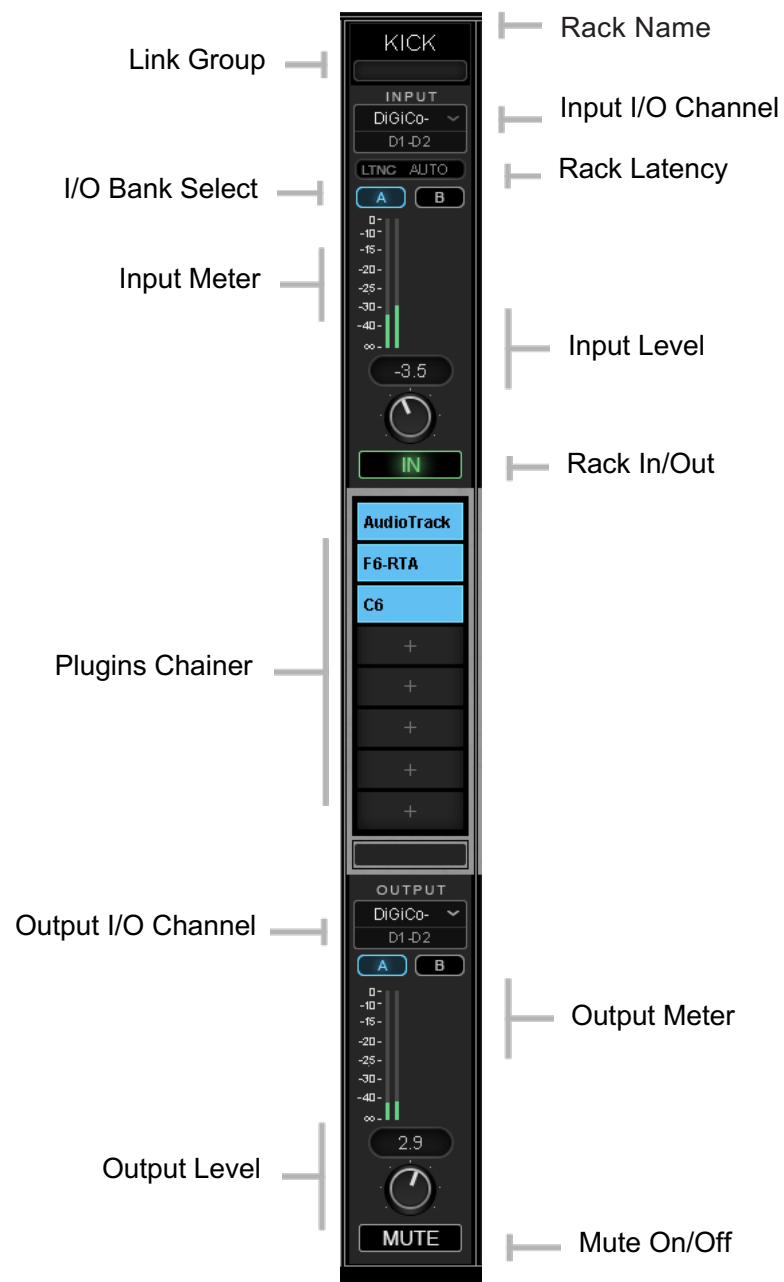

In the Overview window, each rack is a condensed view of the controls, meters and plugins you see in the Rack window. Its organization closely resembles that of a mixing console channel strip. Click on a plugin button to open the complete interface of the plugin.

A selected rack is shaded light gray and is outlined in white. Its name is displayed in the Name box in the Top Bar. To view the Rack view of the selected rack, click on the Rack tab in the Top Bar.

Click on a populated plugin slot to jump to its complete plugin pane in the Rack window.

One rack at a time can be selected.



## Selecting Rack Input

Assigning rack inputs in the Overview window is the same as in the Rack menu.

### Choose an Input Set

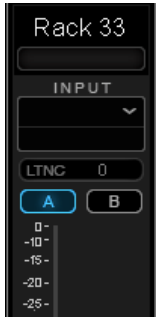

Each rack has two inputs: Input I/O Banks A and B. A rack's inputs can patch to different device channels, but they must have the same channel format. The I/O bank selector is immediately above the input meter.

Once the I/O Bank is set, you are ready to route the input channels.

### Route Inputs

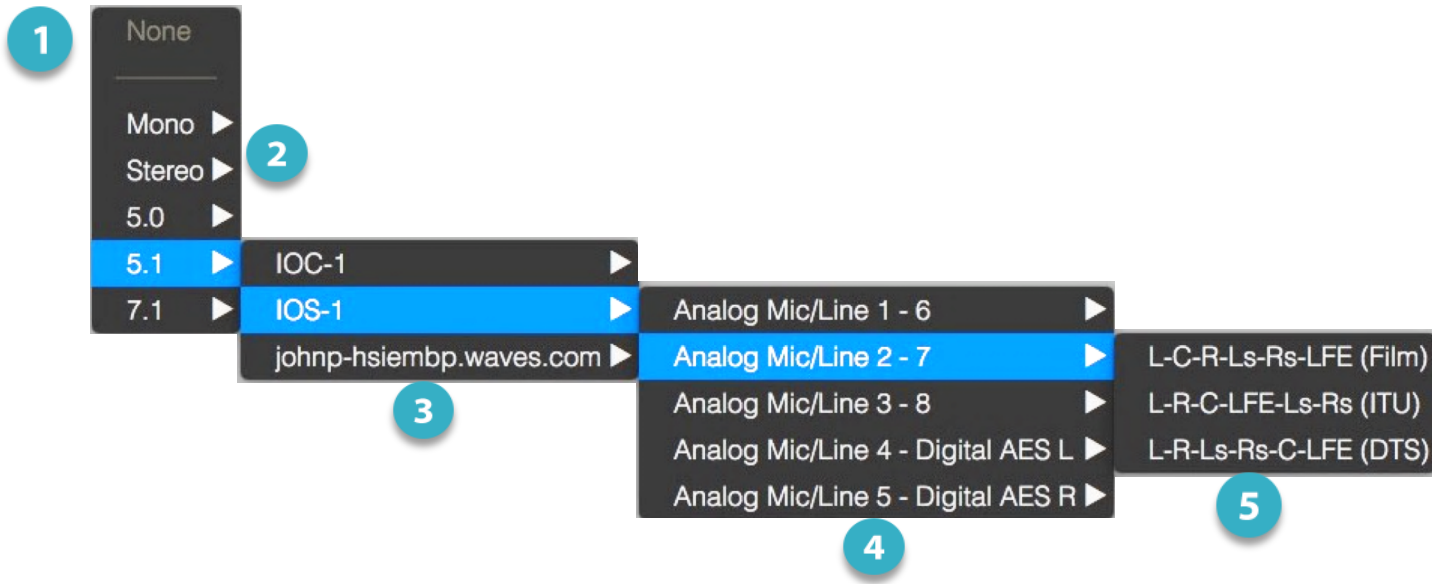

- 1 Open the drop-down **Input** menu.
- 2 **Select the format of the rack you are building** (e.g., mono, stereo, 5.1, 7.1). The Input Format selector determines the devices, I/O channels, and formats that can be selected. It also determines which plugins you can use, since a plugin must have a component that is compatible with the rack format.
- 3 **Choose an I/O device.** Only devices that can provide the requested number of I/O channels are listed.
- 4 **Select the range of device channels.** If there are not enough free I/O channels on this device, you'll be presented with a list of patches that must be removed in order to make the new assignments. You can accept the new configuration (removing certain patches) or select Cancel, which allows you to reconsider your patching with a different device.
- 5 **Set the channel format** (e.g., L-C-R-S, L-CL-C-CR-LS-RS-LFE, etc.). This sets how channels in the stream are arranged. For example, as shown above, a 5.0 channel stream can be formatted as L-C-R-Ls-Rs or L-R-C-Ls-Rs or L-R-Ls-Rs-C.

In the example above, this is the rack's input patching:

- Channel size: 5.0
- Device: IOS #1
- I/O channels: Analog Mic/Line 4–8 (five I/O channels are allotted to the 5.0 channel size)
- Format: L-R-Ls-Rs-C (DTS format).

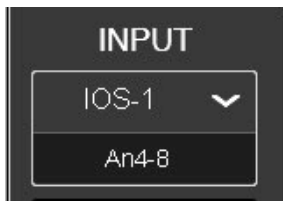

The selected I/O device and I/O channels are shown in the input cell.



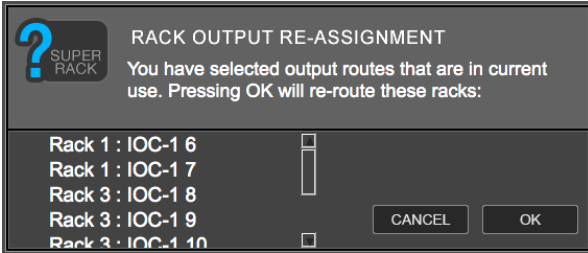

If your I/O selection includes I/O channels that are currently in use, you will see this prompt. Select **OK** to make the new assignment and un-assign the indicated I/O channels. Click **Cancel** to maintain the existing assignments. Choose different I/O channels for the new assignment.



## Input meter



Each rack has a full-scale Input meter. The number of meter bars reflects the format of the I/O device. The meter on the far left indicates a stereo input, and therefore a stereo rack.

Meters turn red (middle image) when the input signal is clipping. Behavior for clip level and clip hold are controlled in the Settings page. On the right is a 5.1-channel input.

Input gain is controlled with the knob below the meter. Alt+Click on the knob to reset.

## Input Gain and Bypass

Use the Input Gain knob to adjust input gain to the rack. Knob position is indicated in the value box.

Range: -18 dB to +18 dB



The IN switch serves as the rack's bypass.

IN Normal rack operation

Not IN Rack bypass



## Plugin Chainer



The Plugin Chainer provides an overview of all the plugins in a rack. Use it to add, delete, bypass, deactivate, and move/copy plugins.

Click on a plugin button to access the plugin's complete control interface in the Rack window

## Inserting a Plugin

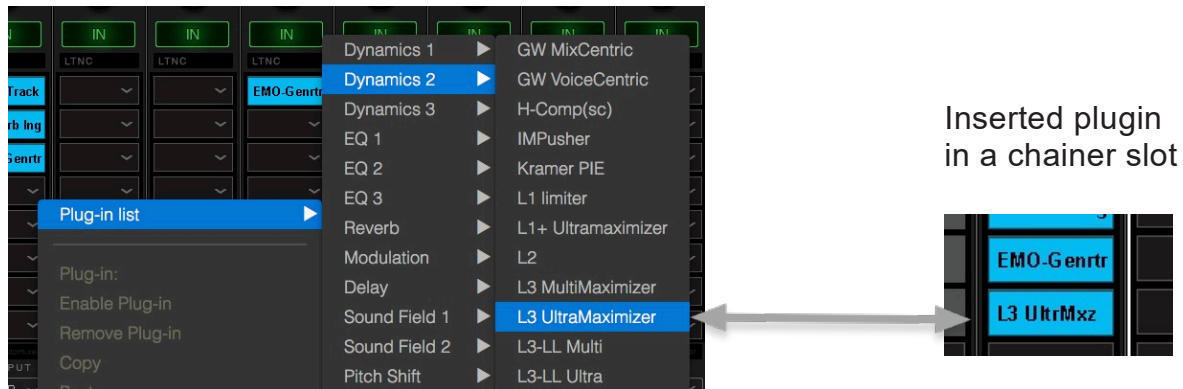

To add a plugin to a plugin chainer:

Click the + (plus) symbol on an empty slot. This opens the Plugin menu (note: in the Rack window, click on the down-arrow to open this menu). If the plugin slot is already populated, right-click on the icon. Open the Plugin List sub-menu and choose from among the available plugins. Its name then appears in the chainer slot. Only plugins that are compatible with the rack's channel type will be shown.



## Other Plugin Menu Items

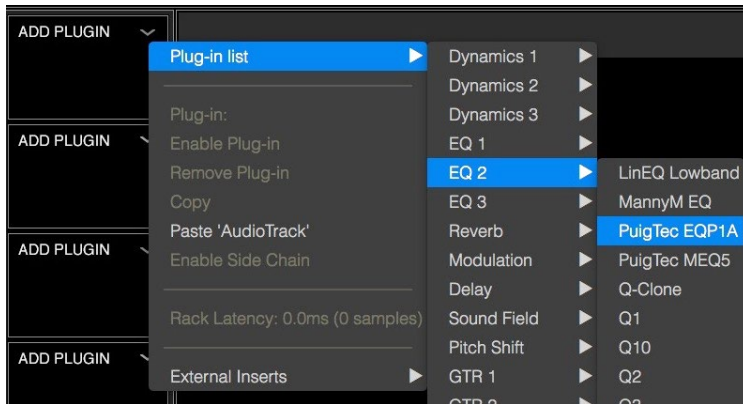

Once a plugin has been instantiated in a plugin slot, more menu items are available in the Plugins menu. These options are used to copy and paste plugin presets, set plugin mode, monitor latency, and more.

Plugins are managed through the Plugins drop-down menu in both the Rack window and the Overview window. These menu items are explained in [Part 5: Rack Window](#). In the current section we cover only the essential Plugins menu items.

### Bypass

Bypasses the plugin while keeping it in the processing chain. Bypassing a plugin does not alter its DSP load. A bypassed plugin button appears white in the Plugin Chainer (to shortcut, hold Ctrl+ALT+click).

### Disable Plugin

Removes the plugin from the processing chain without deleting it from the rack. Disabling plugins may reduce rack latency and DSP load. You can re-enable a disabled plugin without losing its settings, controls, or automation assignments. When a plugin is disabled, its name will remain visible, but the slot will be solid gray.

### Remove Plugin

Deletes the plugin from the slot. All settings and control assignments are lost. You can also remove a plugin by dragging it left or right, off the chainer rack.

Note: Holding the ALT key while selecting Insert, Remove, or Disable extends the action across an entire row. This affects ALL layers, not just the visible one.



### **Latency Compensation On/Off**

Removes the plugin from plugin latency compensation calculations. The plugin remains active, and its latency does not change, but its latency is no longer reported to the delay compensation engine.

### **Latency**

Indicates the delay introduced by the plugin or external insert. Displayed in samples and milliseconds.

### **Rack Latency**

Indicates the total latency of all plugins and inserts in the rack.

## **Managing Plugin Icons in the Overview Window**

### **Opening, disabling, and removing plugins directly from the Plugin Chainer**

- Single click: Opens the plugin pane of the plugin or external insert.
- Right click: Opens the plugins menu.
- Ctrl + click: Disables the plugin and removes it from the DSP processor.
- Drag an icon outside the chainer area: Removes the plugin (this cannot be undone).

### **Moving and copying plugins**

- Drag a plugin icon vertically from its position in the same rack. Presets are moved with the plugin.
- Drag a plugin horizontally to move it to *another rack*.
- Alt + drag an icon to copy it to another rack.
- Move a mono plugin module to a stereo rack and the plugin becomes a stereo module. The mono plugin's settings will be applied to both sides of the stereo module. If a stereo plugin is moved to a mono channel, the settings of the left stereo channel are applied to the mono.





## Plugin icon indicators

Plugin status is indicated by its icon's shading.

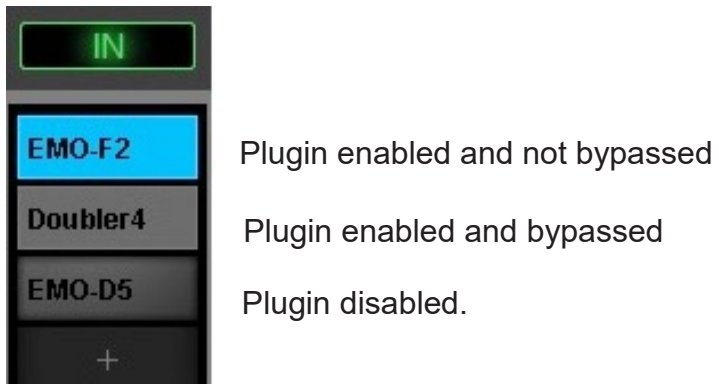

- ! Note: Adding, removing, disabling, or moving a plugin changes the structure of the plugin chainer, which can result in a brief interruption. Do not make these changes when a dropout is not acceptable.
- Bypassing a plugin or changing its parameters can be done at any time.

## Latency Indicator



The latency box displays the total latency of the rack.



## Output Section



The output section patches the rack to an output device. Rack output gain can also be controlled here.

### Output routing

Use this drop-down menu to select the output I/O device and the rack output type.

### Output Gain and Meter

Output gain control, -18 dB to +18 dB. Full-scale output meters match the I/O device format. The meter is red when rack output level clips. Clip threshold and clip hold are controlled in the Settings page.

### Mute

Mutes the rack.



## Dugan Automixer:

The Dugan Speech automixer is a way to control a group of live microphones in multi-speaker environments. It turns up mics where someone is talking and turns them down where people are quiet. It's commonly used in situations such as roundtable discussions, talk shows, debates (and the like) and is based on the hardware Dugan Automatic Microphone Mixer.



- 1 Dugan Mode Selector Select Dugan mode to access the Dugan Speech Automixer
- 2 Dugan Engine ON/Off Turns the Dugan processor on or off
- 3 Recall Safe Sets this rack's Dugan Speech Automixer to recall safe
- 4 Reset Sets this rack's Dugan Speech Automixer to default settings
- 5 Mute Channel Group Selects rack mute groups.
- 6 Override Channel Group Mutes all microphones, except for one (usually the host or chairperson).
- 7 Weight Control Assigns a priority to designated speakers. This governs sensitivity, not level.
- 8 Global Mute When Global Mute is selected, all members of the selected Dugan Speech automix group are muted.
- 9 Global Override Overrides channel mute for specified channels in a group
- 10 Operation Mode When this switch is off, the automix process is ignored and the signal passes through the processor at unity gain.



## BASIC OPERATION

Automixer's position in the signal flow of a rack is *after processing* and *after fader*. It works on mono or stereo racks.

1. Click the **Dugan Engine On** button in the Global Control panel (left side).
2. Use the **Dugan Speech Plugin button** at the top of each panel to enable the automixer on all racks for which Dugan Speech automixing is desired. Disable all non-live-talking racks where automixing will not be used. Disabled racks are grayed out.
3. Click the **Auto** button to turn on the automixer for that rack. Effective automixing depends on correct input gains for each rack. Adjust each rack's input gain so that the level display is green.
4. Set the **Weight** controls to balance the rack's automix gain and establish the priority of one speaker over others. Weight levels can be changed by dragging the faders up or down.
5. Assign racks to **Dugan groups**. A group functions as a separate and independent automatic mixer. Each rack can be assigned to one of three groups: a, b, or c.

For detailed instructions, please refer to the [Waves Dugan Automixer User Guide](#) on the Waves download page.

Dugan Speech requires a separate license. If a license is not found, the Dugan mode selector button will be grayed out.



# Part 7: Show Window

Use the Show Window to set up and manage your sessions, snapshots, and recall safe settings. The Show Window is divided into three pages; select them using the sidebar buttons:

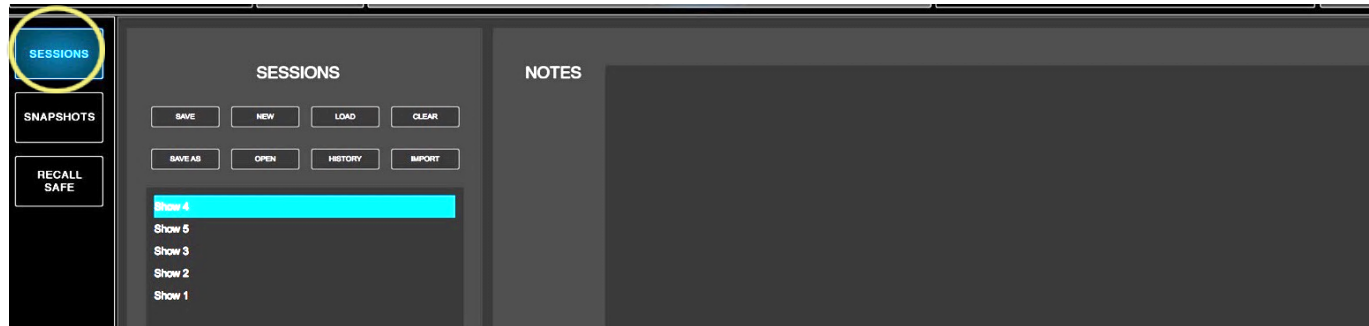

**Sessions Page**  
Create, save, and open sessions. Import rack presets from a session file. Open History files.

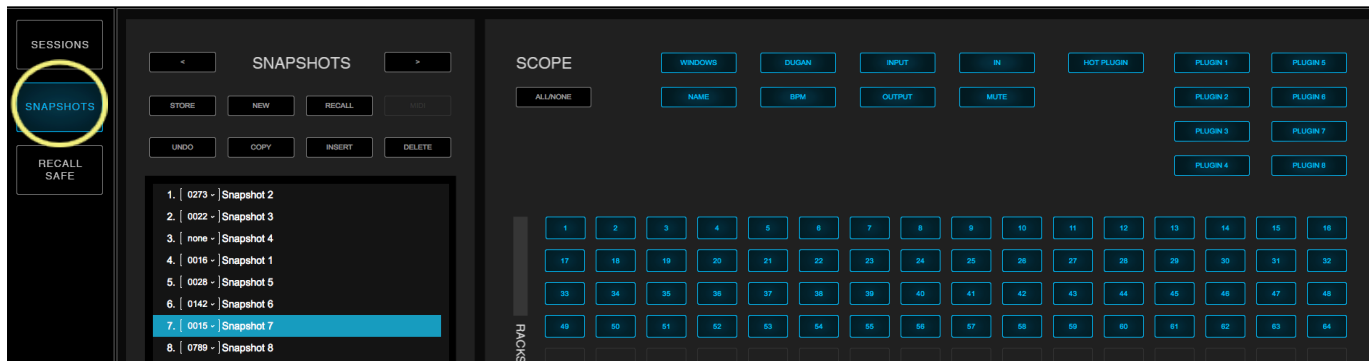

**Snapshots Page**  
Create, store, and recall snapshots. Set snapshot scope.

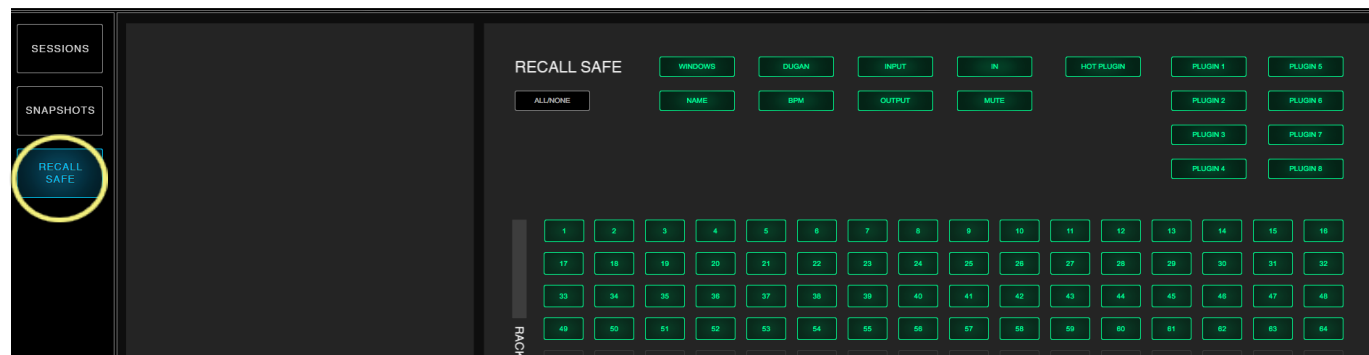

**Recall Safe**  
Define recall safe parameters for racks, plugins, hot plugins, and more.



## Sessions Page

All of these settings load with a session:

- Inventory
- External patching
- Channel presets and rack configuration
- Plugin presets
- System preferences
- Settings
- User keys and hot plugins
- All user settings

The screenshot shows the 'Sessions Page' interface for 'Rack 1'. The top navigation bar includes 'OVERVIEW 1', 'OVERVIEW 2', 'RACK', 'SHOW', 'PATCH', and 'SETUP'. The right side shows '1:Snapshot 2' and 'Session 16\*' with status indicators for SERVER I/O/DAW, 48kHz AUDIO, REMOTE MIRROR, and CPU MEM. The left sidebar has 'SESSIONS', 'SNAPSHOTS', and 'RECALL SAFE' buttons. The main area is divided into 'SESSIONS' and 'NOTES' sections. The 'SESSIONS' section contains a list of sessions from Session 2 to Session 20, with 'Session 18' highlighted. Below the list are 'TEMPLATES' buttons for 'SAVE' and 'LOAD'. The 'NOTES' section contains the text 'The quick brown fox jumps over the lazy dog.' and a 'DETAILS' section for 'Session 18' showing 'Modified: 2019-02-19 15:31:25' and 'File Size: 1314816'. Numbered callouts (1-12) point to various UI elements: 1 (Save button), 2 (Session 18 in list), 3 (New button), 4 (Save As button), 5 (Session label), 6 (Session 18 in list), 7 (Clear button), 8 (Session 15 in list), 9 (Save button), 10 (Load button), 11 (Notes text), and 12 (Details text).



1	Save	<p>If a session has not been saved previously, Save will create a new file. Otherwise, it replaces the existing file. A session is normally saved in the default folder:</p> <p>Mac: /Users/Shared/Waves/SuperRack SoundGrid/Sessions          Windows: Users\Public\Waves\ SuperRack SoundGrid/Sessions</p> <p>A navigation window enables you to place the session anywhere you prefer. See <i>File Organization</i>, later in this chapter.</p>
2	Save As	Saves a copy of the current session.
3	New	Creates a new session.
4	Open	Navigates to a session file that is not displayed in the Sessions list.
5	Load	Loads the selected session displayed in the Sessions list.
9	History	Opens a browser that shows all auto-saved session files.
11	Clear	Clears the Sessions List. This does not delete the sessions. Sessions can be returned to the Sessions List using the Open button.
8	Sessions List	Shows all available sessions created since the last Clear.
9	Save Template	Saves current session as a template. Templates are stored in the Templates folder.
10	Load Template	Loads a factory or user-made template. Templates are used to create new sessions based on previous sessions.
11	User Session Notes	This large notepad is used for notes about the session, the venue, or anything else you want to write.
12	Session File Details	Displays session file name, creation time, and size, as reported by the operating system.



## Sessions List

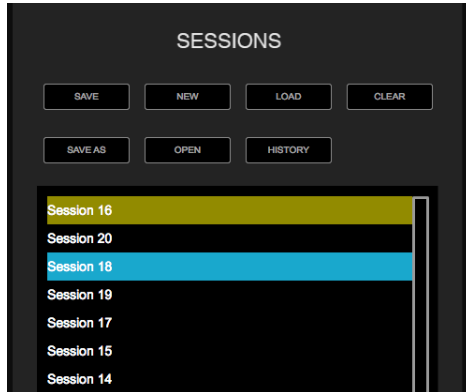

The Sessions list shows the sessions that have been created or modified in the Sessions window. It is used to select, copy, and load sessions.

A selected session is highlighted in blue and the currently loaded one is highlighted in green. Notes associated with the selected session are shown in the Notes section.

## Saving a Session

Sessions can be saved at any user-defined location, but a centralized Sessions folder is provided for convenience.

Mac: /Users/Shared/Waves/SuperRack SoundGrid/Sessions

Mac: /Users/Shared/Waves/SuperRack /Sessions

Windows: Users\Public\Waves\ SuperRack SoundGrid/Sessions

Windows: Users\Public\Waves\SuperRack/Sessions

SuperRack sessions use the “sprk” extension.

There are two recovery files in this folder: “CurrentSPRK.dat-journal” and “CurrentSPRK.dat.” Do not delete or move them.

## SAVING A SESSION AFTER MIXER CONFIGURATION HAS CHANGED

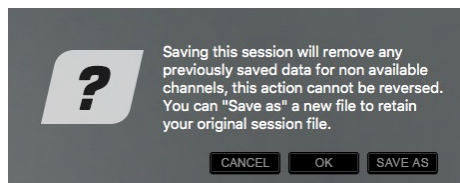

You can change the number of racks at any time. If the number of racks in the session has been reduced since the last time it was saved, this prompt will appear when you save.

Removing racks clearly results in a loss of channel information. A normal Save at this point would eliminate all settings from the removed channels, since it overwrites the session file. To preserve that information, we suggest you do a **Save As** with a different file name. If you forget to do this, you can always recall a previous History file.

The number of racks is established in the Settings page.





## Loading a Session

Load a session with the “Load” button above the Sessions list or from the Sessions drop-down menu in the Top Bar.

**!** **Important:** Loading a session can result in an audio dropout or a click. Do not load a new session when this is not acceptable.

### LOADING A SESSION FROM THE SESSIONS LIST

The **Load** command loads the selected session (blue) from the Sessions list. This list includes all sessions that have been created, loaded, or imported since the list was last cleared. **Open** lets you navigate to any session.

If the current session has changed since it was last saved, there will be a prompt asking if you’d like to save it before loading the new session. If the new session has the same number of racks and calls for the same or similar I/O inventory, then the new session will load immediately. When working on the same SuperRack repeatedly, this is often the case.

### LOADING SESSIONS FROM THE SESSION MENU

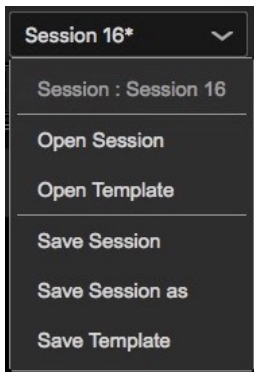

The Session menu is located on the right side of the Top Bar. It’s a quick way to load and save sessions and templates.



## Resolving Load Errors

If the system inventory and number of racks of the session you're loading do not match the current configuration, SuperRack must reconcile the mismatch before loading the session.

### Example 1

The saved session has more racks than does the current SuperRack configuration.

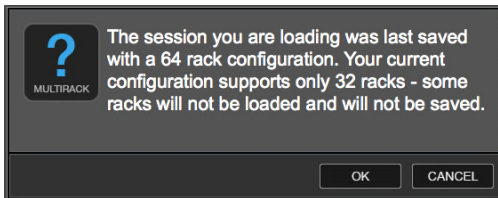

In this case, the new session calls for 64 racks, while the system inventory has only 32. The session will load the first 32 racks and drop the last 32. This structure becomes permanent when the user performs a save on the "reduced" session—it cannot be undone. Make a copy ("Save As") before you save the reduced session.

### Example 2

The I/O inventory of the saved session does not match the current inventory.

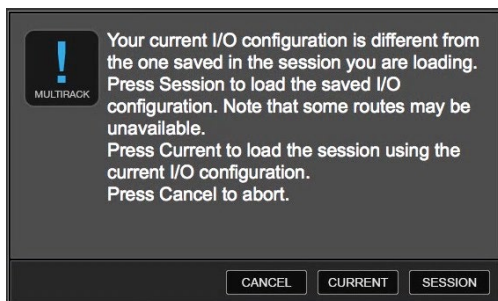

Whenever the saved session's I/O inventory is not the same as that of the mixer, there is a chance that certain routes cannot be supported. If, for example, the session calls for a 128-channel MADI device, while the current I/O hardware in the same slot is an 8-channel I/O, it will be difficult to provide the session with the I/O channels it needs.

The Session Load routine provides two strategies when sessions and inventory are mismatched.



**Option 1: Session** – The session loads completely and its saved inventory replaces whatever is now in the inventory. If a device is present in the inventory but inactive (turned off, disconnected, defective, or not present) the device icon will be gray. The session’s routing does not change, but the I/O channels are unavailable

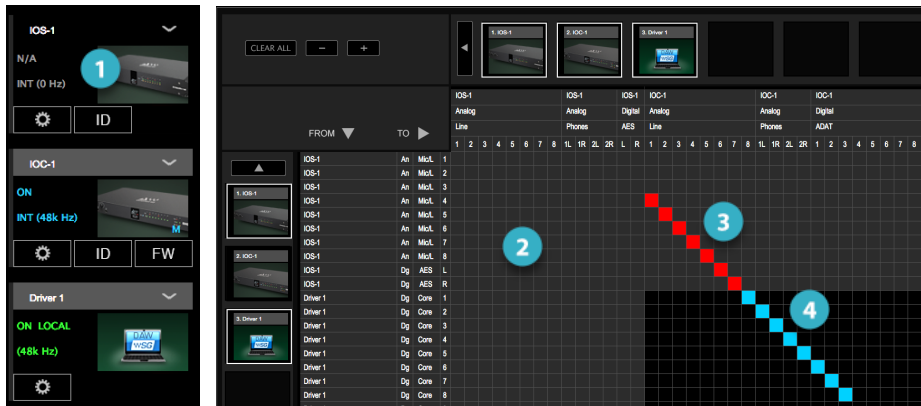

- 1 IOS-1 is in the inventory but is not available.
- 2 Patching to IOS-1 is not possible. This “illegal” patch area is shaded light gray.
- 3 A patch to an unavailable device is red. The patch will become valid when the appropriate device is made available.
- 4 Valid patches are blue.

When a missing device is reassigned, the session will load completely. Routing to or from unavailable devices is not possible in any window.

**Option 2: Current** – The saved session loads into the existing I/O inventory. The saved inventory is replaced with a new one that reflects the current device inventory. SuperRack searches each device slot for an assigned device that will match the needs of the session. The device in the slot needn’t be precisely what the session requests, but it must have sufficient I/O channels.

Inventory is catalogued by slot, so an appropriate device must be found in the same slot as the session calls for. The original session’s patches for the I/O in a specific slot will be patched depending on the current channel count. For example:

- The session calls for a DiGiGrid IOX device in slot 1, and another in slot 2 (12 I/O channels each).
- The current inventory has DiGiGrid MGBs in slots 1 and 2 (up to 128 I/O channels each).
- When you load the session into this inventory, all the patches will be intact. The first 12 I/O channels from each MGB DiGiGrid interface will be patched, but the remaining channels are unused.



## Templates



A template is a session based on a previous session or a factory preset. It loads all SuperRack settings (except the I/O inventory), which facilitates moving projects between systems whose inventories are not identical.

When creating a new session, it's common to begin with a template from the Presets menu.

A newly loaded template does not appear in the Sessions list. Once you open a template and save it as a session under the desired name, it will show up in the Sessions list. Use the **Template Save** button to create a session template from the current session. Templates are stored in the Templates folder:

- Mac: Users/Shared/Waves Audio/SuperRack SoundGrid/templates  
Users/Shared/Waves Audio/SuperRack/templates
- Windows: Users\Public\Waves\ SuperRack SoundGrid\templates  
Users\Public\Waves\ SuperRack \templates

## Auto-Save Sessions (History)

SuperRack can save sessions automatically, either at user-defined intervals or each time snapshots are saved or recalled. Auto-save settings are controlled in the Mixer Settings page (Setup > Settings > History).

There are three Auto-Save controls:

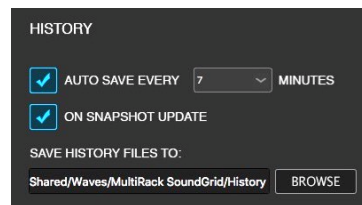

No Auto-Save

There are no automatic saves. No History files are created.

Auto-Save

New History files are created at user-defined time intervals.













On Snapshot Update

A History file is created each time a snapshot is recalled or stored.

In its default setting, Auto-Save is not active. If you want to use this feature, switch it on manually.



Click the History button in the Sessions page to view all History files.

 Session 44_20190516_152249.sprk	SuperRack Soundgrid Session Database
 Session 44_20190516_152153.sprk	SuperRack Soundgrid Session Database
 Session 44_20190516_152148.sprk	SuperRack Soundgrid Session Database
 Session 18_20190516_152106.sprk	SuperRack Soundgrid Session Database
 Session 18_20190516_152052.sprk	SuperRack Soundgrid Session Database
 Session 18_20190516_152042.sprk	SuperRack Soundgrid Session Database
 Session 18_20190516_152033.sprk	SuperRack Soundgrid Session Database
 Session 45_20190516_151949.sprk	SuperRack Soundgrid Session Database
 Session 45_20190516_151649.sprk	SuperRack Soundgrid Session Database
 Session 45_20190516_151349.sprk	SuperRack Soundgrid Session Database
 Session 45_20190516_151049.sprk	SuperRack Soundgrid Session Database
 Session 45_20190516_150947.sprk	SuperRack Soundgrid Session Database

A history file is a complete SuperRack session. To prevent mishaps, SuperRack does not delete auto-saved files. This provides access to all session information saved throughout a project.

History files are named based on session name, followed by date stamp and series number. Use the host computer to copy, move, and delete files. History files can be saved to any location. Set the save location in the Setup > Settings page. We recommend saving in the default History file folder:

Mac: Users/Shared/Waves Audio/SuperRack SoundGrid/history  
Windows: Users\Public\Waves\SuperRack\history



## Snapshots Page

Use the Snapshots page to create, recall, set the scope, and load and save the snapshots in a session. “Snapshot” refers to all settings used in the current SuperRack configuration. In this context, “all settings” refers to:

- Racks and their parameters (in, mute, gains, plugins, plugin sidechain, A/B select)
- Plugins and their parameters
- Hot Plugin panel update
- Windows – what windows are open and where they are located on the screen.
- Dugan Automixer settings
- Global BPM

The screenshot displays the SuperRack Snapshots page. The interface is divided into several sections:

- Top Bar:** Shows 'Rack 1', 'Link', 'Latency', and navigation tabs for 'OVERVIEW 1', 'OVERVIEW 2', 'RACK', 'SHOW', 'PATCH', and 'SETUP'. It also displays system information like '10:Snapshot 10', 'Untitled', '120 BPM', and 'SUPER RACK WSG'.
- Left Panel:** Contains 'SESSIONS', 'SNAPSHOTS', and 'RECALL SAFE' buttons.
- SNAPSHOTS Section:** Features a list of snapshots with numbered callouts (1-7) for actions: 1. STORE, 2. UNDO, 3. NEW, 4. COPY, 5. RECALL, 6. INSERT, 7. DELETE. A list of snapshots is shown below, with callout 8 at the top and callout 9 pointing to Snapshot 7. Snapshot 10 is highlighted in yellow.
- SCOPE Section:** Includes buttons for 'WINDOWS', 'DUGAN', 'INPUT', 'IN', 'HOT PLUGIN', 'PLUGIN 1-8', 'NAME', 'BPM', 'OUTPUT', and 'MUTE'. Callout 11 points to the 'OUTPUT' button. Below is a grid of 64 buttons labeled 'RACKS' (1-64). Callout 10 points to rack 33.
- NOTES Section:** A large text area for notes, with callout 14 pointing to it.
- Bottom Left:** A 'HOT SNAPSHOTS' dropdown menu with callout 12 pointing to it.
- Bottom Center:** A 'NOTES' label with callout 13 pointing to the text area.



- |           |                         |   |
|-----------|-------------------------|---|
| <b>1</b>  | Store                   | Updates the current snapshot and scope settings with the current SuperRack status. Replaces the existing stored snapshot.   |
| <b>2</b>  | Undo                    | Undoes the previous change.   |
| <b>3</b>  | New                     | Creates a new snapshot, based on the current SuperRack condition and scope settings. This makes a new snapshot from the current one and serves as a “Save as” function. |
| <b>4</b>  | Copy                    | Copies the selected snapshot to the clipboard. This can then be inserted back to the Snapshot list as a copy.   |
| <b>5</b>  | Recall                  | Recalls the snapshot that’s selected in the Snapshot list. The name of the recalled snapshot is displayed in the Snapshots section of the Top Bar.                      |
| <b>9</b>  | Insert                  | Pastes the copied snapshot to the list. It does not recall the snapshot.  |
| <b>11</b> | Delete                  | Deletes the selected snapshot (which is not necessarily the current one).   |
| <b>8</b>  | Previous/Next scene     | Immediately recalls previous or next scene.   |
| <b>9</b>  | Snapshots List          | A list of all snapshots that have been created, imported, or saved with the current session.  |
| <b>10</b> | Scope Section           | Sets which racks, plugins, and other controls and functions will be affected when a specific snapshot is recalled.  |
| <b>11</b> | All/None                | Selects or deselects all Scope buttons.   |
| <b>12</b> | Hot Snapshot Assignment | Designates the snapshot as a Hot Snapshot, which can be recalled from the Snapshots menu in the Top Bar or by means of User Keys.                                       |
| <b>13</b> | Notes                   | A large space for writing notes about the selected snapshot.  |
| <b>14</b> | Tear Off Notes Button   | Click to disconnect the notes pad and float it anywhere on the screen.  |



## Snapshots List

The Snapshots list works in the same manner as the Sessions list.

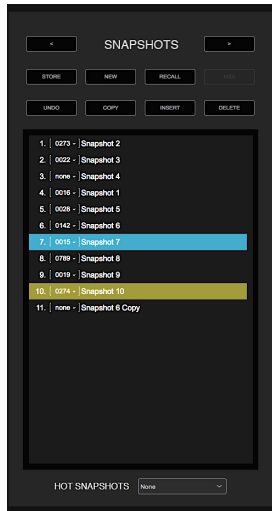

- A selected snapshot is highlighted blue, whether it is the recalled snapshot or not. A highlighted snapshot is not active until it is recalled.
- Notes associated with the selected snapshot are shown in the Notes section.
- If the current snapshot is not selected, it will be highlighted green, and the selected one will be highlighted blue.

Above the Snapshots list are two arrows. Use them to recall snapshots lower or higher than the current one in the Snapshots list.

Double-click on a snapshot to change its name.

! Clicking an arrow loads the snapshot immediately.

### STORING SNAPSHOTS IN THE SNAPSHOTS LIST

**Store** saves all mixer settings to a snapshot. If a snapshot other than the current one is selected, you will be offered two choices:

- **Current:** Store the settings in the current snapshot.
- **Selected:** Store the settings in the selected snapshot. This replaces the contents of the selected snapshot.

**New** creates a new snapshot based on the current settings.

Snapshots, unlike sessions, are not separate files. They are embedded in the sessions.





## RECALLING SNAPSHOTS FROM THE SNAPSHOTS LIST

Select a snapshot and click **Recall**.

## CHANGING THE ORDER OF THE SNAPSHOTS LIST

A snapshot's place in the Snapshots list determines its recall number, so it's important to be able to change its position. There are two ways to do this:

- Drag the snapshot to a new location.
- Copy a snapshot with the Copy button. Use the separator line to choose where the pasted snapshot will be located in the list. If the separator line is not used, then the copy will be added to the bottom of the Snapshots List. Double-click on the snapshot to change its name.

## STORING A SNAPSHOT WITH THE TOP BAR SNAPSHOT MENU

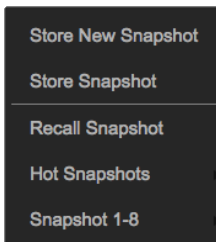

The Snapshot menu is located on the right side of the Top Bar. It's used to store and recall snapshots without leaving your current view.

A snapshot selected in this menu is recalled immediately.

The name of the current snapshot, along with its index number, is displayed in the box. If a scene has been modified since it was recalled, it is followed by an asterisk (\*).

The Top Bar Snapshot menu is described in detail in the [Top Bar](#) section of this user guide.



## Hot Snapshots

Hot Snapshots are user-assigned snapshots that are accessible for quick recall from any view.

### ASSIGNING HOT SNAPSHOTS

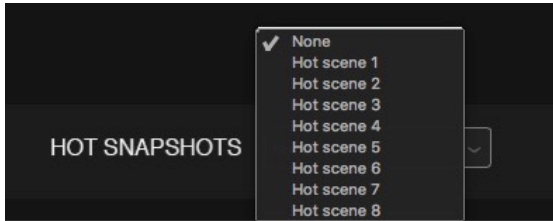

Use the menu at the bottom of the Snapshots list to assign the selected snapshot a Hot Snapshot position.

### RECALLING HOT SNAPSHOTS

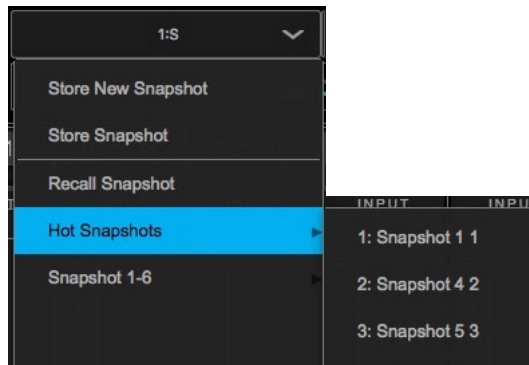

Hot Snapshots are recalled from the Snapshots menu on the Top Bar.



## MIDI Control Changes for Snapshots

The Snapshots list can be controlled with MIDI program changes. Use the MIDI control panel to set up Follow Program Change or Generate Program Change commands (Setup > System Inventory > Controllers>Device Control Panel).

### Assigning Remote IDs to Snapshots

You can manually assign a remote ID number to a snapshot. This lets you separate the listing order of the snapshots in the Snapshots List from the remote-control snapshot ordering.

If, for example, you assign snapshot number 5 the remote ID of 130, and in the MIDI Controller you assign CC Number #7 to the 129-256 range, then this MIDI CC #7 with value 1 will recall snapshot 130 (value 0 will recall 129, and so forth).

There are two ways to assign a remote ID to a snapshot:

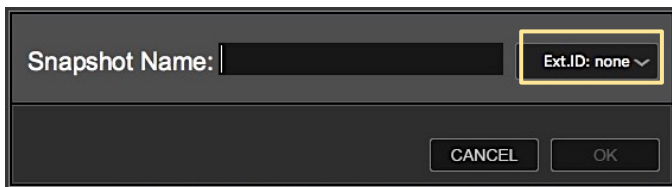

When you initially name a snapshot, you can assign an ID using the External ID drop-down menu.

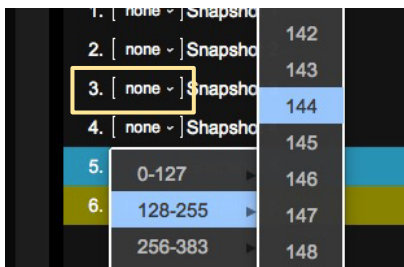

Snapshot #	Ext.ID	Snapshot Name	Remote ID
1.	[ none ]	Snapshot	142
2.	[ none ]	Snapshot	143
3.	[ none ]	Snapshot	144
4.	[ none ]	Snapshot	145
5.	0-127		146
6.	128-255		147
	256-383		148

A new snapshot will indicate the external ID as “none.” To assign an external ID to a snapshot that’s already in the Snapshots List, click on the arrow to open the assignment drop-menu. A new snapshot



## Scope Page

Use the Scope page to select which racks and functions can be modified when a snapshot is recalled. All SuperRack settings are saved when a snapshot is stored. The Scope page filters which of these settings can change upon snapshot recall. The scope of a snapshot can be changed after the snapshot is created.

Scope selections are divided into two categories:

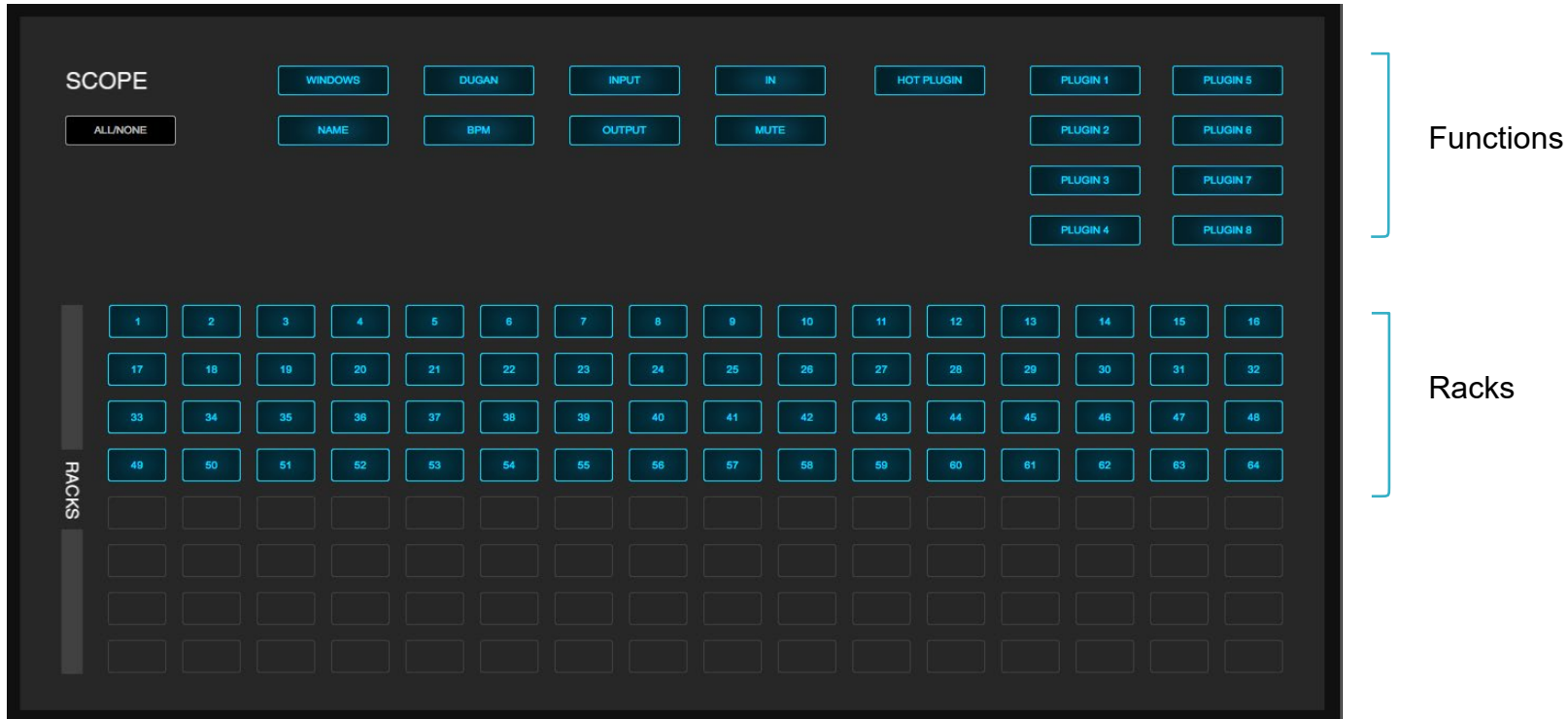

The screenshot displays the 'SCOPE' configuration page. At the top, there are two rows of function selection buttons. The first row includes 'WINDOWS', 'DUGAN', 'INPUT', 'IN', 'HOT PLUG IN', 'PLUGIN 1', and 'PLUGIN 5'. The second row includes 'ALL/NONE', 'NAME', 'BPM', 'OUTPUT', 'MUTE', 'PLUGIN 2', and 'PLUGIN 6'. Below these are two more rows of 'PLUGIN' buttons, labeled 'PLUGIN 3', 'PLUGIN 7', 'PLUGIN 4', and 'PLUGIN 8'. A large grid of 64 numbered buttons (1-64) represents the racks, arranged in four rows of 16. A vertical label 'RACKS' is positioned to the left of the grid. To the right of the interface, two blue brackets group the function buttons as 'Functions' and the rack buttons as 'Racks'.



## Scope Parameters

**Functions** can be assigned to the scope of any snapshot:

<b>Hot Plugins</b>	The contents of the Hot Plugins Panel (HPP) can be changed per snapshot. If Hot Plugins is selected, then when this snapshot loads, it will also read what plugins should be in the HPP and will load them accordingly. If the button is off, then the snapshot won't update the contents of the HPP.
<b>Windows</b>	Recalls which windows were open and how they were located on the screen when the snapshot was stored. This allows you to create a specific workspace for a snapshot.
<b>Name</b>	Change rack name.
<b>Dugan</b>	Dugan Speech settings. Current Dugan settings will be within the scope of the snapshot.
<b>BPM</b>	Change system BPM.
<b>Input</b>	Rack input level
<b>Output</b>	Rack output level
<b>In</b>	Sets rack processing to In (enabled) or Out (bypassed)
<b>Mute</b>	Mutes the rack
<b>Plugins</b>	These switches set whether a snapshot can change the parameters of any plugin in a specific plugin rack slot number, regardless of the plugin. When, for example, "Plugin 7" is deselected, all plugins in slot 7 <i>in any rack</i> are in recall safe mode when a snapshot is recalled.

**Racks** sets which racks are included in the scope of the snapshot. Scope parameters (e.g., Hot Plugins, Dugan, Mute) apply only to highlighted racks, so a rack that is not highlighted will not change with a snapshot recall, regardless of the Function settings. The number of racks in the Scope section reflects the current SuperRack configuration.

**All/None Select:** Resets the Scope selection to "all parameters/channels are within the scope of this snapshot" or "no parameters/channels are within the scope of this snapshot."



## Recall Safe Page

**Recall Safe** prevents changes to specified racks and functions during a snapshot change, regardless of Scope settings. Recall Safe is set for an entire session, not by snapshots. Once Recall Safe is set for the functions and racks of a session, snapshot recalls will not affect their settings. Racks and functions in recall safe mode are highlighted green.

The Recall Safe panel uses the same layout as the Snapshot page. As with the Scope page, there is an All/None button that selects and de-selects all parameters and channels.

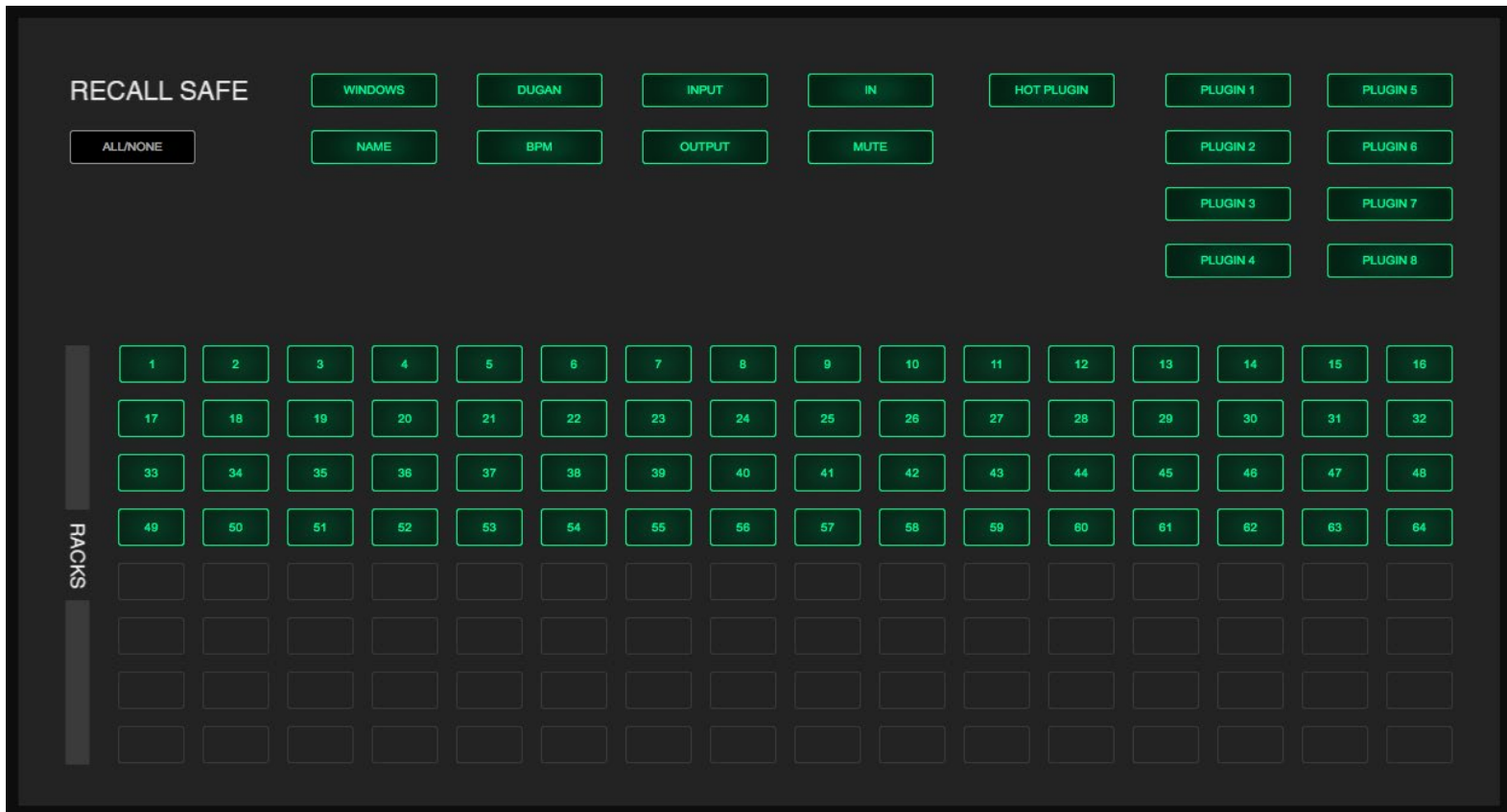

## RECALL SAFE FOR SPECIFIC PLUGINS

When you use the Recall Safe page to set a plugin *position* to Recall Safe, recall changes to *any* plugin in the specified position in *all* active racks will be recall safe.

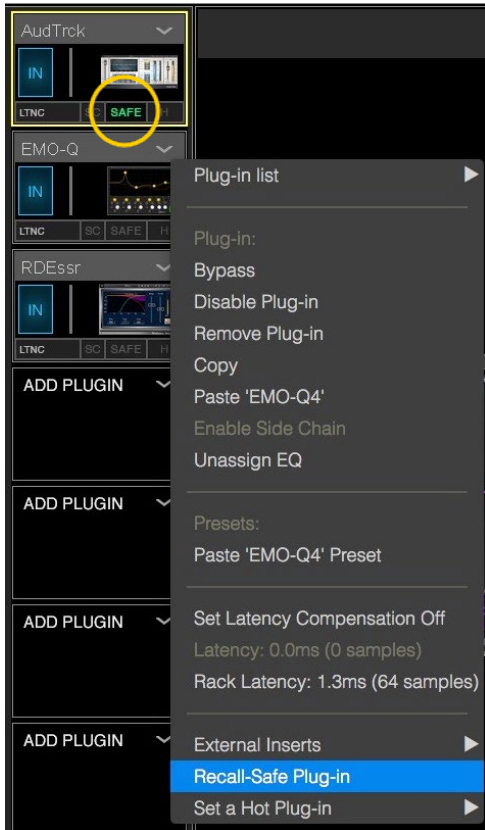

If you want to prevent a specific instance of a plugin from changing during a snapshot recall, use the Recall Safe *Plugin* menu item. This drop-down menu item is located at the bottom of the Plugin menu of the specified plugin.

There is a small indicator on the plugin icon that says “Safe.”

The Recall Safe status of the other plugins in the rack, as well as other plugins in the same position of other racks, are not affected by this setting.

## RACK RECALL SAFE

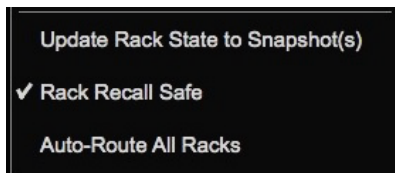

For convenience, a selected rack can also be set to Recall Safe from the Racks drop-down menu in the Top Bar. A small green SAFE indicates rack Recall Safe status.

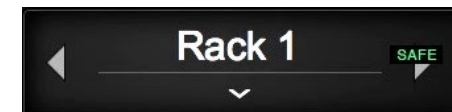

# Supplementary Material

## *Controlling SuperRack Remotely*

Many SuperRack functions can be controlled from one or two consoles or from any MIDI device:

- Load and save SuperRack session files from the console. When you select “load,” “open new,” or “save” on the console, SuperRack respectively loads, opens new, and saves files with the same names.
- Synchronize SuperRack snapshots with those on the console. When you store and recall snapshots from the console, corresponding snapshots are stored and recalled on SuperRack, keeping its snapshots in sync with the console’s snapshots.
- Touch and Turn a control. Assign one SuperRack control at a time to an external control. This puts the
- Use the MIDI Controller to map most SuperRack functions to an external device.

There are two types of remote control: **MIDI Controller** and **Console Remote Control**.

MIDI Controller	Maps most commonly used SuperRack controls, including plugins.
Console Remote Control	Synchronizes scenes and snapshots between a console and SuperRack. In this mode, only the console can control these functions.





## Assigning Controls

All Controllers are assigned in the Inventory page of the Setup Window

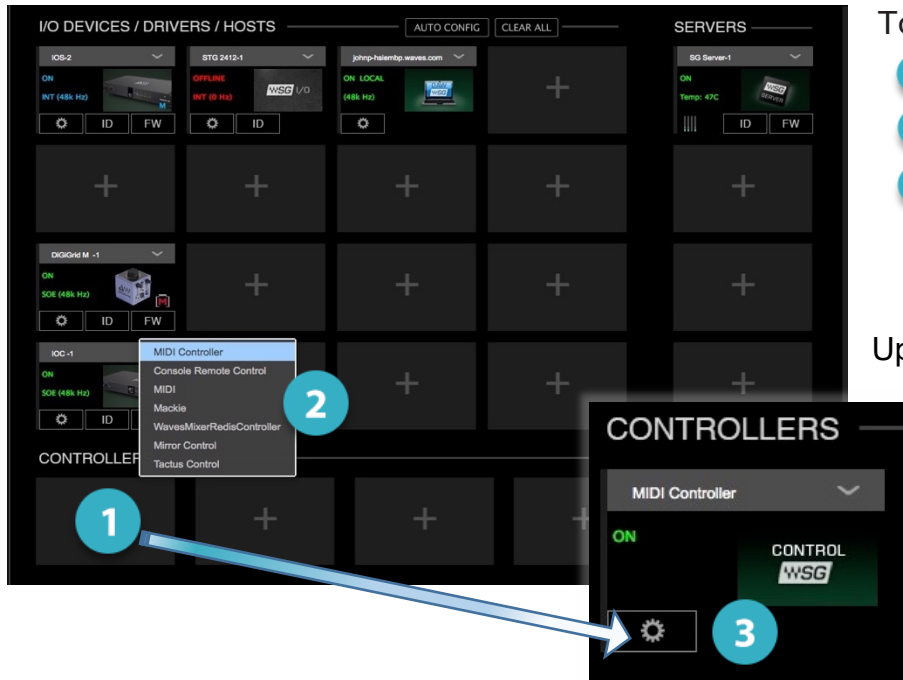

To add a controller:

- 1 Click on an empty controller slot.
- 2 Select a controller from the drop-down menu.
- 3 Click the controller's "Gear" button to access its control panel.

Up to five controllers can be assigned.



## MIDI CONTROLLER

Use the MIDI Controller to map between hardware MIDI controllers and numerous SuperRack functions. Its interface displays SuperRack functions that can be controlled directly via MIDI, including the eight continuous and eight discrete plugin controls. Assign links to SuperRack controls using a standard “MIDI Learn” routine.

1. Open the MIDI Controller.
2. Select the SuperRack function you wish to control.
3. Move the desired knob or press the desired button on your MIDI controller to establish an assignment.



The MIDI Controller interface displays SuperRack functions that can be assigned to a MIDI controller.

<b>1</b>	<b>General Settings</b>	<b>Global MIDI Settings</b> Select input MIDI device input and MIDI THRU. <i>MIDI Takeover</i> : Actions on the remote controller will not affect the corresponding SuperRack control until their values match.
----------	-------------------------	---



	<p>Enable 14-bit CC Support: Allows SuperRack to handle 14-bit MIDI CC (control change message) data. Certain consoles send out 14-bit MIDI data; un-checking this sets SuperRack to handle 7-bit MIDI CC.</p> <p><i>Display MTC:</i> When selected, the clock window in the Top Bar displays MIDI timecode. When deselected, the window displays time from the host computer.</p>
2	<p><b>Snapshot Recall</b> Establishes how MIDI controls snapshot recalls.</p> <p><i>Follow Program Changes on Channel</i> drop-down menu: selects the MIDI channel on which SuperRack will respond to program change messages. Program change messages on other MIDI channels will be ignored.</p> <p><i>Use Control Change Messages:</i> snapshot recalls for snapshots whose indexes are higher than 128 can be done by mapping snapshot ranges (128–255, 256–384, etc.) to MIDI CCs.</p>
3	<p><b>Navigation</b> Assign navigation between racks and between plugins.</p> <p><i>Prev Rack</i> and <i>Next Rack</i> moves rack selection up and down. Select <i>Open Rack</i> to view it in its Rack Window. <i>Overview</i> opens the Overview window at the layer that contains the currently selected rack.</p> <p><i>Prev Plugin</i> and <i>Next Plugin</i> move up and down the plugin chainer of the selected rack and opens the plugin's control pane.</p>
4	<p><b>Rack Controls</b> Maps MIDI control messages to control the rack's input gain, output gain, in/out state, and mute on/off.</p>
5	<p><b>File</b> <i>Import</i> and <i>Export</i> control enable you to save the settings you've made in the MIDI controller panel and export them to another panel.</p>
9	<p><b>User Keys</b> Maps the 16 user-assignable keys that are defined in the Settings page.</p>
11	<p><b>Plugin Controls</b> This panel maps plugin settings control for the selected plugin.</p> <p>You can map 8 continuous controls and 8 discrete switches per page.</p> <p><i>Next Page/Previous Page</i> navigate between plugin control pages.</p> <p>See below to learn more about controlling plugins with MIDI.</p>
8	<p><b>Snapshots</b> Maps eight hot snapshots for direct recall via MIDI.</p> <p><i>Next/Prev</i> maps recalling the next or previous snapshot.</p>



9

Tempo

Maps the Tap Tempo button (Top Bar).

10

Hot Plugins

Maps any of the 12 Hot Plugin assignments to a control.

## PLUGIN MIDI MAPPING

The Plugin Controls panel is used to assign external control of the currently selected plugin or the plugin that's focused in the plugin pane. This mapping applies also to plugins in detached panels. Plugin controls are mapped to all Waves plugins with the ProControl AFAIK-supported page table, controlling groups of eight variable and eight discrete plugin parameters at a time. Use the Next/Prev buttons to move between pages.



A SuperRack Session can have up to 64 racks, each containing up to eight plugins. Since every plugin has several parameter controls, remote control of so many different variables could be a complex task and would require you to re-map MIDI links each time the configuration changes. MIDI mapping is simplified in SuperRack by using a matrix that sits between the plugin and the MIDI controller. This matrix assigns key parameter control knobs and buttons to fixed matrix positions so that MIDI assignments always make sense, regardless of type of processor. For example, when dynamics processors are being used, the matrix usually assigns the first position to Threshold, the second to Ratio, the third to Attack, and so forth. With EQ processors, the first variable position is usually Input Gain, followed by Band One Gain, Band One Frequency, etc. Plugin controls that are currently under MIDI control are outlined in red, as shown below.



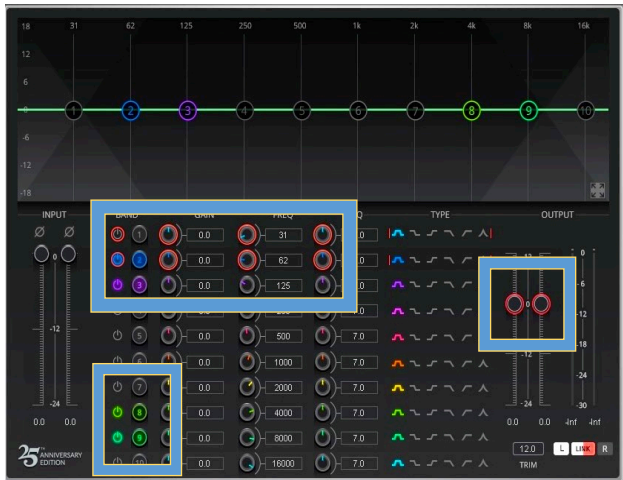

Q10 and Renaissance Equalizers share the same mapping on the current page.



Similarly, TrueVerb and RVerb share the same mapping on the current page.

The relationship between hardware and software needs to be set only once. The specific parameter control will change with each type of plugin, but the logic will remain consistent within categories (e.g. EQs, Dynamics) of Waves plugins.



## CONSOLE REMOTE CONTROL

You can synchronize SuperRack with many mixing consoles. This moves handling of sessions and snapshots to the console, which lets you keep your eyes and hands on the console. You can also control one plugin at a time using Touch and Turn. Setup is done in the Remote Control Surface Option panel:

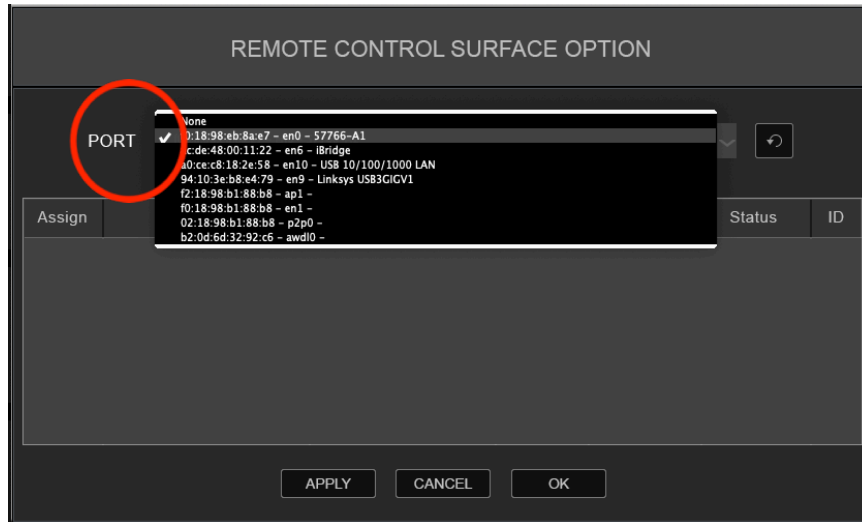

1. Assign “Console Remote Control” to a Controller slot in the Inventory page. Click on the Gear icon to open the Remote Control Surface Option.
2. Select the host computer’s LAN port that connects to the network. If the remote console is on the SoundGrid network, then use the same LAN port as SoundGrid. If it's on another network, select the LAN port that's connected to that network.

Some consoles have a second LAN port. You can use this port to create an additional network for remote control. Imagine a broadcast plant with its own network that includes several consoles that are spread throughout the building. This network facilitates exchange of files and other data. In many situations, it’s not desirable for an audio network—which is mission-critical and usually uses a lot of bandwidth—to be the same network that serves the plant. Two networks are needed: the SoundGrid network for SoundGrid traffic only, and the other network for remote control.

3. Connect an Ethernet cable between the second LAN port on the console (if available) and the SoundGrid switch. Select this LAN port in the Remote Control Surface Option panel.



When a LAN port is assigned, you will see a list of all available consoles.

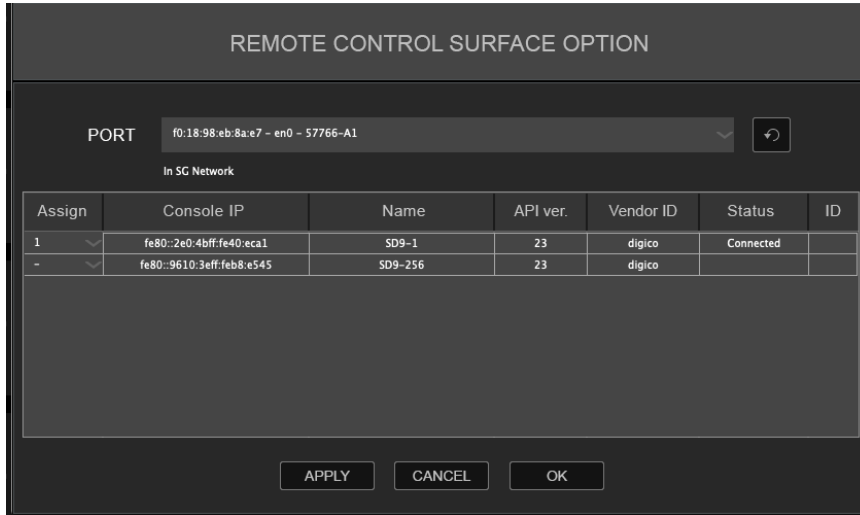

4. Select the appropriate console. The console and the SuperRack are now synchronized. Session and snapshot handling are now under exclusive control of the console and are deactivated in SuperRack.

Session files are saved to a folder that SuperRack searches when Remote Control is active. If you are copying sessions from one machine to another, make sure to look for the session files in this location. SuperRack SoundGrid and SuperRack have their own dedicated folders:

- Mac: /Users/Shared/Waves/SuperRack SoundGrid/Integrated Sessions/  
/Users/Shared/Waves/SuperRack/Integrated Sessions/
- PC: C:\Users\Public\Waves Audio\SuperRack SoundGrid\Integrated Sessions\  
C:\Users\Public\Waves Audio\SuperRack\Integrated Sessions\

## TOUCH AND TURN

Select a plugin parameter on the SuperRack interface and change its values through the console's dedicated control. More functions are available, depending on the console's implementation.



## Console Mirroring:

Two DiGiCo consoles can be mirrored to provide full redundancy. In the event of a console or SuperRack failure, control and processing will pass to the redundant DiGiCo/SuperRack system. Switching between main and redundant consoles or engines is automatic and is handled by the console. The SuperRack associated with the redundant console will replace the original SuperRack.

Console mirroring requires two complete DiGiCo /SuperRack SoundGrid networks, each with the same, most current software versions.

### SETTING UP MIRRORING

The Mirroring Control Option control panel shows compatible consoles that are available to this console.

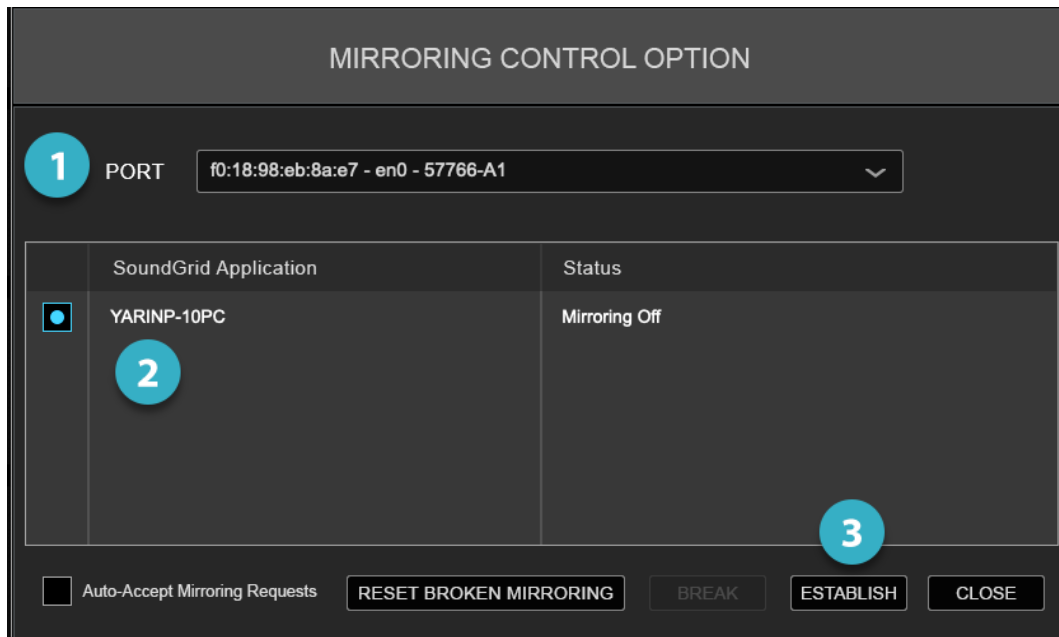

- 1 Select the LAN port that this host computer is using to connect to the SoundGrid network. A list of the SoundGrid applications that can be mirrored to this console is shown on the left.
- 2 Select the desired console from list.
- 3 Click **Establish** to start mirroring.





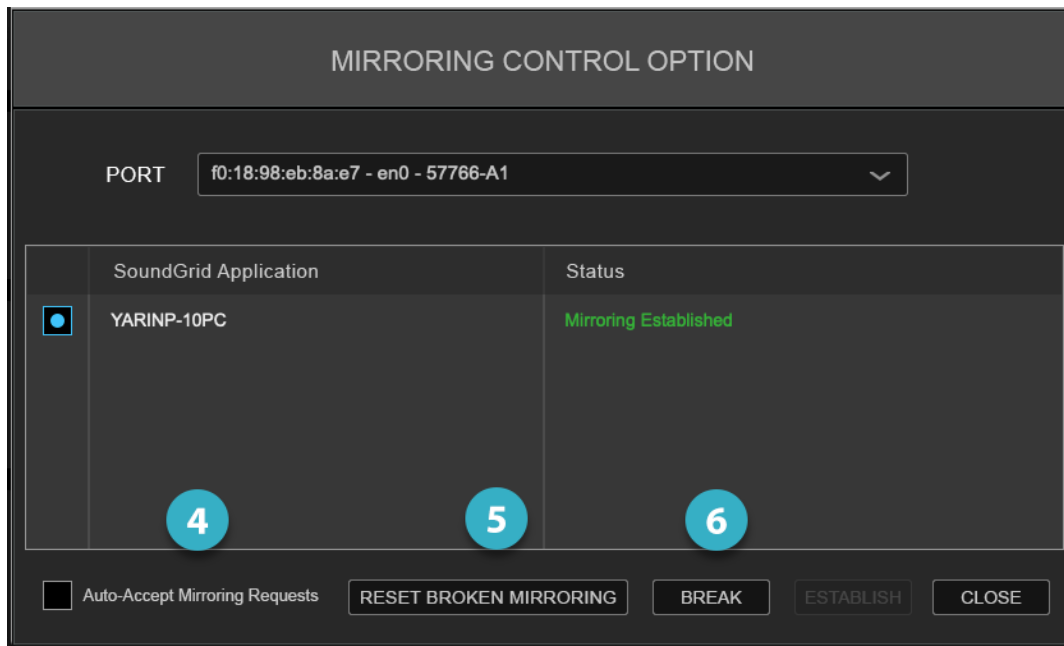

- 4 When **Auto-Accept Mirroring Requests** is selected, the console automatically accepts requests for mirroring. When this is not selected, the recipient console can accept or reject mirroring requests manually.
- 5 Use **Reset Broken Mirroring** when mirroring communication has been lost.
- 6 **Break** stops communication used for mirroring.

Refer to the user guide for your DiGiCo console to learn more about setting up Console Mirroring.



## Keyboard Shortcuts and Modifiers

Function	Window	Keystroke	Action
Reset	All	Alt+click on a control	Returns most controls to default value. This is also true with most plugin controls.
Insert to all racks	Overview	Alt + right click/insert a plugin	The selected plugin is inserted in the same rack insert position on all channels in the layer.
Bypass on all racks	Overview	Alt + right click/bypass a plugin	Bypasses all plugins in the same rack insert position on all channels in the layer. This affects the chosen rack position, regardless of the plugin type.
Disable on all racks	Overview	Alt + right click/disable a plugin	Disables all plugins in the same rack insert position on all channels in the layer. This affects the chosen rack position, regardless of the plugin type.
Remove from all racks	Overview	Alt+ right click/remove a plugin	Removes all plugins in the same rack insert position on all channels in the layer. This affects the chosen rack position, regardless of the plugin type.
Disable plugin	Rack / Overview	Ctrl+click on plugin icon	Disables one plugin.
Bypass plugin	Rack / Overview	Ctrl+alt+click on plugin	Bypasses one plugin.
Move plugin to another rack	Overview	Drag plugin from one rack to another	Moves the plugin and its presets to another rack.
Copy plugin to another rack	Overview	Alt+drag plugin from one rack to another	Copies the plugin and its presets to another rack.
Remove plugin	Rack / Overview	Swipe plugin icon off of the screen	Removes a plugin from the rack.
Save	All	Cmd]/Ctrl + S	Saves the current session.

