

MKE 600

Microphone for
Video Journalists



Bedienungsanleitung
Instruction manual
Notice d'emploi
Istruzioni per l'uso
Instrucciones de uso
Manual de instruções
Gebruiksaanwijzing
Руководство по эксплуатации
使用说明

Important safety information

- Please read this instruction manual carefully and completely before using the product.
- Make this instruction manual easily accessible to all users at all times. Always include this instruction manual when passing the product on to third parties.
- This instruction manual is also available on the Internet at www.sennheiser.com.

Before operation

- Never open the housing of the product. If products are opened by customers in breach of this instruction, the warranty becomes null and void.

During operation

- Keep all liquids away from the product. Liquids entering the product can short-circuit the electronics or damage the mechanics.
- Only use a soft, dry cloth to clean the product. Solvents or cleansing agents can damage the surface of the product.
- Only use the product within the specified temperature range (see "Specifications" on page 5).

After operation

- Use the product with care and store it in a clean, dust-free environment.

Intended use

Intended use includes:

- having read this instruction manual, especially the chapter "Important safety information",
- using the product within the operating conditions and limitations described in this instruction manual.

"Improper use" means using the product other than as described in this instruction manual, or under operating conditions which differ from those described herein.

Delivery includes

- 1 MKE 600 gun microphone
- 1 MZS 600 shock mount
- 1 MZW 600 foam windshield
- 1 instruction manual
- 1 carry case

Optional accessories

- MZQ 600 microphone clamp
- MZH 600 "hairy" windshield
- KA 600 connection cable for cameras with 3.5 mm jack connection

For information on suppliers, contact your local Sennheiser partner: www.sennheiser.com > "Service & Support".

The MKE 600 gun microphone

The MKE 600 is the ideal video camera/camcorder microphone able to handle even demanding filmic challenges. Due to its high directivity, the MKE 600 picks up sounds coming from the direction in which the camera is pointing and effectively attenuates noise coming from the sides and rear. The switchable "Low Cut" filter additionally minimizes wind noise.

Because some video cameras/camcorders do not provide phantom power, the MKE 600 can also be battery powered. A battery on/off switch prevents the battery from discharging prematurely; "Low Batt" is displayed.

Features

- Pronounced directivity
- Maximal rejection of side noise
- Switchable "Low Cut" filter minimizes wind noise
- Phantom or battery powering
- Battery switch with "Low Batt" indicator
- Rugged all-metal housing
- Very good suppression of structure-borne noise
- Supplied with foam windshield and shock mount

Product overview

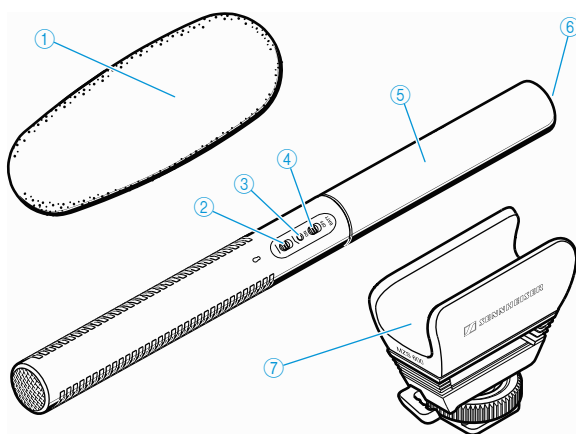

- ① Foam windshield attenuates wind noise by approx. 25 dB
- ② "Low Cut" switch — / —
- ③ LED operation indicator
- ④ BATT ON/OFF battery switch
- ⑤ Lower part of the microphone body (covers the battery compartment)
- ⑥ XLR-3 socket (male)
- ⑦ Shock mount with flash mount adapter

Putting the MKE 600 into operation

The MKE 600 offers a choice of phantom powering via the XLR connection or internal battery powering.

P48 phantom powering via XLR connection

- ▶ Connect the XLR-3 socket (female) of the microphone cable to the XLR-3 socket (male) of the microphone ⑥.
- ▶ Connect the connector of the microphone cable to the video camera/camcorder or recording device.
The LED ③ provides the following information:

LED	P48 phantom powering
lights up green	switched on; the microphone is operational

i If phantom powered via the XLR connection, the microphone is continuously in operation (the **BATT ON/OFF** battery switch has no function).

Internal battery powering

- ▶ Unscrew the lower part of the microphone body ⑤ by turning it in the direction of the arrow.
- ▶ Insert a battery/rechargeable battery (AA size, 1.5 V/1.2 V). Observe correct polarity when inserting the battery.
- ▶ Screw the lower part of the microphone body ⑤ back to the microphone by turning it in the direction of the arrow.

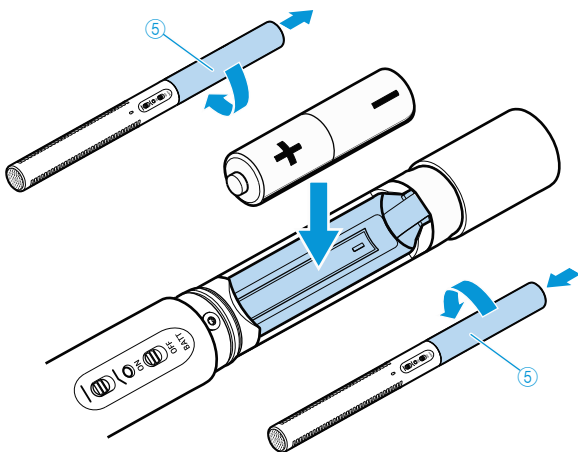

- ▶ Set the battery switch ④ to **ON** to switch the internal battery on or set the battery switch to **OFF** to switch the battery power off.

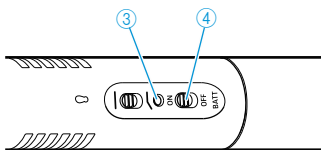

The LED ③ provides the following information:

LED	Internal battery power
lights up red for approx. 1 second after switch-on and then goes off	switched on; operating time: up to approx. 150 h
lights up red permanently	“Low Batt”, battery is almost empty; approx. 8 h of remaining operating time after initial display
flashes briefly red on switch-on	battery is empty; the microphone is not operational

i When not using the microphone for extended periods of time, remove the battery to prevent self-discharge.

Using the “Low Cut” filter

- ▶ Set the “Low Cut” switch ② to the desired position.

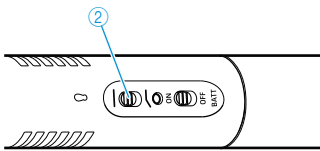

Switch position	Frequency response of the microphone
—	linear frequency response
⤴	frequencies below 100 Hz are attenuated to reduce wind and impact noise

Cleaning and maintaining the MKE 600

CAUTION

Damage to the product due to liquids!

Liquids entering the product can short-circuit the electronics or damage the mechanics. Solvents or cleansing agents can damage the surface of the product.

- ▶ Keep all liquids away from the product.
- ▶ Only use a soft, dry cloth to clean the product.

Specifications

Pick-up pattern	super-cardioid/lobar
Frequency response	40 Hz to 20 kHz
Sensitivity	with P48 powering: 21 mV/Pa with battery powering: 19 mV/Pa
Max. SPL	with P48 powering: 132 dB SPL with battery powering: 126 dB SPL
Equivalent noise level A-weighted	with P48 powering: 15 dB (A) with battery powering: 16 dB (A)
Power supply	48 V ± 4 V (P48, IEC 61938) via XLR-3 or battery/rechargeable battery (AA size, 1.5 V/1.2 V)
Current consumption	with P48 powering: 4.4 mA
Operating time with battery	approx. 150 h
"Low Batt" indicator	< 1.05 V; approx. 8 h of remaining oper- ating time after initial display
Diameter	20 mm
Length	256 mm
Weight	128 g (without battery)
Operating temperature	-10°C to +60°C

Polar diagram

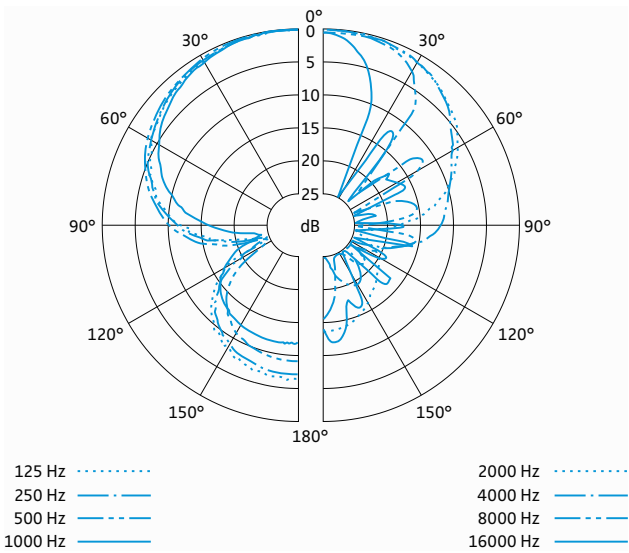

Frequency response curve

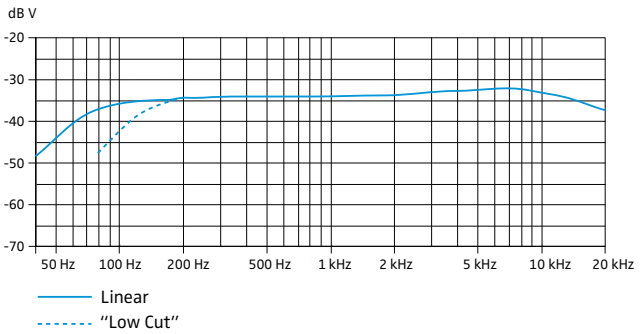

Manufacturer Declarations

Warranty

Sennheiser electronic GmbH & Co. KG gives a warranty of 24 months on this product.

For the current warranty conditions, please visit our website at www.sennheiser.com or contact your Sennheiser partner.

In compliance with the following requirements

- RoHS Directive (2002/95/EC)
- WEEE Directive (2002/96/EC)





Please dispose of this product by taking it to your local collection point or recycling center for such equipment.

CE Declaration of Conformity

- EMC Directive (2004/108/EC)

The declaration is available at www.sennheiser.com.

In compliance with

Europe	 EMC EN 55103-1/-2
USA	FCC 47 CFR 15 subpart B
Canada	Industry Canada ICES-003
China	
Australia/ New Zealand	 N340

FCC and Industry Canada Warning Statement

This device complies with Part 15 of the FCC rules and RSS210 of the Industry Canada Rules.

Operation is subjected to the following two conditions:

- 1) This device may not cause harmful interference, and
- 2) This device must accept any interference received, including interference that may cause undesired operation.



Sennheiser electronic GmbH & Co. KG

Am Labor 1, 30900 Wedemark, Germany
www.sennheiser.com

Printed in Germany, Publ. 06/12, 536956/A01