



AcousticPerformance™ Series

AP-5152

High power, installation
loudspeaker

Features

- DMT™ (Directivity Matched Transition) ensures smooth, coherent power response across the listening plane
- 75 degree coverage of the axisymmetric waveguide matches natural coverage of the 15-inch woofer at the crossover point for consistent power response
- 3-inch voice coil compression driver for outstanding high-frequency performance
- M10 fittings offer flexible deployment options for a variety of applications
- Covered barrier strip terminals and NL4 Speakon™ connector
- Bi-Amp / Passive switchable
- 15-ply Baltic birch plywood construction
- 16-Gauge powder coated steel grilles
- Clean industrial design with unadorned grilles compliment most decors and settings
- Available in black (RAL 9011) and white (RAL 9010)
- Complete EASE, CAD & BIM information available at qsc.com



Performance Spaces · Worship Facilities · Dance/Night Clubs · Sports Facilities · Themed Entertainment

The QSC AcousticPerformance™ AP-5152 is a professional, two-way, full-range loudspeaker ideal for a variety of installed sound reinforcement applications requiring higher SPL output and a clean appearance. The AP-5152 uses a high power-capacity, 76mm (3-inch) diaphragm compression driver and combines it with a 381mm (15-inch) woofer to deliver exceptional full bandwidth reproduction.

The uniform power-response of the AP-5152 loudspeaker is a result of DMT™ (Directivity Matched Transition), a design approach that matches LF and HF coverage in the cross-over region. Another key to the extraordinary accuracy and flat power response of the AP-5152 is the axisymmetric waveguide with uncompromised performance in both the vertical and horizontal axes. The result is remarkably consistent coverage and smooth, accurate reproduction on and off-axis.

The AP-5152 may be used as a passive (full-range) loudspeaker to minimize amplifier channel count or it may be bi-amplified for greater control and performance. To further enhance performance, bi-amp and full-range tunings using QSC Intrinsic Correction techniques are available for Q-Sys and future QSC products.

The AP-5152 enclosure features M10 mounting points for suspension via eyebolts.

Presenting a clean, unobtrusive look, AcousticPerformance grilles are unadorned eliminating the need to cover-up logo treatments which can be difficult to hide or remove. The grille is also lined with acoustically transparent backing adding to the enclosure's professional appearance and the AP-5152 is available in black (RAL 9011) and white (RAL 9010) finishes.

To minimize impact and disposal fees at the job site, all AcousticPerformance loudspeakers are packaged in environmentally friendly, recyclable cartons.

AP-5152 Details

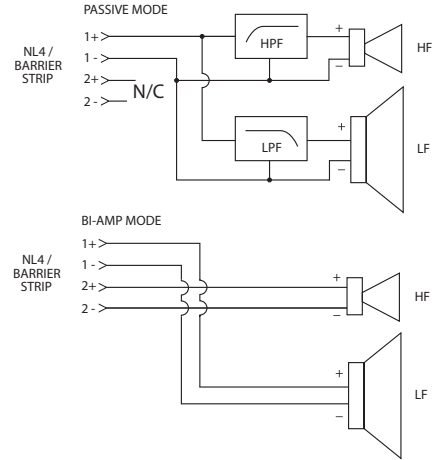
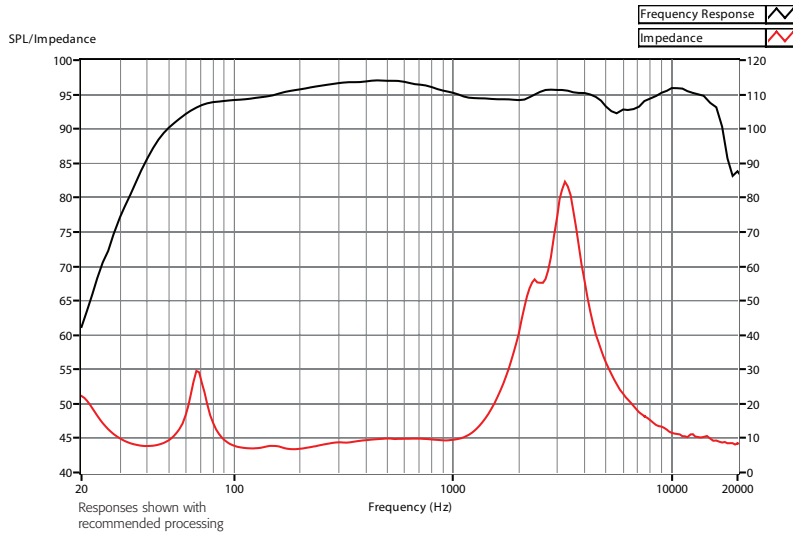
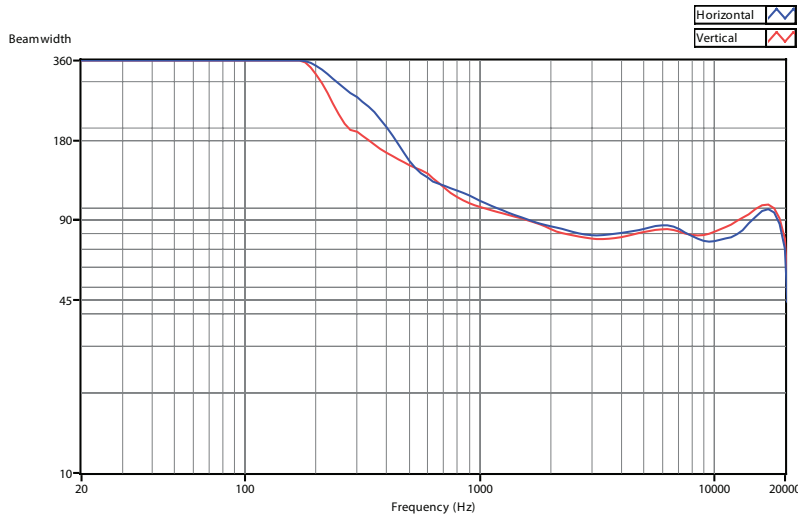

Specifications:

System Details

Frequency Response (-10dB)	44Hz – 18kHz
Power Capacity ¹	625W / 65V continuous
System Sensitivity ²	96dB, 1W@1m
Coverage Angle	75° Axisymmetric
Directivity Factor (Q)	8.3
Directivity Index (DI)	9.2
Recommended Crossover	950 Hz, 48dB/octave
Maximum Rated SPL	Passive: 123dB @1m, continuous ³ 129dB @1m, peak ⁴
Rated Impedance	8Ω
HF Transducer	76mm (3-inch) voice coil, compression driver; 72W / 24V (2 Hrs)
LF Transducer	381mm (15-inch) driver with 102mm (4-inch) VC; 625W / 65V (2 Hrs)
Optional Accessories	M10 Kit-W

Enclosure Details

Input Connector	Covered Barrier Strip, NL4 connector
Enclosure Material	15-ply Baltic birch plywood
Attachment Points	15x M10 threaded inserts
Color	Black (RAL 9011), White (RAL 9010)
Grille	16 Gauge powder coated steel
Dimensions (HxWxD)	813mm x 445mm x 386mm (32" x 17.5" x 15.2")
Net Weight	36.2 kg (80 lb)
Shipping Carton Dimensions (HxWxD)	857mm x 560mm x 503mm (33.8x22x20-inches)
Shipping Weight	40.8kg (90 lbs)

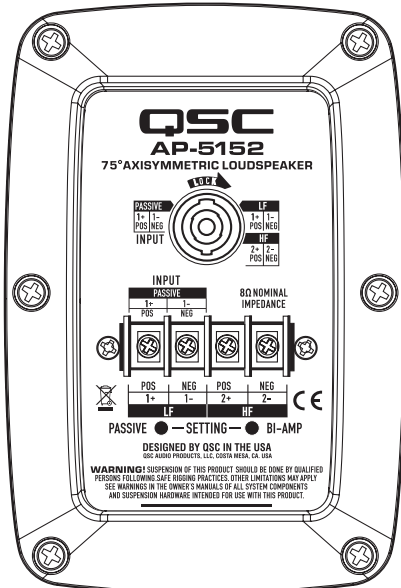

As part of QSC's ongoing commitment to product development, specifications are subject to change without notice.

¹ 2 hour rating using IEC60268 noise based on minimum impedance

² Mid-band based on nominal impedance

³ Calculated as the nominal sensitivity plus 10x the log of continuous rated power in volts squared divided by nominal impedance

⁴ Calculated as the continuous calculated max output plus 6dB

AP-5152 Horizontal Polars

Polar Plot

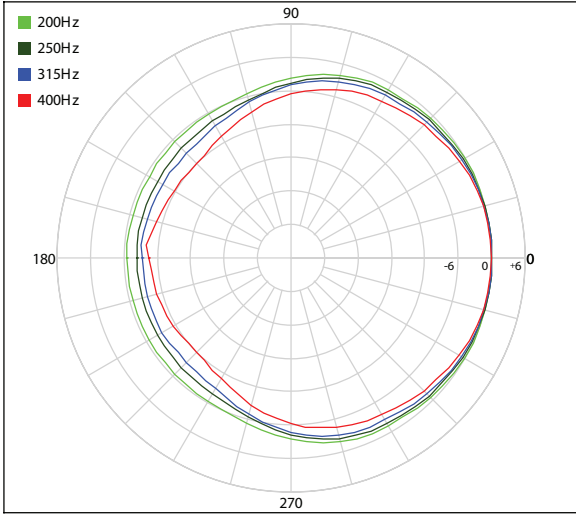

Polar Plot

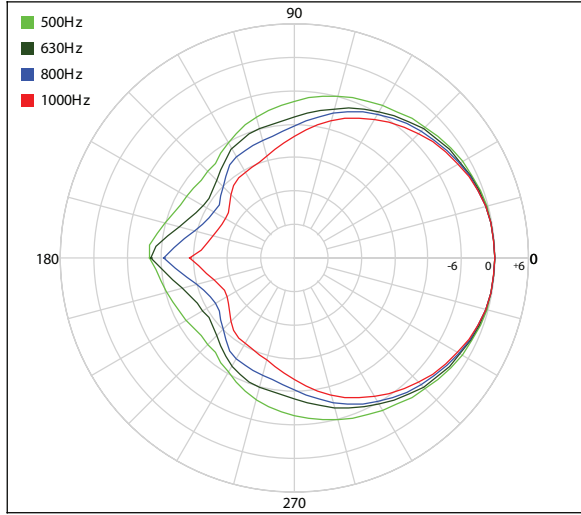

Polar Plot

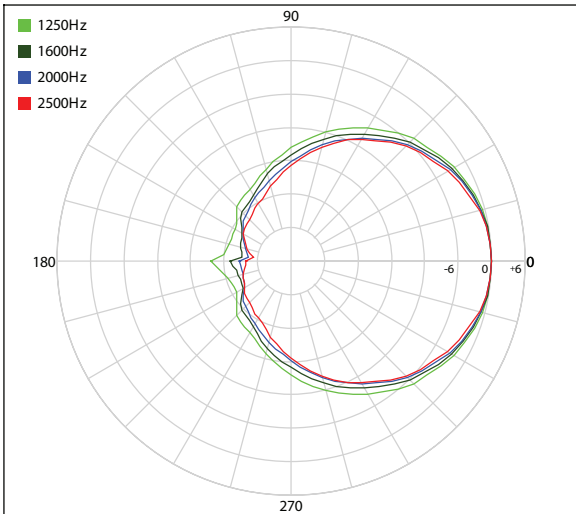

Polar Plot

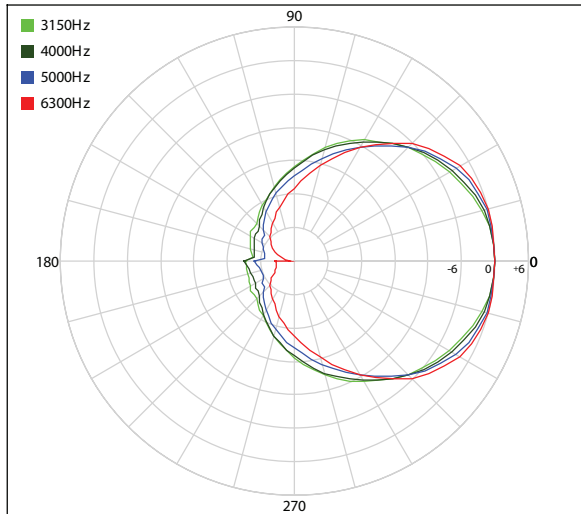

Polar Plot

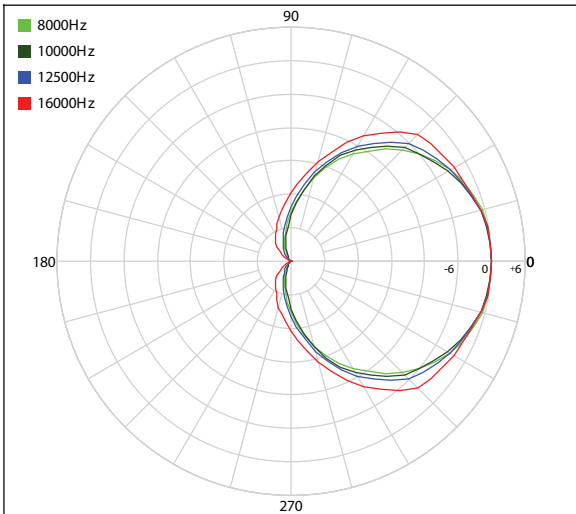

AP-5152 Vertical Polars

Polar Plot

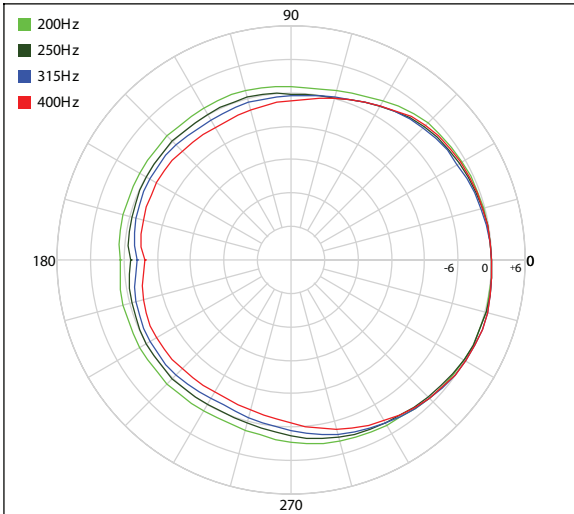

Polar Plot

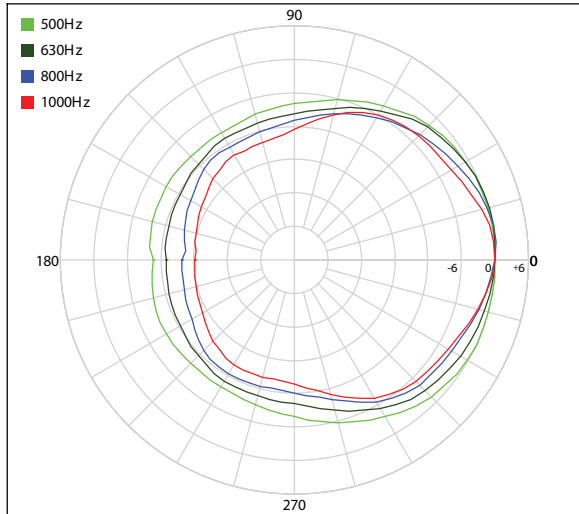

Polar Plot

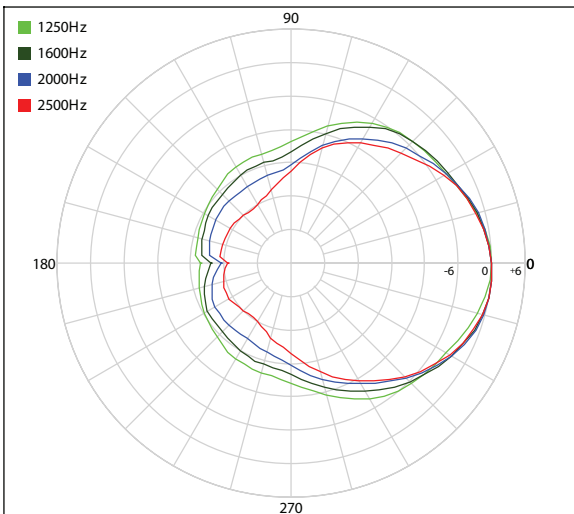

Polar Plot

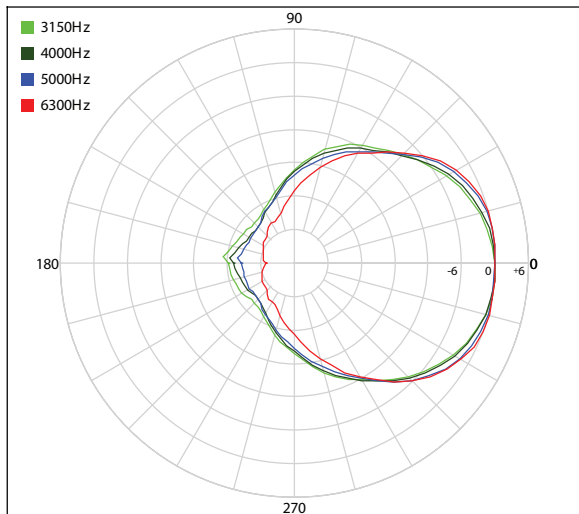

Polar Plot

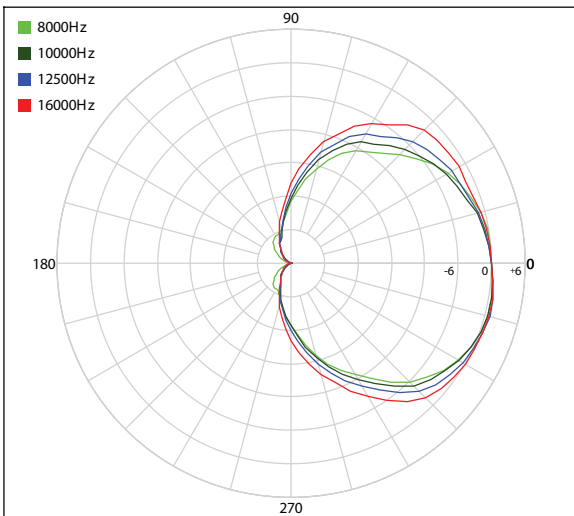

AP-5152 Technical Drawings

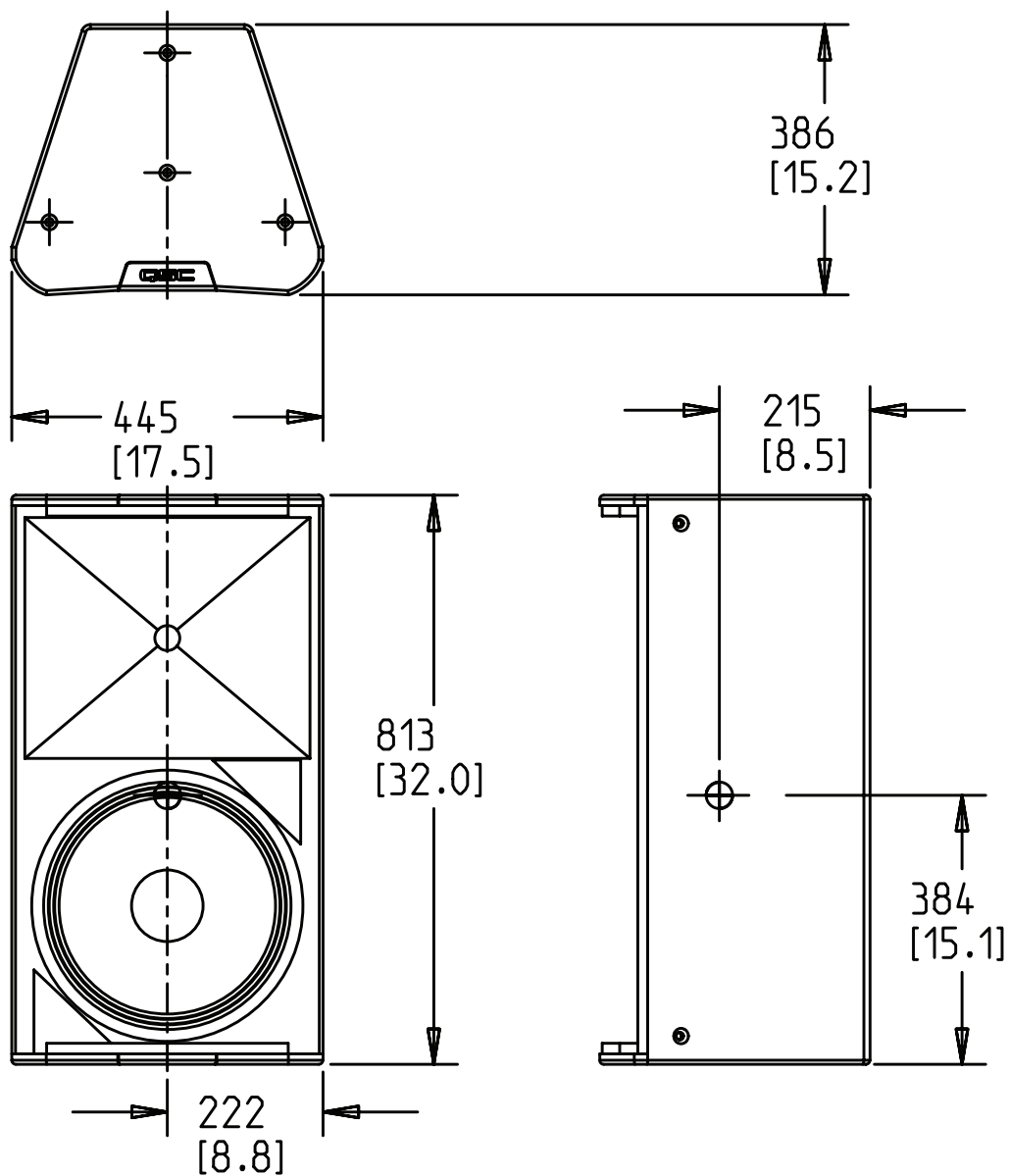

⊕ INDICATES CENTER OF BALANCE.

QSC™

1675 MacArthur Boulevard • Costa Mesa, CA 92626 • Ph: 800/854-4079 or 714/957-7100 • Fax: 714/754-6174



please recycle

© 2012 QSC Audio Products, LLC. All rights reserved. QSC and the QSC logo are registered trademarks of QSC Audio Products, LLC in the U.S. Patent and Trademark office and other countries. DMT is a trademark of QSC. Speakon is a registered trademark of Neutrik

AP-5152 Spec Sheet 12/12/2012

CCI Solutions
be seen. be heard.®
Call for The Best Available Price!
800-562-6006