

StudioLive™ Series III

StudioLive Series III MCU Emulation for Logic DAW Control Addendum

MCU



Table of Contents

1 Introduction — 1

2 Getting Started — 1

2.1 Controlling your DAW — 2

2.1.1 Enabling Mackie Control Emulation — 2

2.1.2 Making the Connections — 3

2.1.3 Setting up your Mixer in Logic — 4

3 Controls — 6

3.1 Control Screen — 6

3.2 Fat Channel Controls — 7

3.3 Encoder and Buttons — 8

3.4 Fader Banks — 8

3.5 Transport and Navigation — 9

3.6 Modifiers — 10

3.7 Global View — 11

3.8 User Functions — 12

1 Introduction

Your StudioLive Series III console mixer can be used as a hardware controller for any DAW application that supports Mackie Control. Once enabled, your StudioLive Series III console will emulate many Mackie Control functions.

We suggest that you use this addendum to familiarize yourself with the features, applications, and correct connection procedures for your StudioLive mixer before trying to connect it to your computer to control your favorite DAW application. This will help you avoid problems during installation and setup.

This guide will provide instructions on enabling Mackie Control Emulation mode for DAW Control as well as how the Mackie Control functions are mapped to your StudioLive Series III console mixer. For information on enabling a Mackie Control emulation device in your DAW, please consult the manufacturer's reference guide.

Note: HUI and MCU control emulation modes require Universal Control 2.10 or later installed on your computer and firmware version 1.10 or later installed on your StudioLive Series III mixer.

2 Getting Started

To begin using your StudioLive Series III mixer as a Mackie Control Emulation device, connect it to an available Ethernet port on the same router to which your computer is connected (wired or wirelessly) or directly to an Ethernet connection on your computer.

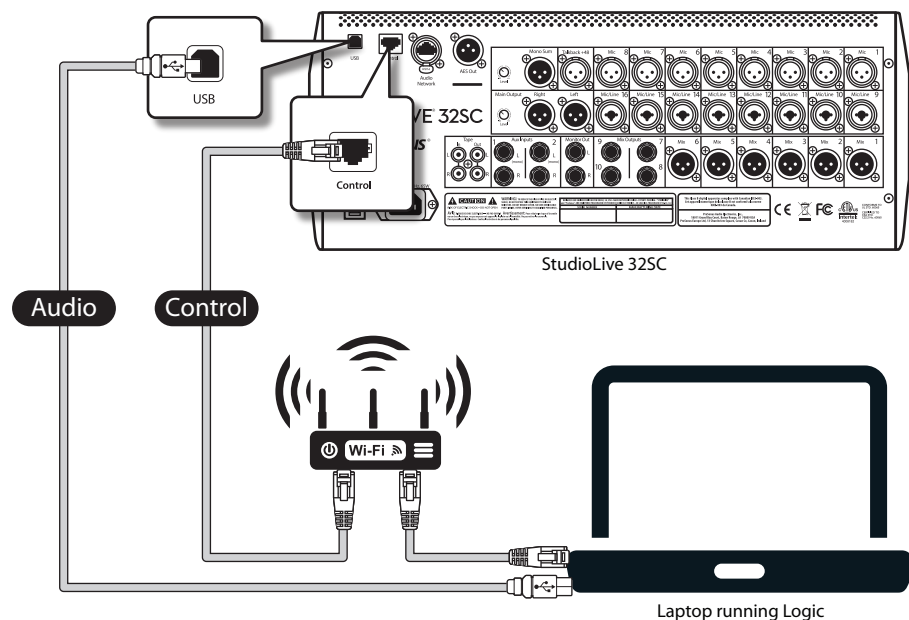

Please Note: At the time of publication, remote control over USB is not supported. You must network your mixer and your computer to use DAW mode, in addition to connecting USB for audio transport so that your StudioLive can be used as an audio interface.

Important: If you are hardwiring your computer to the same router as your mixer, you must disable the wireless connection on your computer. UCNET does not support dual network connections.

Note: Ethernet-to-Thunderbolt and Ethernet-to-USBC adapters are also supported. Ethernet-to-USB adapters will not allow your computer to network to a StudioLive mixer.

2.1 Controlling your DAW

2.1.1 Enabling Mackie Control Emulation



1. Launch Universal Control on the computer that is networked to your StudioLive mixer.
2. Go to Settings | Preferences.

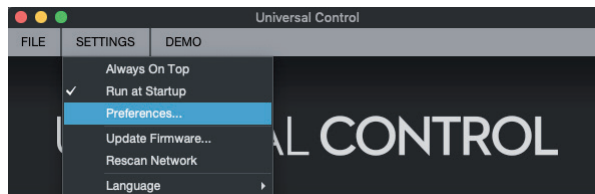

3. Click on the Network MIDI tab.
4. Check the box next to your mixer.

Note: It may take up to a minute for your mixer's IP address to register. A green indicator will appear once your mixer's Network MIDI ports are available.

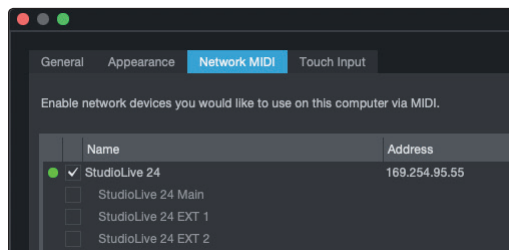

5. Click Apply and then OK to close the Preferences window.
6. Press the UCNET button on your StudioLive mixer.

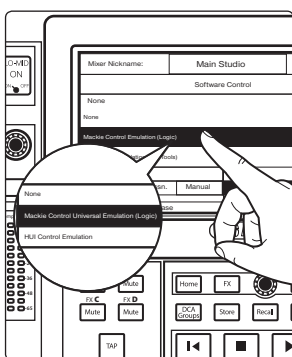
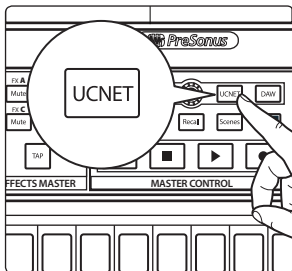

7. Tap on the Software Control drop-down menu on the Touchscreen and select Mackie Control Universal Emulation (Logic) from the drop-down list.

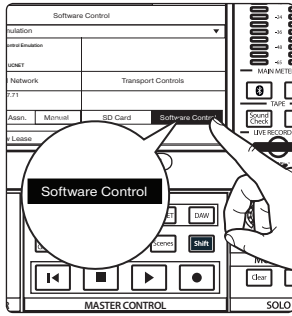

- If you would like the Transport Controls on your StudioLive to control your DAW, select “Software Control.” If you would like the Transport Controls on your StudioLive to control the SD recorder on your mixer, select “SD Card.”

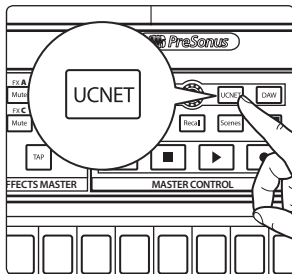

- Press the UCNET button again to exit the setup screen.

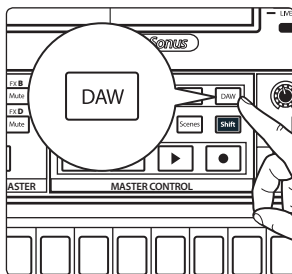

- Tap the DAW button your mixer to engage DAW control mode.

Power User Tip: DAW mode can be toggled on and off at will, allowing you to control your mixer’s DSP engine and switch back to controlling your DAW with the touch of a button.

IMPORTANT: Your StudioLive mixer sends Mackie Control Emulation information using MIDI-Over-Ethernet. Universal Control must be open and your mixer’s network MIDI ports must be enabled for your StudioLive to show up as a control device in your DAW.

2.1.2 Making the Connections

Once you have networked your mixer and your computer, the next step is to launch your DAW and configure your mixer as follows:

- StudioLive 64S, 32S, or 32:** (1) Mackie Control Universal and (3) Mackie Control Extenders
- StudioLive 32SX or 24:** (1) Mackie Control Universal and (2) Mackie Control Extenders
- StudioLive 32SC or 16:** (1) Mackie Control Universal and (1) Mackie Control Extender

Because Mackie Control Universal is an 8-fader protocol, your StudioLive mixer will present multiple MIDI ports, allowing you access to every fader.

32-fader Models	Device Type	24-fader Models	Device Type	16-fader Models	Device Type
PreSonus [SL64S, SL32S, or 32] Main	Mackie Control Universal	PreSonus [SL32SX or 24] Main	Mackie Control Universal	PreSonus [SL32SC or 16] Main	Mackie Control Universal
PreSonus [SL64S, SL32S, or 32] EXT 1	Mackie Control Extender	PreSonus [SL32SX or 24] EXT 1	Mackie Control Extender	PreSonus [SL32SC or 16] EXT 1	Mackie Control Extender
PreSonus [SL64S, SL32S, or 32] EXT 2	Mackie Control Extender	PreSonus [SL32SX or 24] EXT 2	Mackie Control Extender		
PreSonus [SL64S, SL32S, or 32] EXT 3	Mackie Control Extender				

Note: You must create the correct device for each MIDI port and assign both the Input and Output to the appropriate MIDI port on your StudioLive for full functionality.

2.1.3 Setting up your Mixer in Logic

The Mackie Control Universal Emulation (Logic) mode has been optimized for use with Apple's Logic software. While also compatible with any DAW that supports the Mackie Control Universal protocol, performance may vary depending upon how this control protocol has been implemented by the DAW's design team.

Before you launch Logic, please make sure that the following steps have been completed to ensure proper connectivity:

- Network your StudioLive to your computer.
- Launch Universal Control and make sure your mixer's Network MIDI ports are enabled.
- Engaged Mackie Control Universal Emulation (Logic) on your mixer.
- Leave Universal Control running in the background.
DO NOT CLOSE THIS APPLICATION.

Open Logic and follow the following steps to set up your StudioLive as a control surface:

1. If you do not have Advanced preferences enabled, go to Logic Pro | Preferences | Advanced Tools...

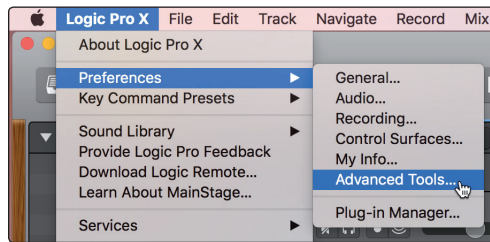

2. Enable "Show Advanced Tools."

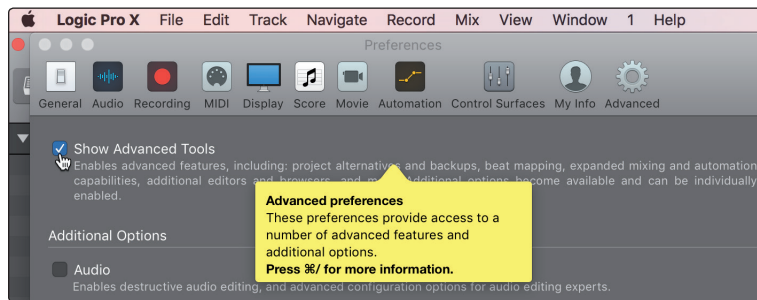

3. Go to Logic Pro | Control Surfaces | Setup...

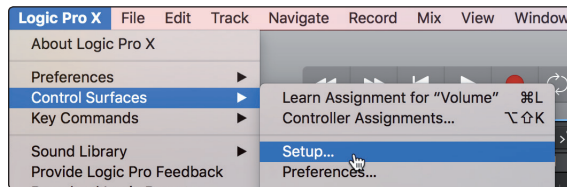

4. In the pop-up menu, go to New | Install...

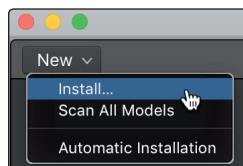

5. From the list of devices, select Mackie Control.

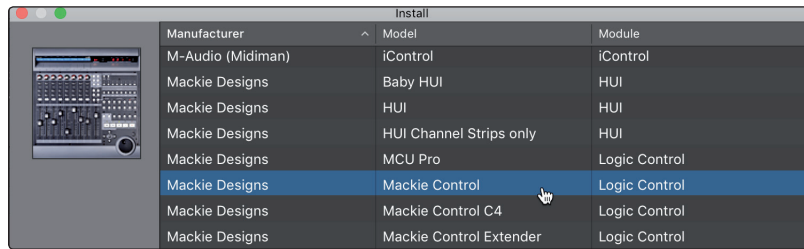

6. Click Add.

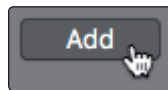

7. In the Inspector, set the Input and Output ports to "UCNET MIDI StudioLive Main."

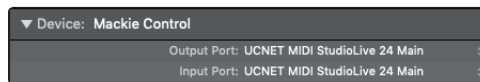

8. In the Inspector, go to New | Install...

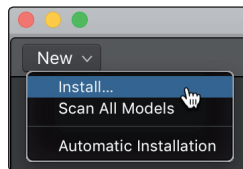

9. From the list of devices, select Mackie Control Extender.

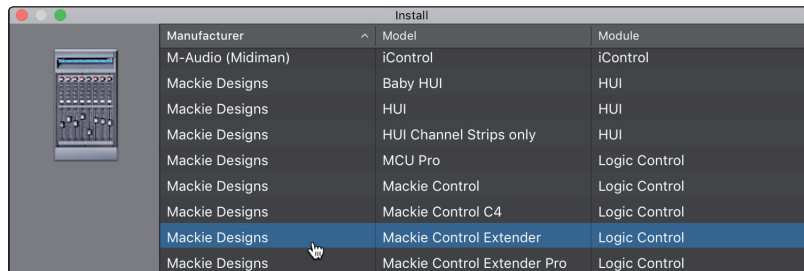

10. Click Add.

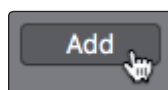

11. Select the Mackie Control Extender device and set the Input and Output ports to "UCNET MIDI StudioLive EXT 1."

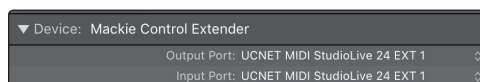

StudioLive 32SC and 16 Users: Your StudioLive is now ready to use!

StudioLive 32SX and 24 Users: Repeat steps 8-11 and create a second Mackie Control Extender device, setting the Input and Output ports to "UCNET MIDI StudioLive EXT 2."

StudioLive 64S, 32S, and 32 Users: Repeat steps 8-11 twice, creating a second and third Mackie Control Extender device, setting the Input and Output ports to "UCNET MIDI StudioLive EXT 2" and "UCNET MIDI StudioLive EXT 3" respectively.

3.2 Fat Channel Controls

The following Mackie Control Universal control functions are available from these Fat Channel buttons:

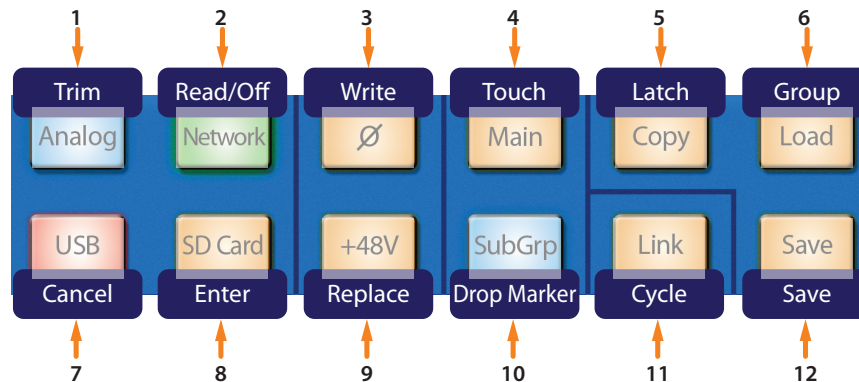

1. **Trim.** Press the Analog button to enable Trim automation on the currently selected track. This function is also available from the Touchscreen. *See Section 3.1 for details.*
2. **Read/Off.** Press the Network button to enable Read automation on the currently selected track. This function is also available from the Touchscreen. *See Section 3.1 for details.*
3. **Write.** Press the Polarity button to enable Write automation on the currently selected track. This function is also available from the Touchscreen. *See Section 3.1 for details.*
4. **Touch.** Press the Main button to enable Touch automation on the currently selected track. This function is also available from the Touchscreen. *See Section 3.1 for details.*
5. **Latch.** Press the Copy button to enable Latch automation on the currently selected track. This function is also available from the Touchscreen. *See Section 3.1 for details.*
6. **Group.** Press the Load button to enable Group automation on the currently selected track. This function is also available from the Touchscreen. *See Section 3.1 for details.*
7. **Cancel.** Press the USB button to select the Cancel utility control. This function is also available from the Touchscreen. *See Section 3.1 for details.*
8. **Enter.** Press the SD button to select the Enter utility control. This function is also available from the Touchscreen. *See Section 3.1 for details.*
9. **Replace.** Press the +48V button to enable the Replace function.
10. **Drop Marker.** Press the Subgroup button to drop a marker at the current playback position.
11. **Cycle.** Press the Link button to enable Cycle.
12. **Save.** Press the Save button to store your session.

3.3 Encoder and Buttons

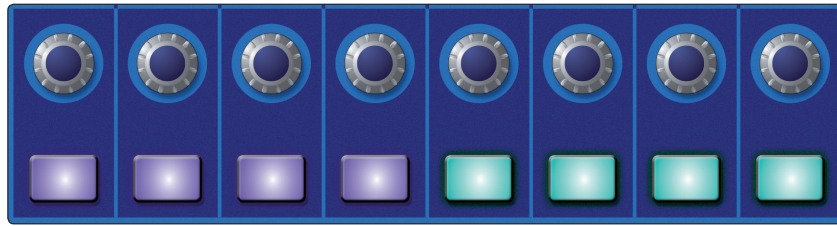

The eight buttons and encoders of your StudioLive's Fat Channel can be used to control many different functions in Mackie Control Universal. Use the Fat Channel mode buttons to switch their functions as follows:

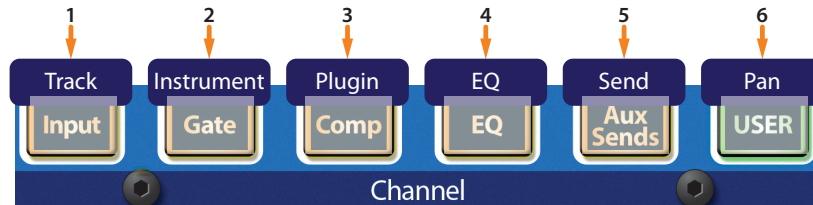

1. **Track.** Press the Input button to access Track mode.
2. **Instrument.** Press the Gate button to access Instrument mode.
3. **Plugin.** Press the Comp button to access Plugin mode.
4. **EQ.** Press the EQ button to access EQ mode.
5. **Send.** Press the Aux Sends button to access Send mode.
6. **Pan.** Press the User button to access Pan mode.

3.4 Fader Banks



Use the **Next** and **Prev** buttons to navigate through channels and banks as follows:

- **StudioLive 24- and 32-fader Models:** Use the Next and Prev buttons on the left side of your mixer to navigate through channels. Use the Next and Prev buttons on the right side of your mixer to navigate through banks.
- **StudioLive 16-fader Models:** Use the Next and Prev buttons to navigate through channels. To navigate through banks, hold the Shift button on your mixer while pressing these buttons.

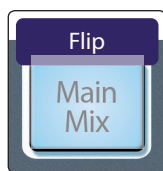

Press the **Main Mix** button to access Flip mode.

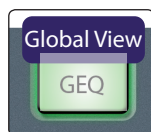

Press the **GEQ** button for Global View.

3.5 Transport and Navigation

The following session navigation controls are available from your StudioLive mixer:

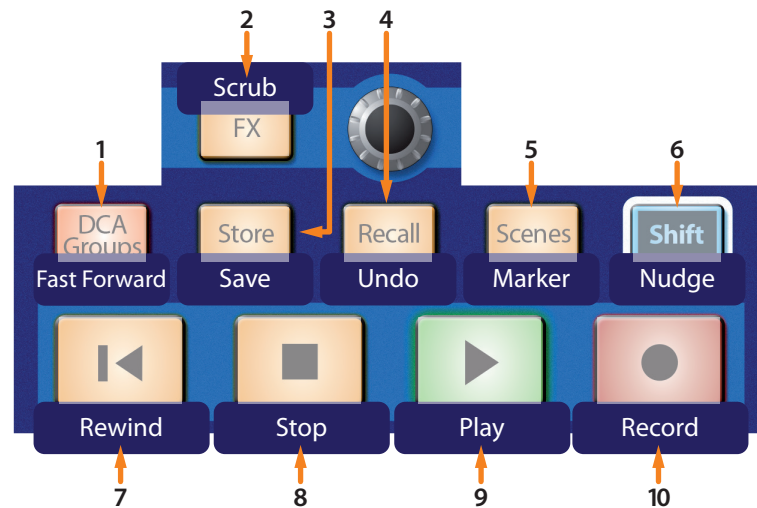

1. **Fast Forward.** Press the DCA Groups button to engage Fast Forward.
2. **Scrub.** Press the FX button to engage Scrub. Use the encoder to move forward or reverse.
3. **Save.** Press the Store button to Save your session. This function is also available from the Touchscreen. *See Section 3.1 for details.*
4. **Undo.** Press the Recall button to Undo the last action. This function is also available from the Touchscreen. *See Section 3.1 for details.*
5. **Marker.** Press the Scenes button to open your markers. New markers can be created by pressing the Subgroup button. *See Section 3.2 for details.*
6. **Nudge.** Press the Shift button to engage nudge.
7. **Rewind.** Press the Return to Zero button to engage rewind.
8. **Stop.** Press to Stop playback.
9. **Play.** Press to start playback.
10. **Record.** Press to engage record.

Please note that the Transport on your StudioLive (Call-out numbers 7-10) can be used for software control or retain local control over your StudioLive mixer's SD recorder. *See Section 2.1.2 for details.*

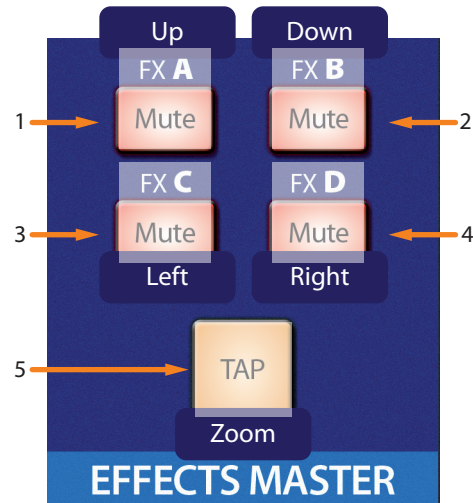

1. **Up.** Press the FXA Mute button to navigate up.
2. **Down.** Press the FXB Mute button to navigate down.
3. **Left.** Press the FXC Mute button to navigate left.
4. **Right.** Press the FXD Mute button to navigate right.
5. **Zoom.** Press the TAP button to zoom.

3.6 Modifiers

The following modifiers are available from the StudioLive control surface:

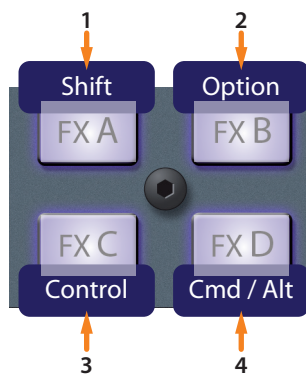

1. **Shift.** Press the FXA mix select button to access the Shift function.
2. **Option.** Press the FXB mix select button to access the Option function.
3. **Control.** Press the FXC mix select button to access the Control function.
4. **Cmd/Alt.** Press the FXD mix select button to access the Command (macOS) or Alt (WIN) functions.

3.7 Global View

As mentioned in Section 3.1, the Global View options are available from the Touchscreen. These views are also accessed from the Touchscreen.

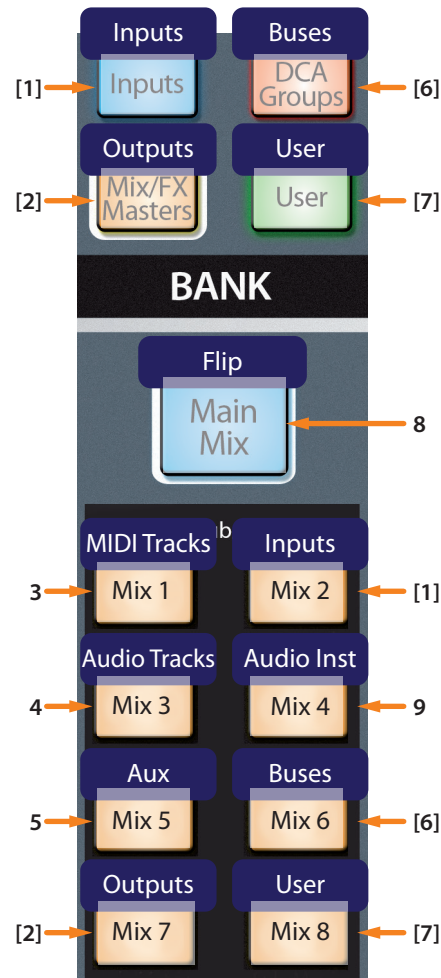

1. **Inputs.** Press the Inputs or Mix 2 buttons for the Inputs view.
2. **Outputs.** Press the Mix/FX Master or the Mix 7 buttons for the Outputs view.
3. **MIDI Tracks.** Press the Mix 1 button to access the MIDI view.
4. **Audio Tracks.** Press the Mix 3 button to access the Audio Tracks view.
5. **Aux.** Press the Mix 5 button to access the Aux view.
6. **Buses.** Press the DCA Groups or Mix 6 buttons to access the Buses view.
7. **User.** Press the User or Mix 8 buttons to access the User view.
8. **Main Mix.** Press the Main Mix to access Flip mode.
9. **Audio Instruments.** Press the Mix 4 button to access the Audio Instruments view.

3.8 User Functions

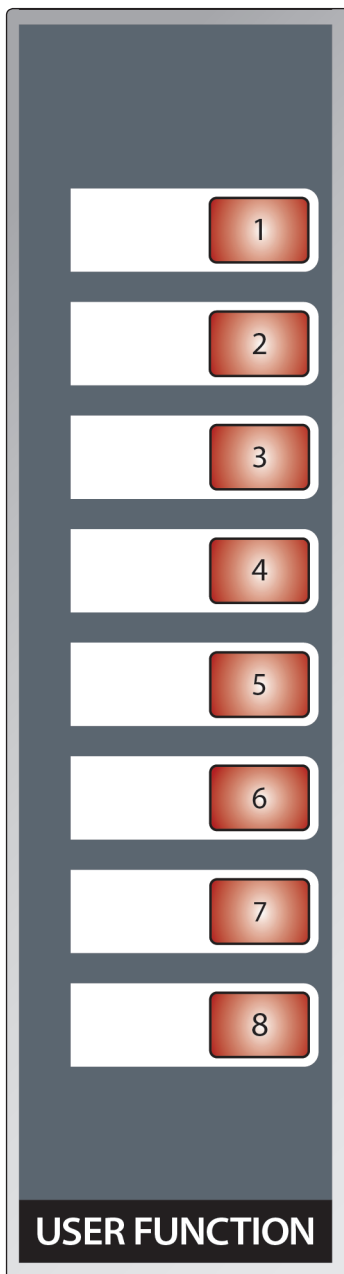

As mentioned in **Section 3.1**, the F1-F8 functions are available from the Touchscreen. These functions are also available on the User Function buttons.

Note: Because of their compact size, the StudioLive 32SC and StudioLive 16 do not offer this additional functionality.

Added bonus: PreSonus' previously Top Secret recipe for...

Rice Dressing

Ingredients:

- 1 lb ground beef
- 1 lb chopped chicken liver
- 1 onion (diced)
- 2 green peppers (diced)
- 4-6 celery stalks (diced)
- 2 garlic cloves (minced)
- ¼ C. chopped fresh parsley
- 3 C. chicken stock
- 6 C. cooked rice
- 1 Tbs. oil
- Salt and pepper to taste
- Cayenne pepper to taste

Cooking Instructions:

1. In a large pot, heat oil on medium high and add meat, salt, and pepper to taste. Stir until meat begins to brown.
2. Lower heat and add all vegetables. Cook until onions are transparent and celery is very tender. Add stock as necessary to prevent burning.
3. Stir in cooked rice. Add remaining stock and simmer on low until ready to serve.

StudioLive™ Series III

StudioLive Series III MCU Emulation for Logic DAW Control Addendum

MCU



18011 Grand Bay Ct. • Baton Rouge,
Louisiana 70809 USA • 1-225-216-7887
www.presonus.com

Part# 70-52000118-B