

NSB-Series Stageboxes

AVB Remote I/O

Owner's Manual

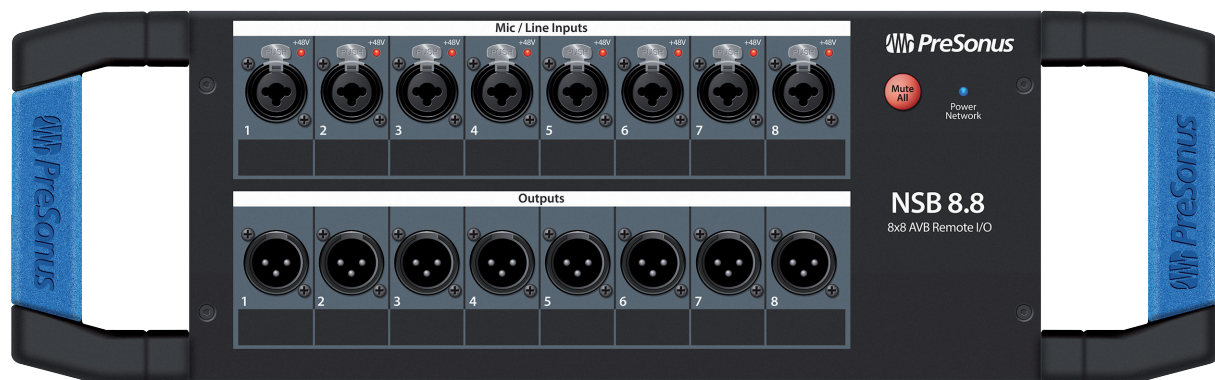
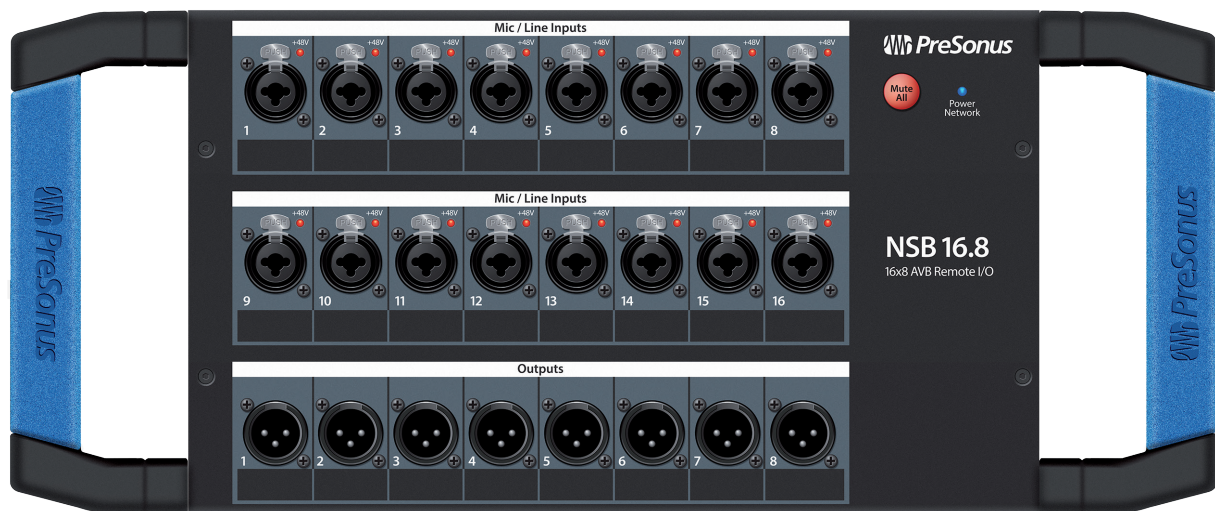

Table of Contents

1 Overview — 1

- 1.1 Introduction — 1
- 1.2 About This Manual — 1
- 1.3 What's in the Box — 2
 - 1.3.1 What Else You Need — 2
- 1.4 Companion PreSonus Products — 3

2 Getting Started — 4

- 2.1 Direct connect with a StudioLive Series III mixer — 4
- 2.2 Direct connect with a StudioLive Series III rack mixer — 8
- 2.3 Using an NSB-series Stage Box with Two or More Mixers — 11

3 Gain Compensation — 19

- 3.1 Remote Preamp Control (Console Mixers) — 19
- 3.2 Remote Preamp Control (UC Surface) — 20

4 Hookup — 22

- 4.1 Front-Panel Connections — 22
- 4.2 Left-panel Connections — 23
- 4.3 Right-panel Connections — 23

5 Technical Information — 24

- 5.1 Specifications — 24

6 Warranty — 25

- 6.1 Warranty Information — 25

1 Overview

1.1 Introduction



Thank you for purchasing an NSB-series AVB-networked stage box. Designed to work seamlessly with the PreSonus StudioLive® Series III digital mixers, the NSB-series networked stage boxes provide a high-quality, expandable, networked, remote I/O solution for stage, installed sound systems, or studio recording.

PreSonus Audio Electronics is committed to constant product improvement, and we highly value our customers and their creative endeavors. We appreciate the support you have shown us by purchasing your NSB-series stage box and are confident that you will enjoy for years to come!

1.2 About This Manual

We suggest you spend some time with this manual before beginning to work with your NSB-series stage boxes, and familiarize yourself with their features, functions, and proper connection procedures. This will facilitate configuring your AVB network and make the process go as smoothly as possible.

This manual describes the functions of the NSB-series stage boxes with StudioLive Series III digital mixers. More information about AVB Networking best practices and configurations can be found in the PreSonus AVB Networking Guide, and we highly recommend that you review this document as well, to avoid any difficulty in creating your AVB network. This manual covers basic connection and use case configurations only. For more complex routing examples, **please review the PreSonus AVB Networking Guide**.

Throughout this manual, you will find **Power User Tips**. These suggestions provide useful information on getting the most out of your NSB stage box as well as explanations of various useful audio terminology.

Thank you, once again, for purchasing our product. We are confident that you will enjoy your new NSB stage box.

Note: When using your NSB stage box with a StudioLive Series III mixer, your mixer will require the latest firmware and Universal Control version for proper functionality. Please log into your My PreSonus user account and update all associated software for your PreSonus AVB products before proceeding.

1.3 What's in the Box

In addition to a Quick Start Guide, your NSB-series stage box package contains the following:



- NSB16.8 or NSB8.8 AVB-networked stage box
- IEC Power Cord.

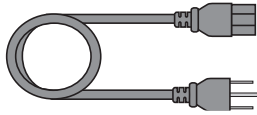

1.3.1 What Else You Need

- AVB Switch

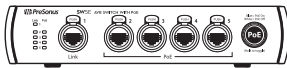

The PreSonus SW5E AVB PoE Switch is fully compatible with all PreSonus AVB products and third-party AVB devices that adhere to the 1722.1 AVB standard. *For a complete list of compatible third-party AVB switches, please visit www.presonus.com.*

- Ethernet Cable

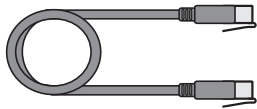

PreSonus requires a CAT5e or CAT6 Ethernet cable for all AVB devices. These can be acquired at most electronics dealers or www.presonus.com

- 1722.1 AVB-compatible mixer

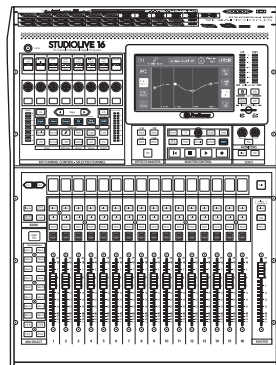

All PreSonus StudioLive Series III mixer models are fully compatible with the 1722.1 AVB standard and NSB-series stage boxes. If you are using a third-party AVB mixer, please contact the manufacturer to verify compatibility with this standard.

- NSB16.8 or NSB8.8 Rack adapter

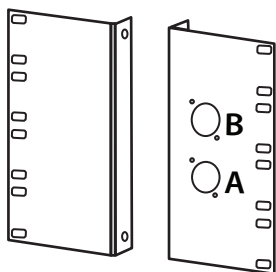

PreSonus has designed the NSB16.8 and NSB8.8 adapters to mount the NSB-series stage boxes in standard 19" equipment rack. This accessory is sold separately at your favorite PreSonus dealer or at www.presonus.com.

1.4 Companion PreSonus Products

Welcome to the PreSonus Ecosystem! As a solutions company, we believe the best way to take care of our customers (that's you) is to ensure that you have the best possible experience from the beginning of your signal chain to the end. In order to achieve this goal, we've prioritized seamless integration throughout every design phase of these products from day one. The result is systems that communicate with each other as intended—straight out of the box—without excessive configuration hassle.

For more information on how our PreSonus AVB networking devices play so well with one another, *please review the PreSonus AVB Networking Guide.*

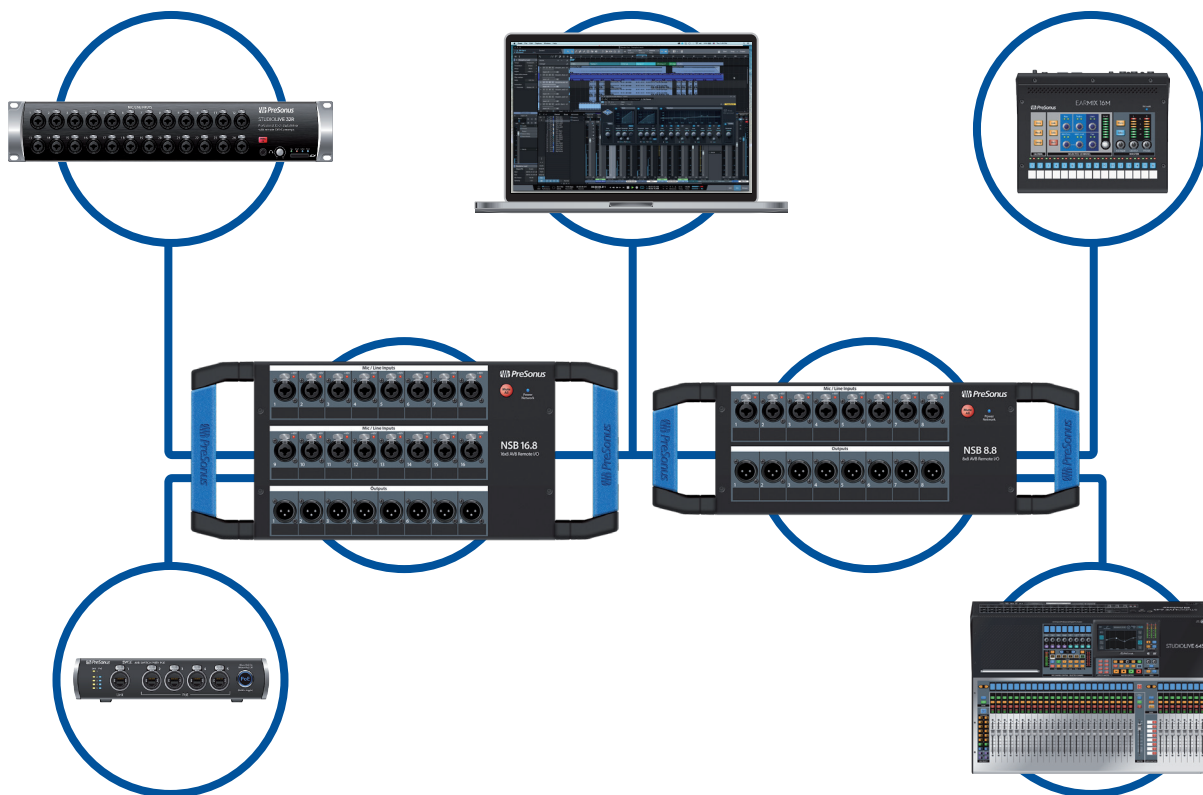

2 Getting Started

The PreSonus NSB-series stage boxes make it easy to get audio to and from the stage using an AVB network. With AVB networking, input and output signals flow through one lightweight CAT5e or CAT6 Ethernet cable. In addition, NSB-series' inputs, preamps, and phantom power can be remotely controlled from your networked StudioLive Series III console or from any device running PreSonus UC Surface touch-control software.

Before you begin, here are a few rules to get you started:

- If your mixer or your NSB-series stage box is not properly gain staged, none of your mixes will sound their best.
- Do not allow your inputs to clip. Watch the level meters; when the signal nears clipping, the top LED will illuminate, indicating that the digital-to-analog converters are in danger of being overdriven.

The following tutorials having been created for two common applications, but can be altered accordingly for your personal needs. More complex use case examples can be found in the *PreSonus AVB Networking Guide*.

2.1 Direct connect with a StudioLive Series III mixer

With the exception of the StudioLive 64S and StudioLive 16R, every StudioLive Series III mixer is a 32-channel mixer with 16 FlexMixes regardless of its complement of onboard I/O. In this example, we will be looking at using on NSB16.8 to expand the I/O capability of the StudioLive 32SC console mixer, so that it has 32 inputs and 16 outputs.

Connect your NSB16.8 to your StudioLive 32SC as shown below and power on your equipment:

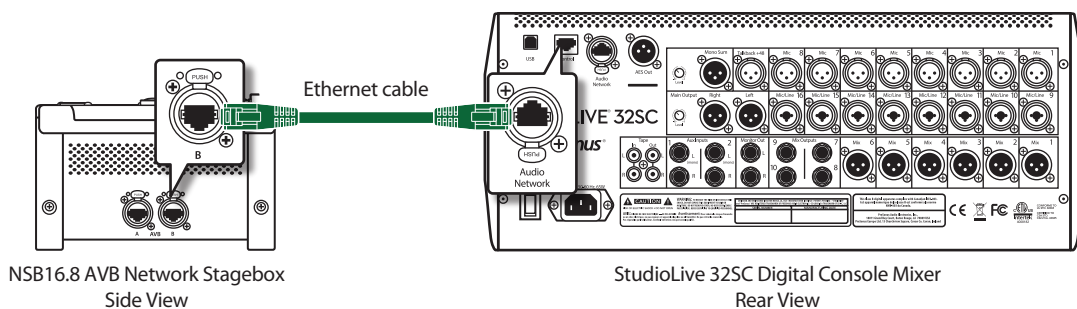

Step 1: Connect Your Stage Box to Your Mixer

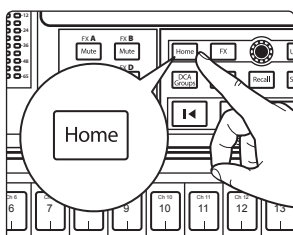

1. Press the Home button on your StudioLive Series III mixer.

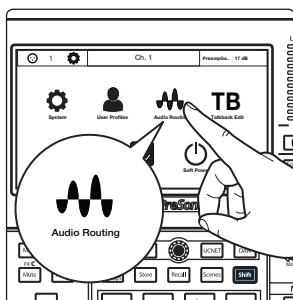

2. Press the Audio Routing icon on the Touchscreen.

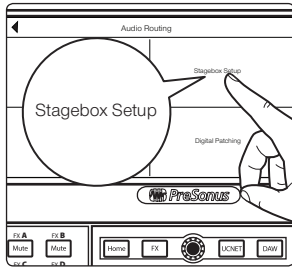

3. Press the Stagebox Setup button on the Touchscreen.

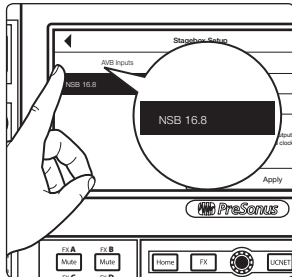

4. Select the NSB16.8 from the list on the left.

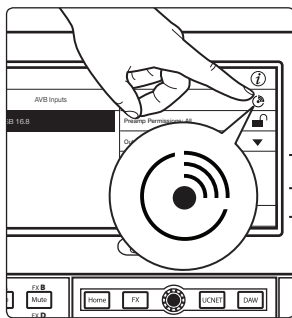

Power User Tip: In applications where you are using multiple NSB-series stage boxes of the same model, you can press the Identify button. This will flash the Power Network LED on the front of the selected NSB stage box from green to red, allowing you to quickly locate your selection.

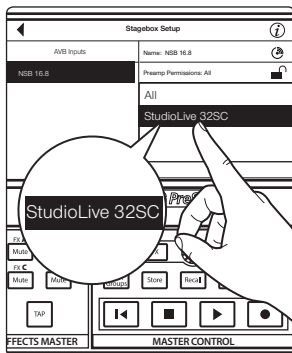

5. Select the mixer you'd like to use to control the preamps on your NSB stage box. By default, this is set to "All", enabling any StudioLive Series III mixer on the AVB network to control the preamps on your stage box.

Power User Tip: Because your NSB stage box inputs are most likely routed to multiple sources on your network, PreSonus highly recommends designating one mixer to control the NSB preamps.

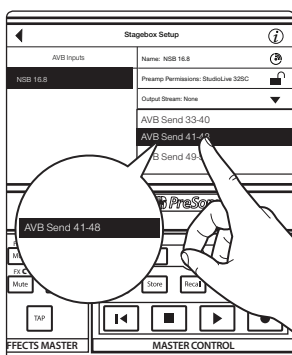

6. Select the AVB Output Sends you'd like returned to the physical outputs on your NSB stage box. Because the AVB streams must be routed in banks of 8, you can only source these outputs from one mixer on the network.

Note: You must assign an output stream from your mixer to your NSB-series stage box so that it is clocked properly over the network. If you do not assign an output stream from your mixer, your networked stage box will not be properly synced and you will hear audio artifacts. For more information on clocking over AVB, please review the AVB Networking Guide.

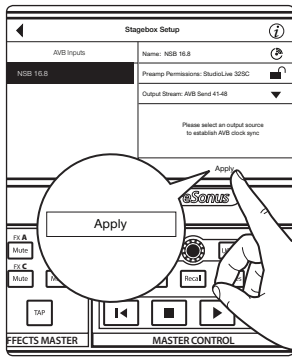

- Press the Apply button when finished.

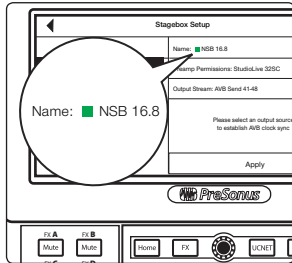

Power User Tip: Once send streams from your mixer have been successfully patched, you will see a green status indicator next to your NSB stage box in the setup screen.



The Power Network LED on your NSB stage box will turn from green to blue when proper clock sync has been established with the AVB network.

Step 2: Routing Stage Box Inputs to Mixer

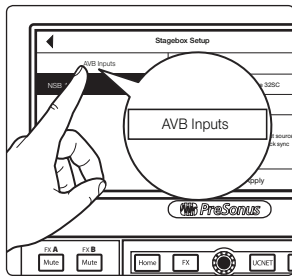

- In our example, we are using the NSB 16.8 to add 16 additional analog inputs and 8 additional analog outputs to a StudioLive 32SC. Press the AVB Inputs button.

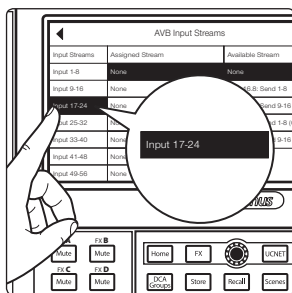

- Select Inputs 17-24 from the Input Streams list.

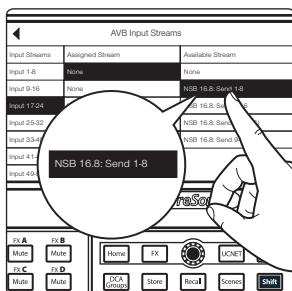

- Select NSB 16.8: Send 1-8 from the Available Stream list to patch the first eight NSB inputs to channels 17-24 on your mixer.

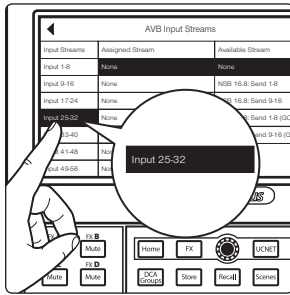

4. Select Inputs 25-32 from the Input Streams list.

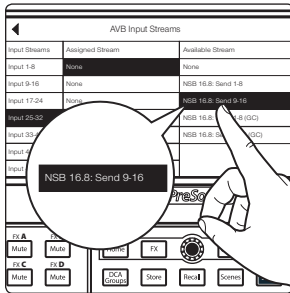

5. Select NSB 16.8: Send 9-16 from the Available Stream list to patch the second eight NSB inputs to channels 25-32 on your mixer.

Note: NSB stage boxes have two sets of streams: one with Gain Compensation and one without. In our example, the StudioLive 16 has total preamp control over the NSB stage box and is the only mixer connect to its streams. Because of this, Gain Compensation is not required in this example. Please review Section 3 for more information on Gain Compensation and when it is advantageous or even required.

Step 3: Engaged Network Sources

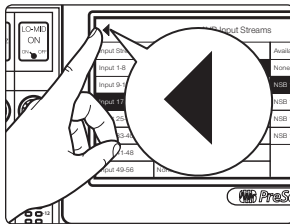

1. Press the back arrow twice to return to the Audio Routing screen.

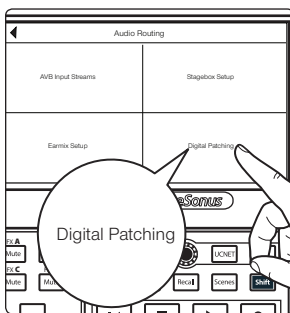

2. Press Digital Patching.

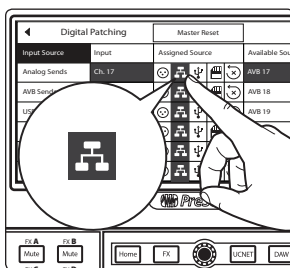

3. Select Input Source and scroll to Inputs 17-32. Assign each to the Network source by pressing the Network button next to each Input.

OR

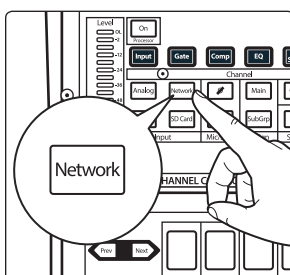

Select each channel and press the Network button from the Input source section in the Fat Channel.

Your NSB 16.8 is now ready to use!

2.2 Direct connect with a StudioLive Series III rack mixer

In this example, we will be looking at using one NSB8.8 to expand the I/O capability of the StudioLive 24R rack mixer, so that it has 32 inputs and 16 outputs.

Connect your NSB8.8 to your StudioLive 24R as shown below and power on your equipment:

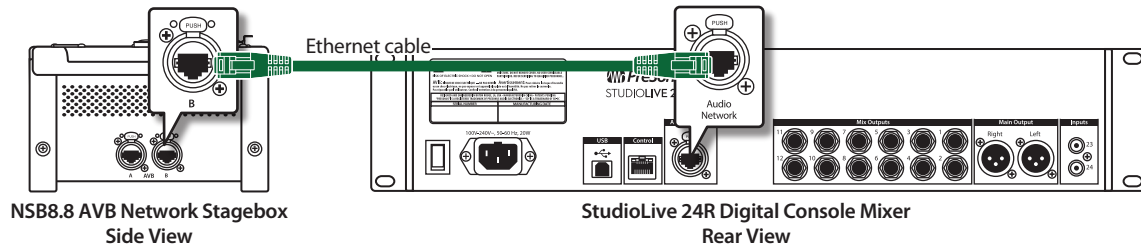

Step 1: Connect Your Stage Box to Your Mixer

1. Launch UC Surface and connect to your StudioLive 24R.



2. Click or Tap on the Settings Gear.

3. Click or Tap on the Network tab.

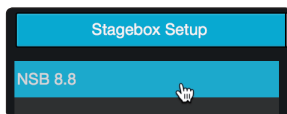
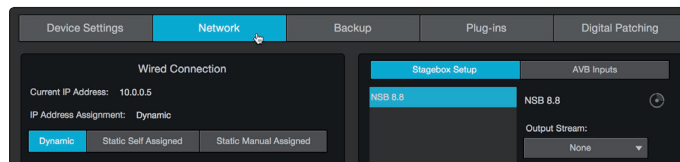

4. In the Stagebox Setup area, select the NSB8.8 from the list.



Power User Tip: In applications where you are using multiple NSB-series stage boxes of the same model, you can press the Identify button. This will flash the Power Network LED on the front of the selected NSB stage box from green to red, allowing you to quickly locate your selection.

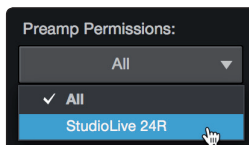

5. Select the mixer you'd like to use to control the preamps on your NSB stage box. By default, this is set to "All", enabling any StudioLive Series III mixer on the AVB network to control the preamps on your stage box.

Power User Tip: Because your NSB stage box inputs are most likely routed to multiple sources on your network, PreSonus highly recommends designating one mixer to control the NSB preamps.

6. Select the AVB Output Sends from the StudioLive 24R you'd like returned to the physical outputs on your NSB stage box. Because the AVB streams are routed must be routed in banks of 8, you can only source these outputs from one mixer on the network.

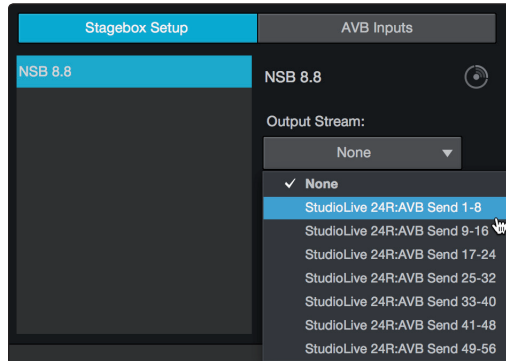

Note: You must assign an output stream from your mixer to your NSB-series stage box so that it is clocked properly over the network. If you do not assign an output stream from your mixer, your networked stage box will not be properly synced and you will hear audio artifacts. For more information on clocking over AVB, **please review the StudioLive Series III AVB Networking Guide.**

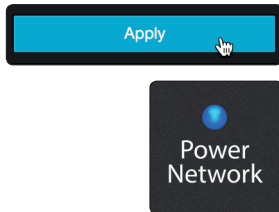

7. Press the Apply button when finished.

The Power Network LED on your NSB stage box will turn from green to blue when proper clock sync has been established with the AVB network.

Step 2: Routing Stage Box Inputs to Mixer

In our example, we are using the NSB 8.8 to add 8 additional analog inputs and 8 additional analog output to a StudioLive 24R.

1. Click on the AVB Inputs tab.



2. Next to Inputs 25-32, select NSB 8.8: Send 1-8 from the Available Stream dropdown menu. This will patch the eight inputs on your NSB 8.8 to channels 25-32 on your StudioLive 24R.

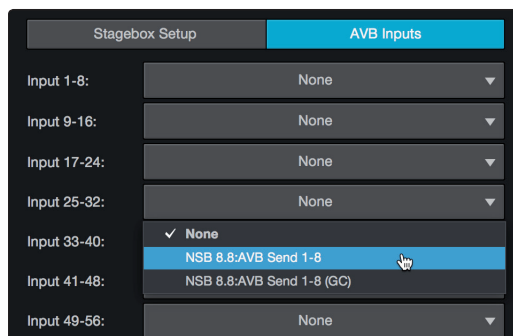

Note: NSB stage boxes have two sets of streams: one with Gain Compensation and one without. In our example, the StudioLive 24R has total preamp control over the NSB stage box and is the only mixer connect to its streams, because of this, Gain Compensation is not required in this example. **Please review Section 3 for more information on Gain Compensation and when it is advantageous or even required.**

Step 3: Engaged Network Sources

1. Click or tap on the Digital Patching tab.

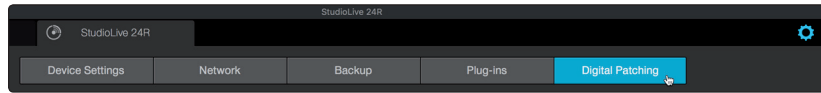

2. By default, the Input Source tab will be active. Select AVB from the Source Type selection.

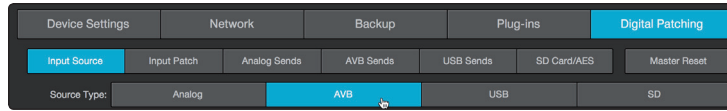

3. Click or tap on the source icon for Channels 25-32 to change each channel's source input to AVB. This will enable the corresponding NSB stage box input to each channel (e.g. NSB Input 1 will be enabled on StudioLive 24R channel 25, NSB Input 2 will be enabled on StudioLive 24R channel 26, etc.)



Your NSB 8.8 is now ready to use!

2.3 Using an NSB-series Stage Box with Two or More Mixers

The same stage box can be used as a source for multiple mixers on the network. This situation is common when there is a mixer at Front-of-House and another mixer at Monitor Position. In this example, we will be using an NSB 8.8 to add eight remote analog inputs to a StudioLive 32SX at front-of-house as well as to add eight additional analog inputs to a StudioLive 24R configured as a monitor mixer to provide a full 32-channel monitor mix solution.

Connect your network as shown below and power on your equipment. Because the NSB-series stage boxes have an AVB switch onboard, you can connect two different devices simultaneously to a single NSB stage box. You also have the option of using a stand-alone AVB switch, like the PreSonus SW5e. Either of the configurations below are supported.

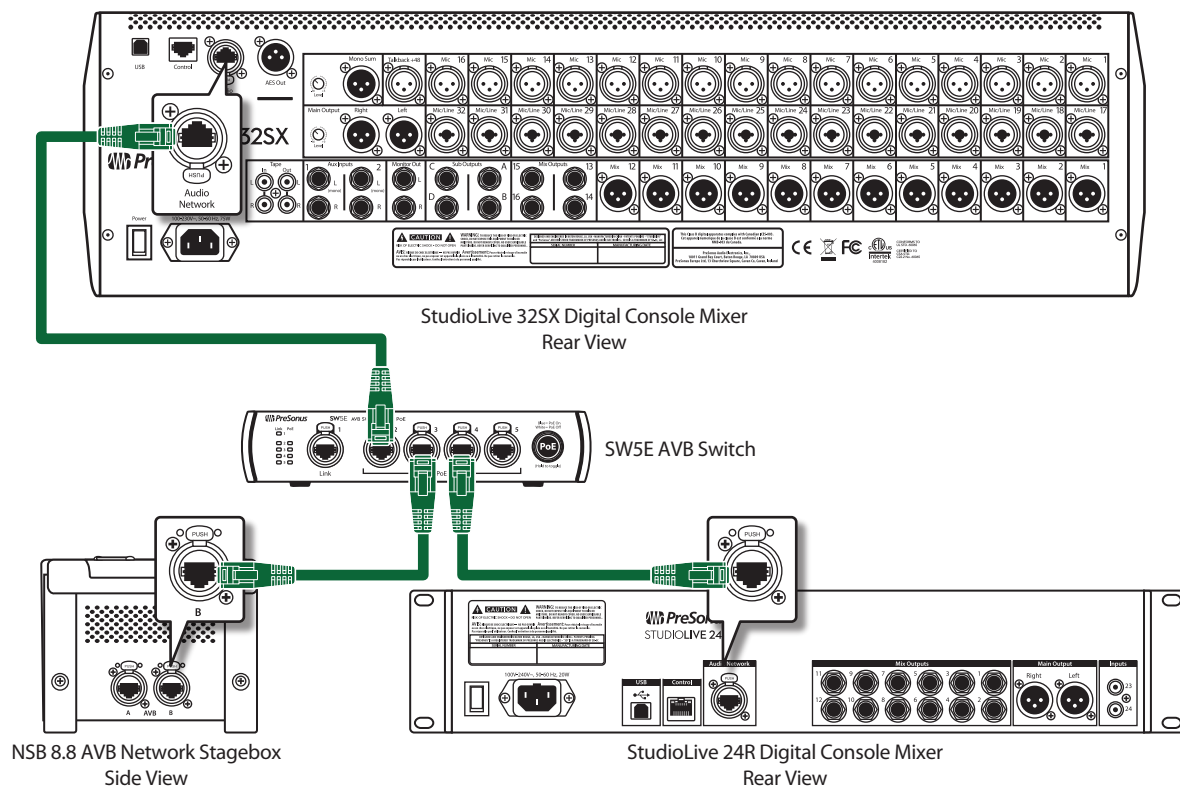
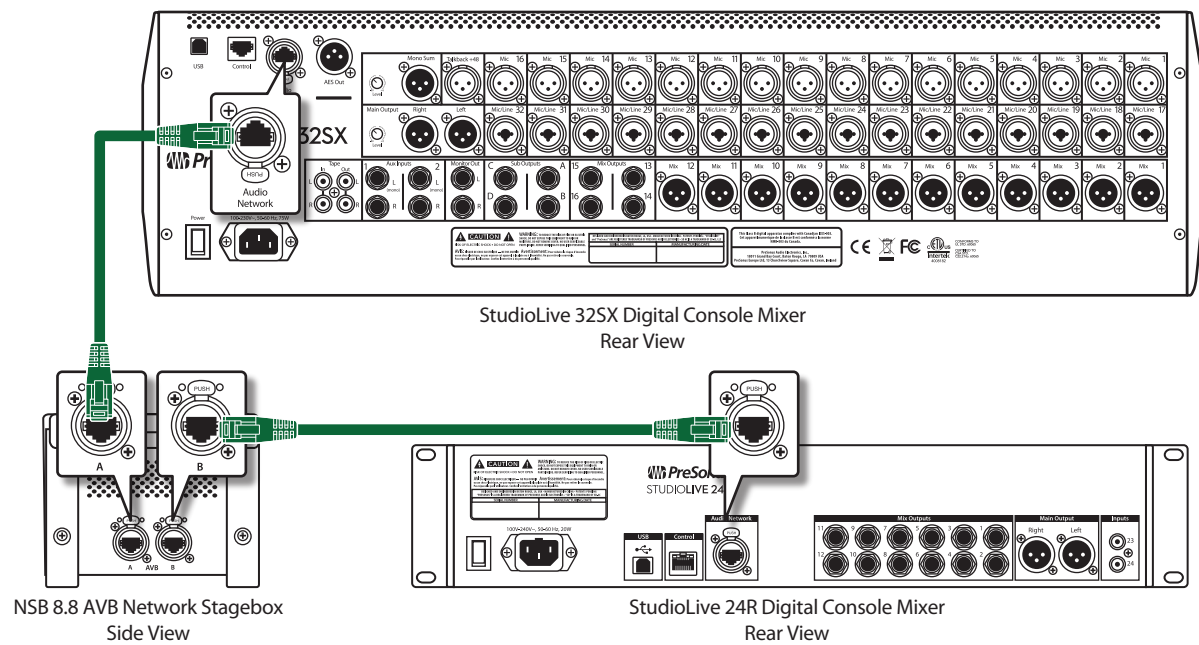

Step 1: Connect Your Rack Mixer (Monitors) to Your Console Mixer (FOH)

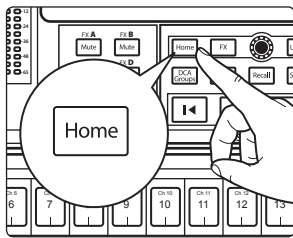

1. Press the Home button on your StudioLive Series III mixer.

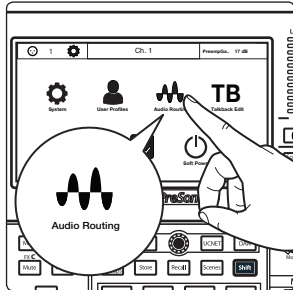

2. Press the Audio Routing icon on the Touchscreen.

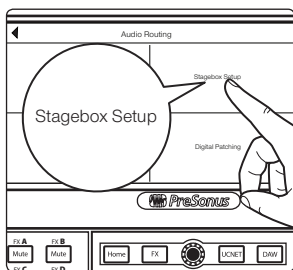

3. Press the Stagebox Setup button on the Touchscreen.

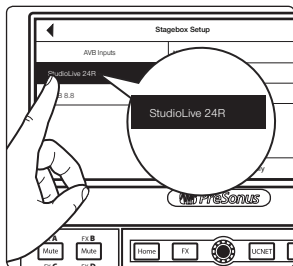

4. Select the StudioLive 24R.

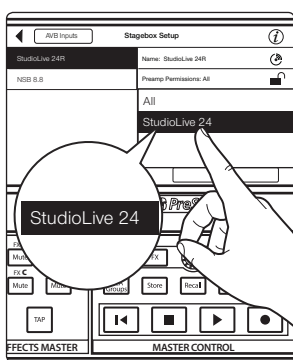

5. In our example, all preamps will be controlled from the Front-of-House mixer, so set the Preamp permissions to StudioLive 32SX.

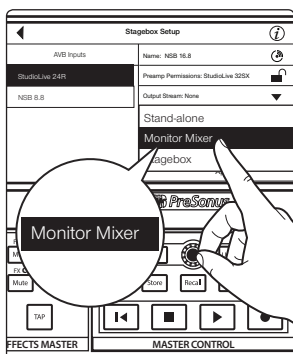

6. Change the Mode to Monitor Mixer.

Note: For complete information on using your rackmount StudioLive Series III mixer as a stage box or monitor mixer with your StudioLive Series III console, please review the *StudioLive Series III Stagebox Mode Addendum*.

Step 2: Connect Your Stage Box to Your Console Mixer (FOH)

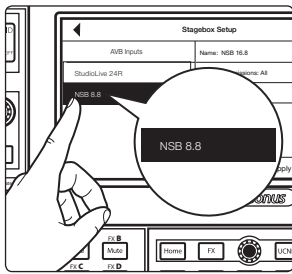

Select the NSB 8.8 from the list on the left.

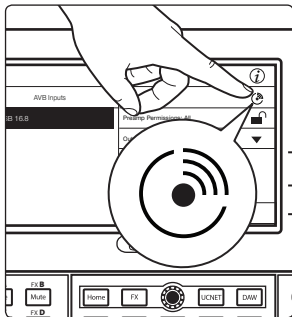

Power User Tip: In applications where you are using multiple NSB-series stage boxes of the same model, you can press the Identify button. This will flash Power / Network LED on the top panel red and green on the currently selected NSB, allowing you to quickly locate your selection.

Step 3: Set Preamp Permissions

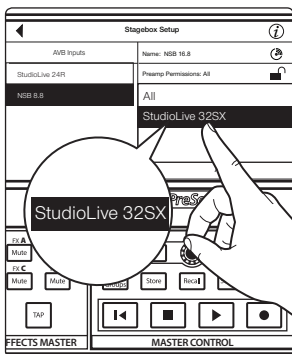

The preamps on NSB-series stage boxes can be controlled from any StudioLive Series III mixer on the network. When you have a stage box feeding more than one mixer, it is recommended that you give only one mixer permission to adjust the NSB preamp levels. In our example, we will be giving permission to the StudioLive 32SX at Front-of-House.

Step 4: Patch Outputs

The NSB-series stage box is equipped with 8 outputs to feed floor monitors, mains, or personal monitoring systems. In our example, we will be using these outputs exclusively for floor monitors and since we have a StudioLive 24R dedicated as a monitor mixer, we will be using its AVB Sends to feed the NSB 8.8 outputs.

Note: Because the AVB streams are routed must be routed in banks of 8, you can only source these outputs from one mixer on the network.

Send and Return connections over the network to and from the NSB-series stage box must be made from each mixer individually. For console mixers, this routing can be made locally, using the LCD, or remotely from UC Surface. All audio routing for rack mixers must be done remotely using UC Surface.

Note: You must assign an output stream from your mixer to your NSB-series stage box so that it is clocked properly over the network. If you do not assign an output stream from your mixer, your networked stage box will not be properly synced and you will hear audio artifacts. **For more information on clocking over AVB, please review the AVB Networking Guide.**

In our example, we will be routing the last 8 FlexMixes from the StudioLive 24R to the physical outputs on the NSB 8.8.

1. In Universal Control, connect to the StudioLive 24R.



2. Click or tap on the Settings Icon.

3. Click or tap on the Network Tab.

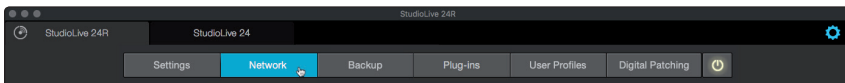

4. In the Stagebox Setup area, select the NSB 8.8.

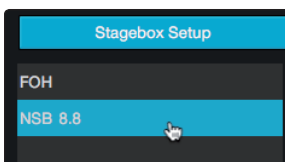

5. From the drop-down menu, select StudioLive 24R Sends 49-56.

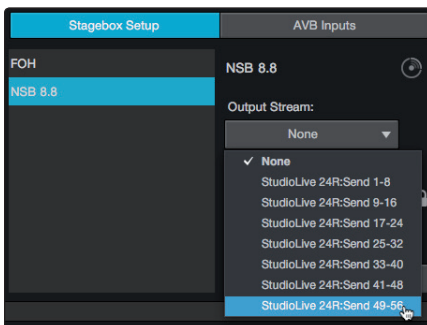

6. Press the Apply button when finished.

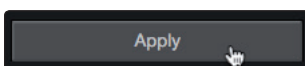

Step 5: Routing inputs to your console mixer

In our example, we are using the NSB 8.8 to add 8 remote inputs to the StudioLive 32S. We will also be routing the audio from the LCD on the console.

1. On the Stagebox Setup screen, press AVB Inputs.

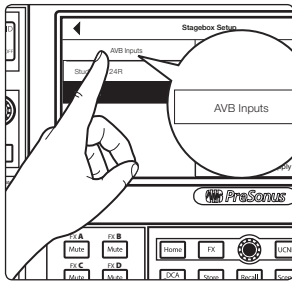

2. Select Input 25-32.

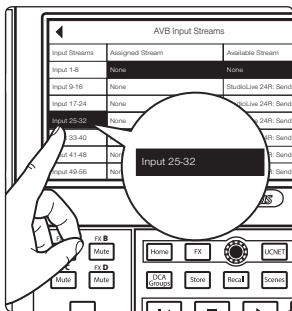

3. From the Available Stream list, use the Value encoder to scroll to NSB 8.8 Send 1-8.

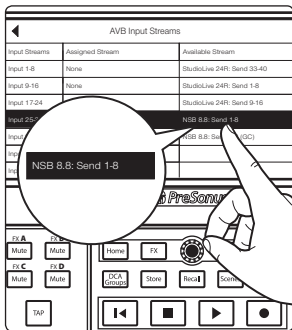

In our example, we will also be using routing inputs 9-24 on the StudioLive 24R as part of our mix on the StudioLive 32SX. Let's go ahead and route those now.

4. Select Input 9-16.

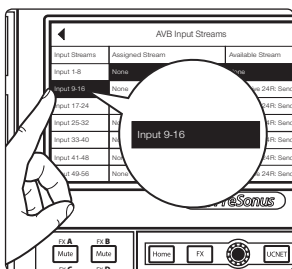

5. From the Available Streams list, use the Value encoder to scroll to StudioLive 24R: Send 9-16.

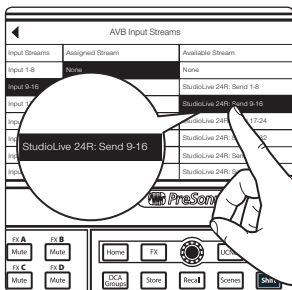

6. Repeat Steps 2-5 with Inputs 17-24 and StudioLive 24R Sends 17-24.

Your StudioLive 32SX is now configured as follows:

- Channels 1-8: No network source available.
- Channels 9-16: Network sourced from StudioLive 24R Inputs 9-16.
- Channels 17-24: Network sourced from StudioLive 24R Inputs 17-24.
- Channels 25-32: Network sourced from NSB8.8 Inputs 1-8.

Step 6: Engaging the Network Sources on your Console Mixer

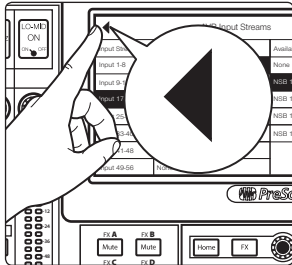

1. Press the back arrow to return to the Audio Routing screen

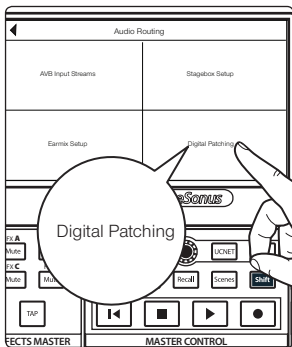

2. Press the Digital Patching button to open the Digital Patching screen.

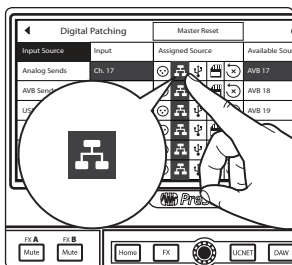

3. Scroll to Inputs 9-32 and assign each to the Network source by pressing the Network button next to each Input.

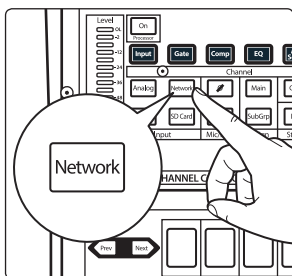

Power User Tip: The Network Source can also be enabled for each channel individually from the Fat Channel. Using the Digital Patching screen allows you to assign the sources to multiple channels at once.

Your NSB 8.8 is now ready to use with your StudioLive 32SX. Now let's set it up for the StudioLive 24R!

Step 7: Routing Inputs to your rack mixer

In our example, we are using the NSB 8.8 to also add 8 more inputs to the StudioLive 24R create a full 32-channel mixer. Let's open up UC Surface and get that routed!



1. In UC Surface connected to your StudioLive 24R, press the Settings gear.

2. Click on the Network Tab.

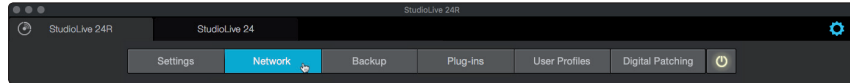

3. From the Stagebox Setup area, click on the AVB Inputs tab.

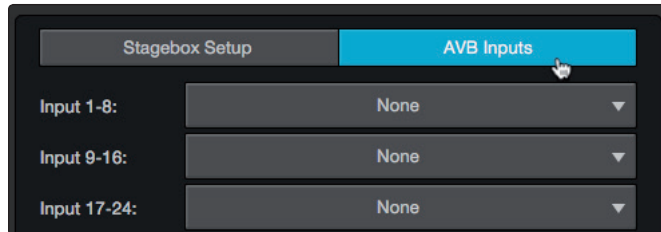

4. Click or tap on the drop-down menu for Input 25-32 and select NSB 8.8: Send 1-8 (GC). These are the gain compensated streams for your NSB 8.8. *Please see Section 3 for more information on Gain Compensation.*

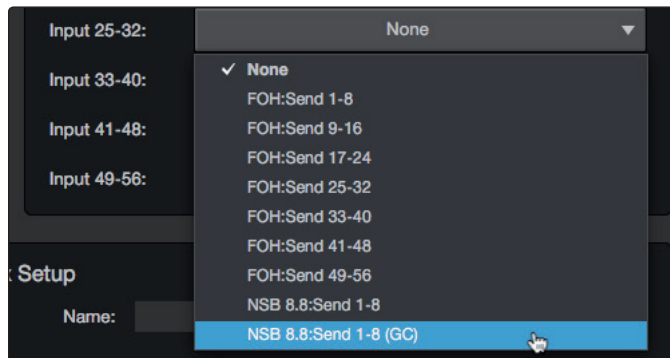

In our example, we will also be using routing inputs 1-8 on the StudioLive 32SX as part of our monitor mix. Let's go ahead and route those now.

5. Click or tap on the drop-down menu for Input 1-8 and select StudioLive 32SX: Send 1-8

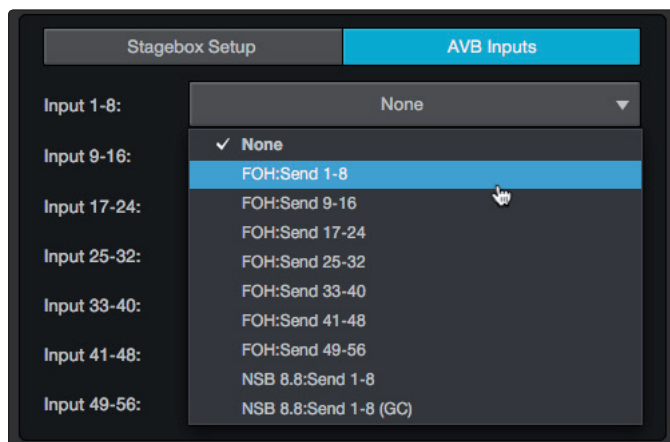

Your StudioLive 24R is now configured as follows:

- Channels 1-8: Network sourced from StudioLive 32SX Inputs 1-9
- Channels 9-16: No network source available. Local sources only (Analog or USB)
- Channels 17-24: No network source available. Local sources only (Analog or USB)
- Channels 25-32: Network sourced from NSB8.8 Inputs 1-8.

Step 8: Engaging the Network Sources on your Rack Mixer

1. Click or tap on the Digital Patching tab.

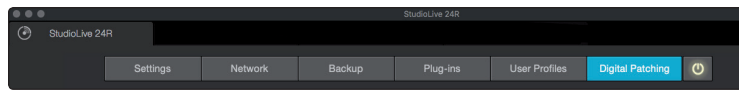

2. Click or tap on the Input Source tab.

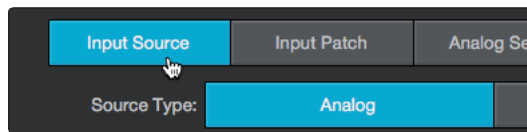

3. Click or tap on the AVB tab.

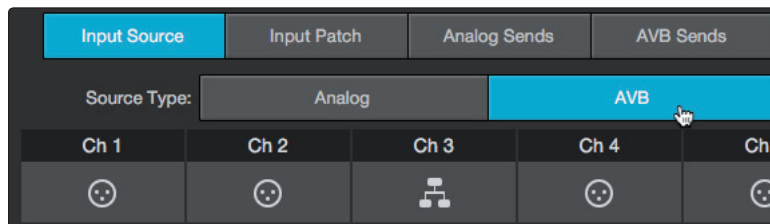

4. Click or tap on the icon on Channels 1-8 and Channels 25-32. This will assign the source for each of these channels to the AVB network.

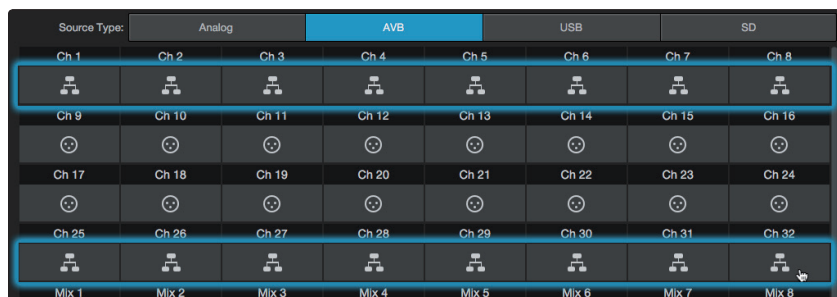

3 Gain Compensation

When your NSB-series stage box is connected to multiple mixers, you have the option to designate only one to have control over the preamps. In this way, only one engineer is in charge of gain staging on stage. Once the preamp level is set by the master mixer, every other mixer on the network has the option of listening to the same stream or the gain compensated stream.

Routing the AVB stream that isn't gain compensated, means that you will have no control over the level of streams feeding the inputs your mixer. While this may be fine in some situations, this could create gain staging issues in others.

Using the Gain Compensated (GC) stream allows you to retain independent gain control on each mixer without potentially harming the Front-of-House mix. NSB stage boxes have an onboard DSP that adjusts the level of the gain compensated streams relative to gain set on the master mixer. In this way, every mixer on the network has a working gain range of +/- 20 dB, even if they are not the set as the master preamp controller for the stage box.

Once Gain Compensation is engaged, the Master mixer can adjust the gain of each NSB preamp +/- 15 dB before the change will be heard locally on any mixer receiving the Gain Compensated stream.

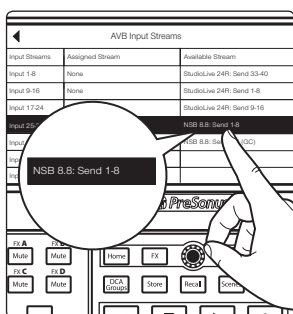

When using a StudioLive Series III console as the master preamp controller for your NSB-series stage box, select the non-Gain Compensated streams for your inputs.

3.1 Remote Preamp Control (Console Mixers)

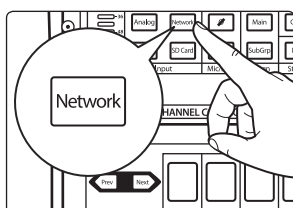

After you route the NSB inputs to your console mixer, select Network for the source on the corresponding channels.

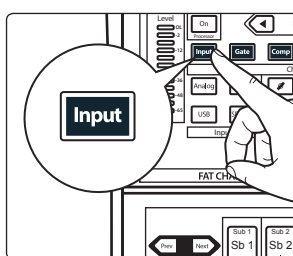

Press Input on the Fat Channel.

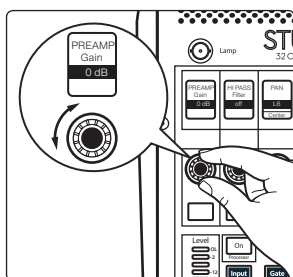

You can now control the preamp level and phantom power for your NSB stage box from the Fat Channel on your console, in the same way that you control the local inputs.

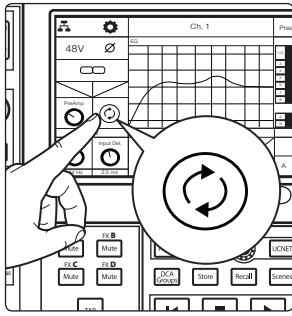

After you have set the preamp levels, enable Gain Compensation from the LCD. This will turn on Gain Compensation for that input and allow other mixers on the network to source that stream.

Note: If you do not enable Gain Compensation, making a change on the mixer with preamp control over the NSB stage box will change it for any device listening to that stream on the network.

3.2 Remote Preamp Control (UC Surface)

After you route the NSB inputs to your console mixer, select Network for the source on the corresponding channels.

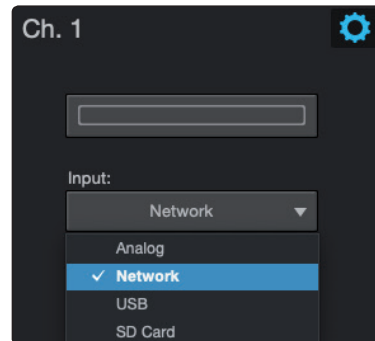

Select the channel for which you'd like to set the gain.



You can now control the preamp level and phantom power for your NSB stage box from the Fat Channel in UC Surface, in the same way that you control the local inputs.



After you have set the preamp levels, enable Gain Compensation. This will turn on Gain Compensation for that input and allow other mixers on the network to source that stream.



Note: If you do not enable Gain Compensation, making a change on the mixer with preamp control over the NSB stage box will change it for any device listening to that stream on the network.

4 Hookup

4.1 Front-Panel Connections



Mic/Line Inputs. The inputs on your NSB-Stagebox can also accept mic- or line-level signals. These inputs use TRS-XLR combo jacks that can accept both XLR and balanced or unbalanced 1/4" cables.

The XLR inputs provide access to the onboard PreSonus XMAX microphone preamplifiers, for use with all types of microphones. The XMAX preamp features a Class A input buffer circuit, followed by a dual-servo gain stage. This results in exceptionally low noise, and a wide range of gain, allowing you to boost signals significantly, without introducing unwanted background noise.

The 1/4-inch TRS connectors bypass the gain stage and are scaled to accept line-level signals up to +18 dBFS. Use these inputs for any line-level device.

Power User Tip: When the line inputs are engaged, the microphone preamp circuit is bypassed completely, and no trim control is available. Typical examples of line-level connections are synthesizer outputs, signal processors, and stand-alone mic preamps and channel strips. Use the output level control on your line-level device to adjust its level.

Note: As with many audio devices, plugging a microphone or line-level device, or enabling/disabling phantom power can create a momentary noise spike in the audio output. It is highly recommended that you mute or turn down a channel's fader before changing connections or toggling phantom power on or off.



Phantom Power Indication. The NSB provides individually-switchable 48V phantom power for each microphone input. The red LED next to each input indicates whether or not Phantom Power has been enabled for the corresponding mic preamp. Whichever mixer has preamp control permissions, also controls the Phantom Power for each input.

WARNING: Phantom power is required for condenser microphones and certain other specialty microphones that contain active preamp circuitry. However, applying phantom power to mics that don't require power can damage them (especially ribbon mics). Switch phantom power off for all channels where it is not required.

XLR connector wiring for phantom power:

Pin 1 = GND Pin 2 = +48V Pin 3 = +48V



Line Out. These balanced XLR line outputs are to connect external devices like powered floor monitors, amplifiers, etc.



Mute All. This button mutes every input and output on your NSB. Use this button to quickly silence your NSB while making connections or disconnecting equipment to avoid volume spikes in your system.



Power Network. This LED displays power and network connectivity.

Red. No network is available.

Green. The NSB stage box is connected to an AVB network.

Blue. The NSB stage box is connected to an AVB network and receiving proper word clock sync.

4.2 Left-panel Connections



AVB A. This locking Ethernet connection should be used to connect your NSB to your AVB network.



AVB B. This locking Ethernet connection can be used to connect your NSB to another NSB or other AVB device. You can also use this connection to daisy chain additional NSB stage boxes or EarMix 16M personal monitor mixers in situations where you are connecting your devices directly to your mixer without an AVB switch or if you have exhausted the available ports on your AVB switch.

Power User Tip: Please refer to the section on hop limitations on AVB networks in the PreSonus AVB Networking Guide before cascading numerous AVB devices without a central switch, like the PreSonus SW5e.

4.3 Right-panel Connections



Power. This Power input accepts power from the included IEC3 Power cord.



Power Switch. This is the on / off switch for your NSB.

5 Technical Information

5.1 Specifications

Microphone Preamplifier

Input Type	XLR Female, balanced
Frequency Response to Main Output (at unity gain)	20-20 kHz, ± 0.5 dBu
Input Impedance	1 k Ω
THD to Main Output	<0.005%, +4 dBu, 20-20 kHz, unity gain, unwt'd
S/N Ratio to Main Output (Ref = +4 dB, 20 kHz BW, unity gain, A-wtd)	94 dB
Common Mode Rejection Ratio (1 kHz at unity gain)	65 dB
Gain Control Range (± 1 dB)	0 dB to +60 dB
Maximum Input Level (unity gain)	+12 dBu
Phantom Power (± 2 VDC)	48 VDC, switchable per channel

Line Inputs

Type	¼" TRS Female, balanced
Frequency Response to Main Output (at unity gain)	20-20 kHz, ± 0.5 dBu
Input Impedance	10 k Ω
THD to Main Output	<0.005%, +4 dBu, 20-20 kHz, unity gain, unwt'd
S/N Ratio to Main Output (Ref = +4 dB, 20 kHz BW, unity gain, A-wtd)	94 dB
Maximum Input Level	+18 dBu

XLR Outputs

Type	XLR Male, balanced
Maximum Output Level	+24 dBu, ± 0.5 dBu
Output Impedance	100 Ω

Digital Audio

ADC Dynamic Range	115 dB (A-wtd, 48 kHz)
DAC Dynamic Range	115 dB (A-wtd, 48 kHz)
AVB Audio Network Ports	Locking XLR Ethernet
Sampling Rate	48 kHz

Power

Connector	Locking IEC
Input-Voltage Range	90 to 230 VAC ($\pm 10\%$)

Physical

Height	NSB 8.8: 5.2" (132 mm) NSB 16.8: 7" (178 mm)
Width	16.7" (424 mm)
Depth	4.5" (114 mm)
Weight	NSB 8.8: 5.4 lbs. (2.4 kg) NSB 16.8: 6.2 lbs. (2.8 kg)

6 Warranty

6.1 Warranty Information

PreSonus' warranty obligations for this hardware product are limited to the terms set forth below:

How Consumer Law Relates To This Warranty:

THIS WARRANTY GIVES YOU SPECIFIC LEGAL RIGHTS, AND YOU MAY HAVE OTHER RIGHTS THAT VARY FROM STATE TO STATE (OR BY COUNTRY OR PROVINCE). OTHER THAN AS PERMITTED BY LAW, PRESONUS® DOES NOT EXCLUDE, LIMIT OR SUSPEND OTHER RIGHTS YOU MAY HAVE, INCLUDING THOSE THAT MAY ARISE FROM THE NONCONFORMITY OF A SALES CONTRACT. FOR A FULL UNDERSTANDING OF YOUR RIGHTS YOU SHOULD CONSULT THE LAWS OF YOUR COUNTRY PROVINCE OR STATE.

PreSonus Products And EU Statutory Warranty:

When you purchase PreSonus products, European Union consumer law provides statutory warranty rights in addition to the coverage you receive from the PreSonus limited warranty. A summary of the EU Statutory Warranty and the PreSonus Limited Warranty is below:

	EU Consumer Law	PreSonus Limited Warranty
Repair or Replacement Coverage For	Defects present when customer takes delivery	Defects arising after customer takes delivery
Warranty Period	2 years (minimum) from original date of purchase (unless superseded by PreSonus)	1 year from original date of purchase (unless superseded by PreSonus)
Cost of Coverage	Provided at no additional cost	Included at no additional cost
Who to contact to make a claim	The seller	PreSonus technical support for your region

What This Warranty Covers:

PreSonus Audio Electronics, Inc., ("PreSonus") warrants defects in material and workmanship in PreSonus-branded products under normal use. This Limited Warranty applies only to hardware products manufactured by or for PreSonus that can be identified by the PreSonus trademark, trade name, or logo affixed to them.

Exclusions and Limitations:

This warranty does not cover the following:

1. Damage caused by accident, abuse, improper installation, failure to follow instructions in the applicable owner's manual or improper operation, rental, product modification, alteration, or neglect.
2. Damage from improper grounding, faulty wiring (AC and signal), faulty equipment, or connection to a voltage range outside published specifications (see applicable owner's manual).
3. Damage to drivers or diaphragm assemblies found to have burnt voice coils from over/under driving or signal surge from another device.
4. Damage occurring during shipment or improper handling.
5. Damage caused by repair or service performed by persons not authorized by PreSonus.
6. Products on which the serial number has been altered, defaced, or removed.
7. Products purchased from an unauthorized PreSonus dealer (products that have transferable warranties are excluded from this provision, provided the customer and the product are registered with PreSonus).

Who This Warranty Protects:

This Warranty protects only the original retail purchaser of the product (products that have transferable warranties are excluded from this provision provided the customer and the product are registered with PreSonus).

How Long This Warranty Lasts:

The Warranty begins on the original date of purchase from the retail purchaser, and the duration is as follows:

1-Year Limited Warranty		
Product Category	Model	Transferable
Recording Interfaces	AudioBox® iOne, AudioBox iTwo, AudioBox Stereo, AudioBox Studio, AudioBox USB, AudioBox VSL (1818, 44, 22), FireStudio™ Project, FireStudio Mobile, FireStudio Mobile Studio, Studio 192, Studio 192 Mobile, Studio-series (1824, 1810, 68, 26), Quantum, and Quantum 2	No
Preamplifiers	ADL600, ADL700, BlueTube DP V2, DigiMax D8, DigiMax DP88, Eureka, RC500, Studio Channel, TubePre V2	No
StudioLive® Mixers	16.0.2, 16.4.2AI, 24.4.2AI, 32.4.2AI, AR8, AR12, AR16, AR22, RM16AI, RM32AI	No
Monitoring & Controlling	Eris®, Central Station PLUS, FaderPort™, HP4, HP60, Monitor Station, Monitor Station V2, R-Series, Sceptre®, Temblor®	No
Network Devices	NSB 8.8 and 16.8, EarMix 16M, SW5E	No
Accessories	Covers, Dolly, PRM1 mic, Sub Pole, breakout cables, power supplies, M10 Kit	No
3-Years Limited Warranty		
Product Category	Model	Transferable
Live Sound	StudioLive AI 328, 312, 315, 18S, ULT10, ULT12, ULT15, ULT18, AIR10, AIR12, AIR15, AIR15S, AIR18S, CDL12, and CDL18s	Yes
StudioLive® Series III Mixers	64S, 32S, 32, 32XS, 32SC, 24, 16, 32R, 24R, and 16R	No

What PreSonus Will Do:

PreSonus will repair or replace, at our sole and absolute option, products covered by this warranty at no charge for labor or materials. If the product must be shipped to PreSonus for warranty service, the customer must pay the initial shipping charges. PreSonus will pay the return shipping charges.

How to Get Warranty Service (USA):

1. You must have an active user account with PreSonus, and your hardware must be on file with your account. If you do not have an account, please go to: <http://www.presonus.com/registration> and complete the registration process.
2. Contact our Technical Support Department at (225) 216-7887 or log a support ticket at: <http://support.presonus.com>. TO AVOID THE POSSIBILITY OF SENDING IN A PRODUCT THAT DOES NOT HAVE A PROBLEM, ALL SERVICE REQUESTS SHALL BE CONFIRMED BY OUR TECH SUPPORT DEPARTMENT.
3. The return authorization number as well as shipping instructions shall be provided after your service request is reviewed and confirmed.
4. The product should be returned for service in the original product packaging. Products may be shipped in a manufactured “flight”- or “road”-style cases but PreSonus will NOT cover any shipping damage to these cases. Products that are not shipped in the original product package or a manufactured case may not receive a warranty repair, at PreSonus’s sole discretion. Depending on the product model and the condition of your original packaging, your product may not be returned to you in the original packaging. The return shipping box may be a generic box that has been fitted for that model tested if the original gift box is not available.

How to Get Warranty Service (outside of USA):

1. You must have an active user account with PreSonus and your hardware must be on file with your account. If you do not have an account, please go to: <http://www.presonus.com/registration> and complete the registration process.
2. Contact the Technical Support/Service Department for your region at http://www.presonus.com/buy/international_distributors and follow procedures provided by your PreSonus contact.

Limitation of Implied Warranties:

ANY IMPLIED WARRANTIES, INCLUDING WARRANTIES OF MERCHANTABILITY AND FITNESS FOR A PARTICULAR PURPOSE, ARE LIMITED IN DURATION TO THE LENGTH OF THIS WARRANTY.

Some states, countries, or provinces do not allow limitations on how long an implied warranty lasts, so the above limitation may not apply to you.

Exclusion of Damages:

PRESONUS'S LIABILITY FOR ANY DEFECTIVE PRODUCT IS LIMITED TO THE REPAIR OR REPLACEMENT OF THE PRODUCT, AT PRESONUS'S SOLE OPTION. IF PRESONUS ELECTS TO REPLACE THE PRODUCT, THE REPLACEMENT MAY BE A RECONDITIONED UNIT. IN NO EVENT WILL PRESONUS BE LIABLE FOR DAMAGES BASED ON INCONVENIENCE, LOSS OF USE, LOST PROFITS, LOST SAVINGS, DAMAGE TO ANY OTHER EQUIPMENT OR OTHER ITEMS AT THE SITE OF USE, AND, TO THE EXTENT PERMITTED BY LAW, DAMAGES FOR PERSONAL INJURY, OR ANY OTHER DAMAGES WHETHER INCIDENTAL, CONSEQUENTIAL OR OTHERWISE, EVEN IF PRESONUS HAS BEEN ADVISED OF THE POSSIBILITY OF SUCH DAMAGES.

Some states, countries, or provinces do not allow limitations on how long an implied warranty lasts, so the above limitation may not apply to you.

If you have any questions about this warranty or service received, please contact PreSonus (USA) at +1 (225) 216-7887 or one of our authorized international distributors at: http://www.presonus.com/buy/international_distributors.

Product features, design, and specifications are subject to change without notice.

Added bonus: PreSonus' previously Top Secret recipe for...

Andouille & German Red Cabbage Po-Boys

Ingredients:

- 1 small Onion
- 3 Tbsp. fresh Ginger
- 1 small head Red Cabbage
- 1 tsp Salt
- 3 Tbsp. Honey
- ¼ cup Red Vinegar
- 12 oz Andouille or Bratwurst Sausage sliced lengthwise
- ¼ lb. Muenster Cheese
- Creole or German Mustard to taste
- 1 loaf French Bread

Cooking Instructions:

1. Heat 2 tablespoon vegetable oil in large skillet. Add onions and ginger, then cook them for about 3 minutes until onions begin to wilt. Add cabbage, vinegar, and honey, and then cook for about 5 minutes. Add salt to taste and set aside.
2. Heat oil in a skillet till hot. Add sausage cut side down till nice and brown, turn and cook for about 5 minutes till thoroughly cooked.
3. Slice bread lengthwise, lay a bed of cabbage, then sausage, and cheese on top. Toast under the broiler or in a hot oven till cheese is melted and bread is crisp.
4. Spread mustard on bread. Sandwich can then be cut into 2-3 pieces and shared (or not if you're really hungry).

BONUS: Extra cabbage can be used as a condiment with meat, eggs, sandwiches, etc.

NSB-Series Stageboxes

AVB Remote I/O

Owner's Manual

