



User's Manual

Video Controller NovaPro HD

Rev1.4.3 NS160100352

Statement

Welcome to use the product from Xi'an NovaStar Tech Co., Ltd. (hereinafter referred to as "NovaStar"). It is our great pleasure to offer this manual to help you understand and use the product. We strive for precision and reliability during the compilation of this manual, and the content of this manual are subject to change without notice. If you have any problem in use or you have any suggestion, please feel free to contact us according to the contact information provided in this manual. We will do our utmost to satisfy your needs. We would like to express our sincere thanks to your suggestions and make assessment for adoption as soon as possible.

Copyright

All the intellectual property rights involved in this document are reserved to NovaStar. Unauthorized duplication is a violation of applicable laws.

Trademark

 is the trademark of NovaStar.







Contents

| | | |
|-------|---------------------------------------|----|
| 1 | Safety Statement..... | 1 |
| 2 | Overview..... | 2 |
| 3 | Appearance..... | 3 |
| 3.1 | Front Panel..... | 3 |
| 3.2 | Rear Panel..... | 5 |
| 4 | Signal Connection | 6 |
| 5 | Description of Operation Modes..... | 8 |
| 6 | Machine Operation | 9 |
| 6.1 | Description of operation action | 9 |
| 6.2 | Main Interface..... | 10 |
| 6.3 | Step 1: Input Settings..... | 11 |
| 6.4 | Step 2: Screen Settings..... | 12 |
| 6.5 | Step 3: Brightness Control..... | 15 |
| 6.6 | Step 4: Output Settings | 15 |
| 6.7 | Display Control..... | 19 |
| 6.8 | Advanced Settings | 20 |
| 6.8.1 | Picture in Picture (PIP)..... | 21 |
| 6.8.2 | Advanced Configuration..... | 22 |
| 6.8.3 | Montage | 25 |
| 6.8.4 | Load Cabinet File | 26 |

| | | |
|--------|---------------------------------------|----|
| 6.8.5 | Alarm Threshold Settings | 29 |
| 6.8.6 | Advanced Property | 29 |
| 6.8.7 | Save parameters to hardware | 30 |
| 6.8.8 | Redundancy | 30 |
| 6.8.9 | DMX512 Channel Settings | 31 |
| 6.8.10 | Factory Reset | 32 |
| 6.8.11 | Hardware version | 32 |
| 6.9 | Communication Settings | 32 |
| 6.10 | Language Settings | 33 |
| 7 | Web Interface Operation | 34 |
| 7.1 | Network Establishment | 34 |
| 7.2 | Operating Motion Description | 34 |
| 7.3 | My Device | 36 |
| 8 | LCT Client Operation | 37 |
| 9 | Firmware Upgrade | 38 |
| 10 | Troubleshooting and Precautions | 41 |
| 11 | Technical Specifications | 43 |
| 12 | Installation Dimensions | 45 |

1 Safety Statement

To avoid potential hazards, please use this equipment according to the regulations. In case of damages, non-professionals are not allowed to disassemble it for maintenance without permission. Please contact the after-sales department of the company.

| | |
|---|--|
|  | <p>High voltage danger: The operating voltage of this product is 100-250V AC.</p> |
|  | <p>Grounding: This product is grounded through grounding cord of power supply. Please keep the grounding conductor is well grounded.</p> |
|  | <p>Electromagnetic interference: Keep this product far away from magnets, motors and transformers.</p> |
|  | <p>Moisture proof: Keep the equipment in a dry and clean environment. In case of liquid immersion, please pull the power plug immediately.</p> |
|  | <p>Keep away from flammable and explosive hazardous substance.</p> |
|  | <p>Prevent liquids or metal fragments from being immersed into the product in order to avoid safety accidents.</p> |

2 Overview

NovaPro HD is a professional LED display controller. Besides the function of display control, it also features in powerful front-end processing. It has integrated various professional interfaces. With excellent image quality and free image control, NovaPro HD has greatly satisfied the requirements of display industry.

Product features:

- 1) NovaPro HD has complete input interfaces including CVBS, VGA, SDI, DVI, HDMI and DP. These interfaces support input resolution up to 1080p@60Hz, highest pixel clock up to 165 MHz and output bandwidth up to 4 GBit.
- 2) NovaPro HD has adopted 12 Bit digital processing internally. With advanced de-interlacing motion self-adaptive processing technology adopted, images are clear and fine. Each input can be fully configured with contrast, saturation, hue, color temperature. It allows for switching between point-to-point display and point-by-point scaling of input image according to display resolution.
- 3) NovaPro HD doesn't need computer software for system configuration. System configuration can be completed only through one knob and one button. All operations can be done only by several steps. That's what we called "Touch Track" .
- 4) NovaPro HD supports multiple units splicing.
- 5) NovaPro HD has integrated DMX512 and GenLock input and loop interfaces. Professional control and synchronization have been provided. With the design of

dual power redundancy backup, the system is stable and reliable. Optical fiber output has guaranteed the stability of long-distance data transmission.

- 6) In addition to the operations of the controller and LCT client, you can also configure the system with browsers on your PC or PAD, namely, Web interface operation which is able to preview and assist with system settings in real time and confirm current working status of the system.
- 7) NovaPro HD is the flagship product of NovaStar new generation controllers. Being powerful in image processing, professional in image control and friendly in user-interface, NovaPro HD has brought unprecedented ease and pleasure in LED display control.

3 Appearance

3.1 Front Panel



① : Power switch

② : Power switch indicators

Green indicator: Indicates device working status.

- Flashing normally: The device works normally.

- Flashing slowly: There is no video signal.
- Breathing: One or more Ethernet ports are in hot backup mode.

Red indicator: Indicates device power status.

③: Input source buttons and indicators.

Press the input source button to set the input source for main picture. Hold down the button to set the input source for PIP. You can view the operation result on the operation screen during setting.

The indicator is blue by default. It turns to green when the current input source is selected.

④: Operation screen (Please see details in the subsequent Chapter: Main Interface).

⑤: **Knob**: Enter by pressing the knob and select or adjust by turning the knob.

⑥: **ESC**: Exit current operation or option.

⑦: **BLK**: LED Display is blank screen. Indicator light is blue by default after power on and it turns green when BLK is enabled;

FRZ: Images on LED Display are frozen. Indicator light is blue by default after power on and it turns green when enabled;

PIP: Display PIP. Indicator light is blue by default after power on and it turns green when enabled;

⑧: Type A female interface is USB interface to connect U disk to import configuration file or update programs.

Type B female interface is USB control interface to connect PC for communication.

3.2 Rear Panel



Note: In order to improve user' s experience, layout of the interfaces may be adjusted a little. The picture is only for reference.

| Inputs | |
|--------------|--|
| Audio | Audio Input |
| DP | DP Input |
| HDMI | HDMI Input |
| DVI | DVI Input |
| VGA | VGA Input |
| CVBS | PAL/NTSC TV Composite Video Inputs |
| 3G-SDI IN | 3G-SDI Input |
| Genlock IN | Synchronizing signal to guarantee the images on display is synchronous with external Genlock source. |
| Outputs | |
| 3G-SDI LOOP | 3G-SDI loop output |
| GenLock LOOP | Genlock loop output |
| DVI LOOP | DVI loop output |
| Monitor -DVI | Monitoring connector |

| | |
|--------------------------|--|
| Monitor -HDMI | |
| LED Out 1, 2, 3, 4 | 4 Ethernet port outputs Only Ethernet port 1 supports audio output. When the multifunction card is connected for audio decoding, the multifunction card must be connected to the Ethernet port 1. |
| OPT Output 1, 2, 3, 4 | 4 optical fiber outputs |
| Control Interface | |
| ETHERNET | Ethernet Control (connecting PC for communication or accessing Network) |
| USB Control | IN: connecting PC for communication or cascade input; connecting USB OUT of last NovaPro HD |
| | OUT: cascade output, Cascading USB IN of next NovaPro HD |
| DMX Control | IN: connecting all consoles that support DMX512 interface protocol. |
| | LOOP: DMX512 signal Loop output |
| Power | |
| AC 100-250V~50/60Hz | AC Power Interface |

4 Signal Connection

Signal Connection

Connect the required hardware devices referring to the interface descriptions in previous chapters.

Note: Please turn OFF POWER before signal connection.

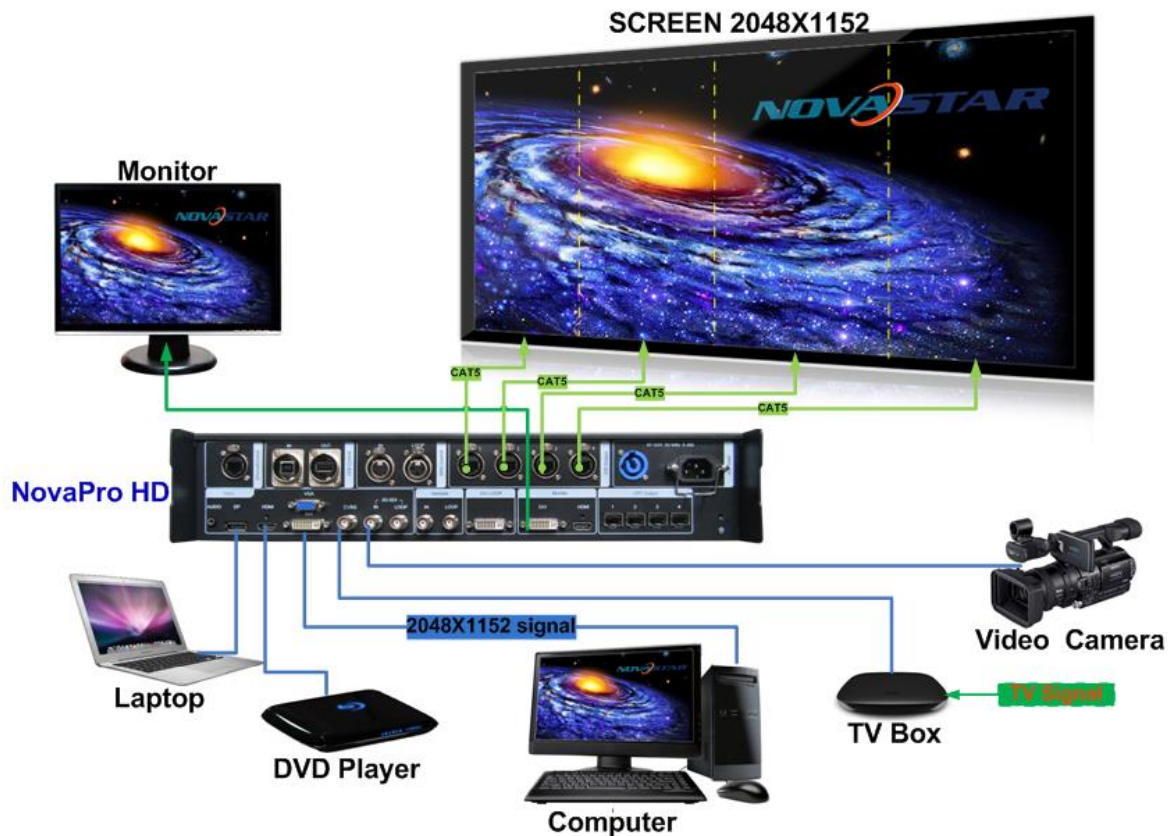

Fig. 4-1 Signal Connection

Multiple Units Connection Sketch

Video Source Connection

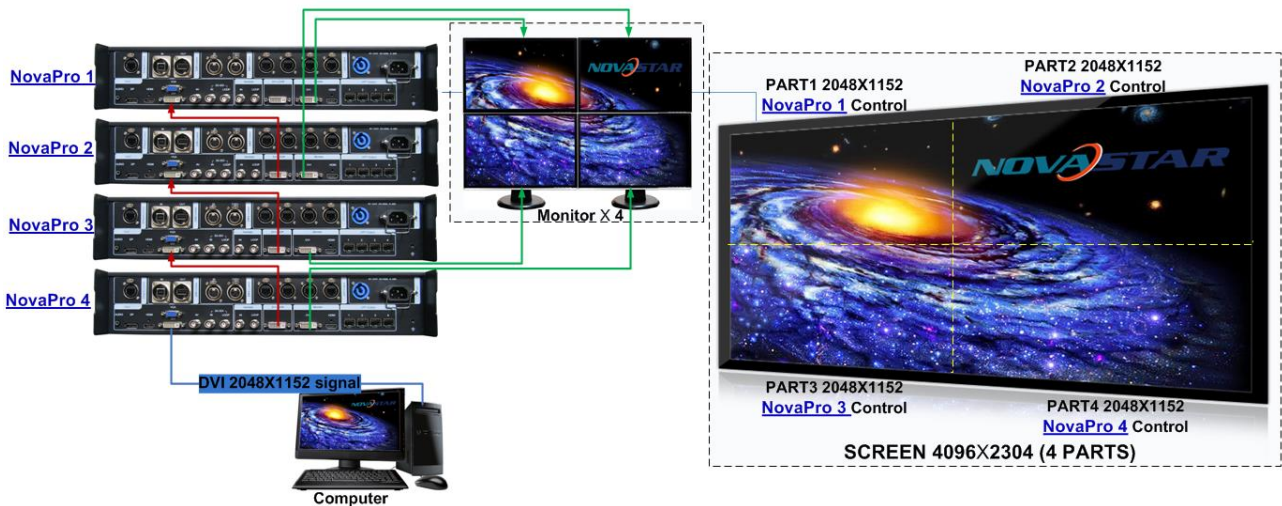

Fig. 4-2 Oversized Video Source Loading Scheme (4K)

Cascade Control Signal Connection

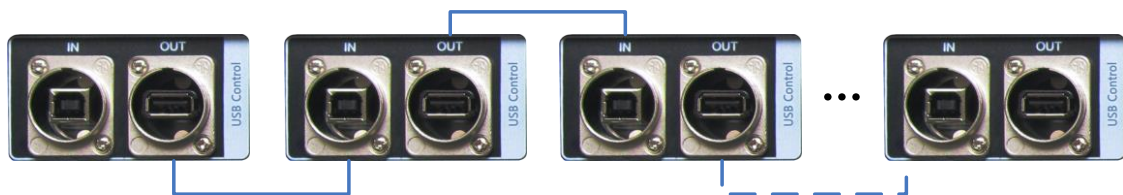

Fig. 4-3 Cascade Control Signal Connection

5 Description of Operation Modes

NovaPro HD is not only powerful in functions but also easy to use. It supports three operating modes for users to choose in different occasions.

Mode 1: Machine operation. All operations can be completed by a knob and a button on NovaPro HD without PC.

Mode 2: Web operation. Suitable for the situation when NovaPro HD and control computer are in the same LAN. Open up a browser on control computer and enter the IP of NovaPro HD to log in control page.

Mode 3: NovaLCT client operation. Connect NovaPro HD to control computer and all configurations can be completed on NovaLCT-Mars client. Then send to NovaPro HD.

Note: Interlace operation of machine, LCT and Web is not allowed.

Please refer to the following chapter for detailed operation steps.

6 Machine Operation

LED display can be started with moderate brightness and used normally through five simple steps.

Menus of Display Control, Advanced Settings, Communication Settings and Language can help users to better control LED display.

6.1 Description of operation action

Knob: Press the knob to enter into menu and turn it to adjust values or select submenus. At this time, enter into the submenus or confirm adjusted values by pressing the knob.

【ESC】 : Return key, exit from current menu or operation.

Option buttons of six input sources: Short press a button to set it as the input source of main screen while long press to set as the source of PIP.

Lock: simultaneously press the knob and ESC button for more than three seconds to lock the controller.

Unlock: simultaneously press the knob and ESC button for more than three seconds to unlock the controller.

6.2 Main Interface

After starting the controller, the main interface of LCD display is as follows:

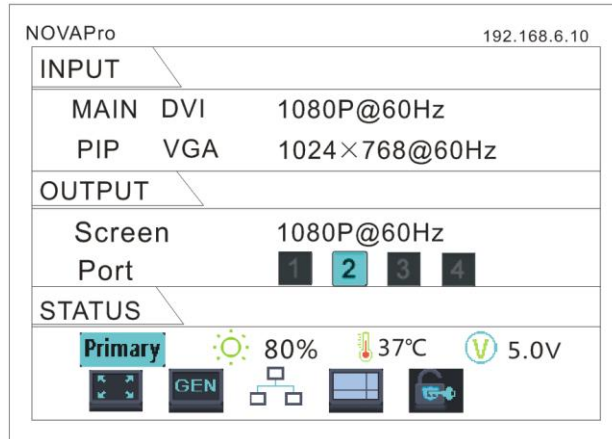

First row: product model, local IP/ device name (custom)

INPUT:

Main screen, signal source, input source signal format.

PIP, signal source, input source signal format.





OUTPUT:











Output signal format of LED display.

LED Output, Currently it is Port2 output.

STATE:

Status bar, meanings of each icon are described as below:

| | |
|--|--|
|  | It denotes that the controller is in primary control mode. |
|  | It denotes that the controller is in backup mode. |
|  80% | Current brightness is 80%. |
|  37°C | When the temperature of NovaPro HD exceeds threshold value (able |

| | |
|--|---|
| | to be changed by users), the temperature value will turn red and blinks. |
|  5.0V | When the voltage of NovaPro HD exceeds threshold value (able to be changed by users), the voltage value will turn red and blinks. |
|  | Current effect is point-to-point display. |
|  | Scaling down mode |
|  | Scaling up mode |
|  | It denotes that there is Genlock synchronous signal input. |
|  | It denotes that DMX channel signal is enabled. |
|  | It is USB control currently. |
|  | It is Ethernet Port control currently. |
|  | Image Mosaic enabled |
|  | Button lock icon, functions of the buttons and knob are locked when this icon appears on the main interface. |
|  | It denotes that the controller is not locked |

6.3 Step 1: Input Settings

Set the resolution of input source signal. Resolution can be directly set and changed through NovaPro HD for digital input modes: DVI, HDMI and DP. For other input modes, resolution can only be changed on input devices.

Input resolution can be set through two ways:

I: Preset Resolution

Choose a suitable resolution from the standard resolutions preset in the controller. If there is no suitable resolution, please go to II: Custom Resolution

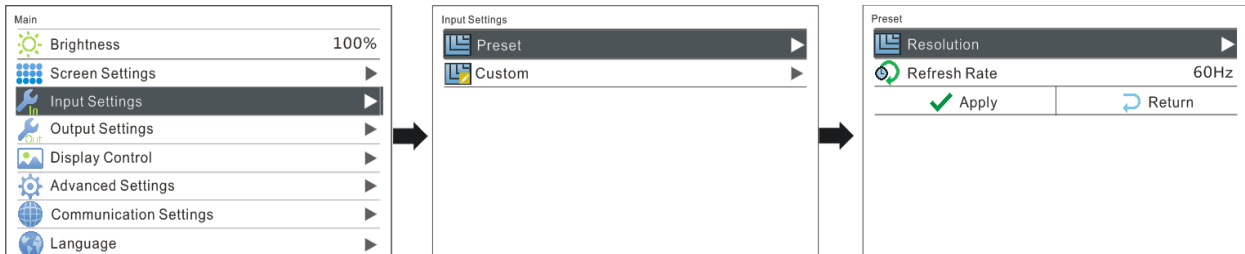

II: Custom Resolution

Set custom width, height, refresh rate. Then turn the knob to select "Apply" and press the knob to confirm and apply. If not confirmed, the custom resolution settings will be unavailable.

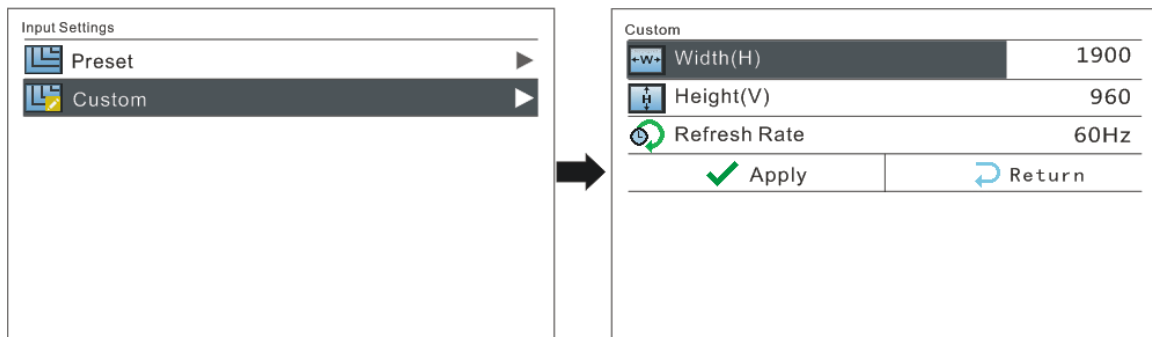

6.4 Step 2: Screen Settings

Preconditions of screen settings:

- 1) Each Ethernet port must load the same number of cabinets (If the number of cabinets is not integer multiples of the Ethernet ports, the remaining cabinets will be loaded by the last Ethernet port);
- 2) Regular screen, regular cabinets, each cabinet with the same size.

Operating steps of screen settings:

Step 1 Turn on the power of LED display. If the cabinets display normally, go to step

2. If the cabinets display abnormally, it is required to load the cabinet file first and save it to receiving card. Please see detailed operations in [Advanced Settings](#).

Step 2 Enter into the submenu of "**Screen Settings**" submenu. The options are shown

in the following figure:

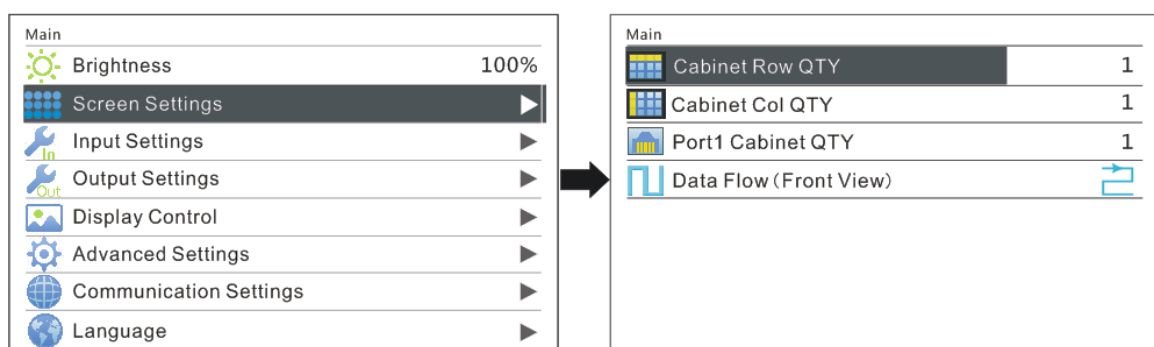

Step 3 Set Cabinet Row QTY and Cabinet Column QTY according to the actual situation of the screen.

Step 4 Set Port1 Cabinet QTY. The device has some limitations on the cabinet quantity of network interfaces. For details, see precautions for screen setting a). The controller has certain limitations to the quantity of cabinet loaded by an Ethernet port. Please see details in Notes a) of Screen Settings.

Step 5 Set data flow of the screen and please see the Notes c), d), e) of screen settings.

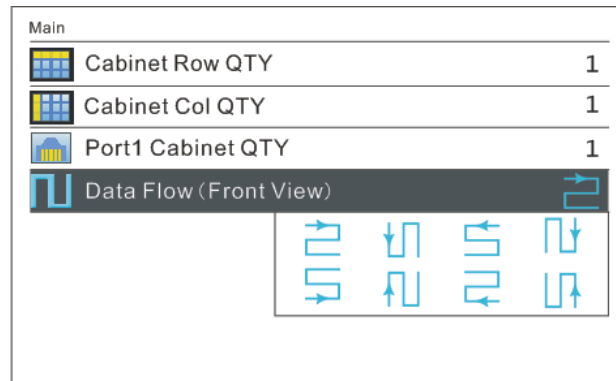

Notes for screen settings:

a) If the number of ports with loads is n ($n \leq 4$), the quantities of cabinets loaded by each of the first $n-1$ ports must be equal (If the quantity of cabinet loaded by each port are different, please choose **Advanced Config** and view details in **Advanced Configuration**) and also be an integral multiple of the quantities of cabinet rows or columns and, meanwhile, be greater than or equal to the quantities of cabinets loaded by the n th port.

Example:

If Port 1, Port 2, Port 3 have loads, cabinet quantity of Port 1 and Port 2 must be equal and also be an integral multiple of the quantity of cabinet row or column. As a result, set Port 1 Cabinet Qty only according to actual situation during screen settings. The quantity of receiving card loaded by Port 3 \leq the quantity of cabinet loaded by Port 1.

b) In case of special-shaped cabinets, cabinets with different size and special-shaped screen, the software NovaLCT-Mars is required to be connected to configure the screen.

c) During Data Flow setting, turn the knob to see the results of different types of data flow on the screen in real time. If satisfied with the current data flow, you must press the knob to save the setting. Press return key to exit from current operation.

- d) During Data Flow setting, make sure that the data flow of each port is connected along the same direction.
- e) During Data Flow setting, make sure that the start position of Port 1 is the start position of whole data flow connection.

6.5 Step 3: Brightness Control

Return to main menu interface. Press the knob and select the corresponding value. At this time, the knob can be turned to adjust brightness value.

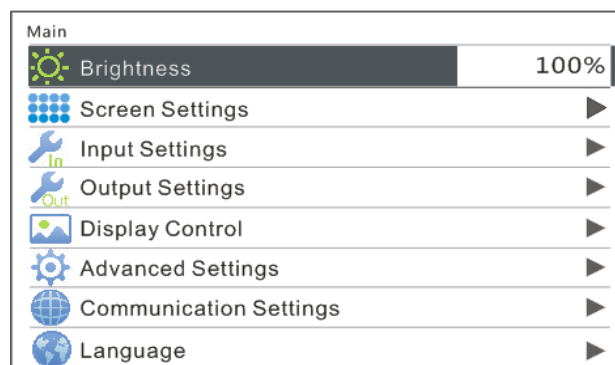

6.6 Step 4: Output Settings

Output settings can be divided into three cases:

- I: Point-to-point display, namely, scaling disabled. Size of output image is the same as input image and the output is based on original proportion.

Horizontal and vertical offset of image are set as required and operation steps are shown in the figure below.

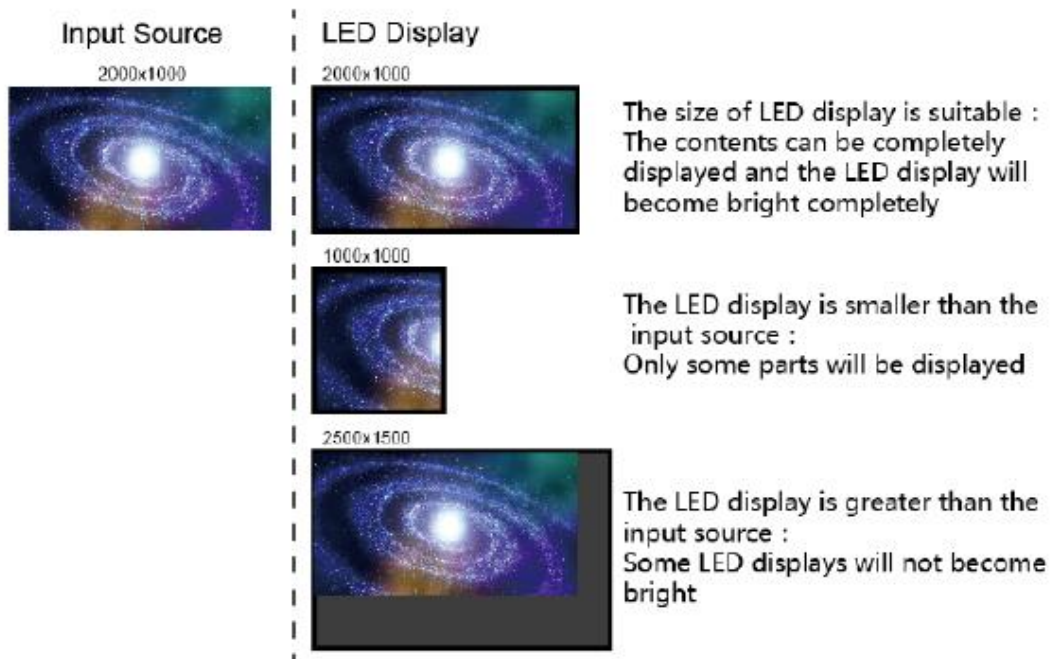
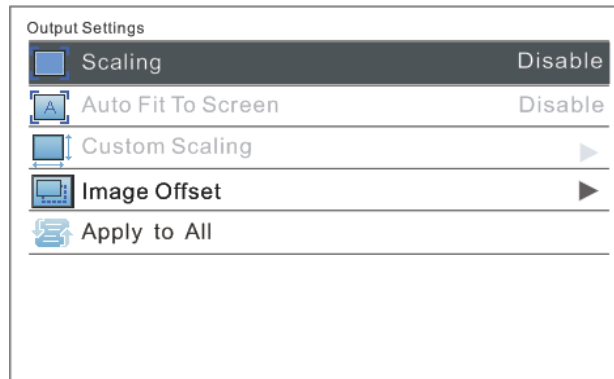

Effects of scaling disabled

- II: Output image is adjusted to the size of display screen, namely it is self-adaptive to the size of display screen.

Operation: Enable scaling and auto fit to screen.



➤ III: Custom Scaling

Operation: Enable Scaling and disable Auto Fit To Screen to customize scaling.

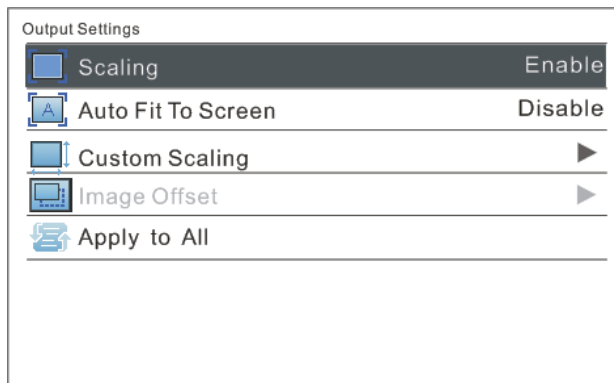

Operating steps of custom scaling:

- a) Input Capture setting, i.e., to capture the part of the image from one start position of the input image and display it on the LED screen. It is needed to set horizontal width (\leq horizontal resolution of input source) and vertical height (\leq vertical resolution of input source) as well as start X (horizontal start) and start Y (vertical start).

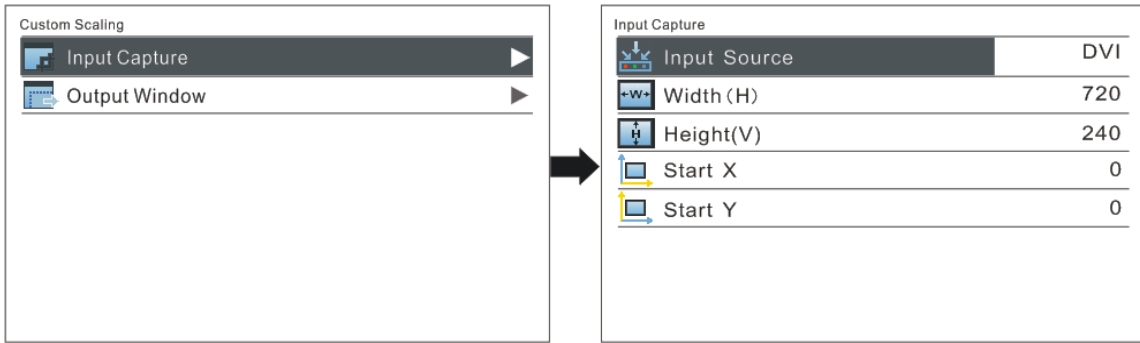

- b) Output Window setting, size of the window is smaller than or equal to the size of LED display. After window is set, images can only be displayed within the range of the window and be self-adapted to the size of the window.

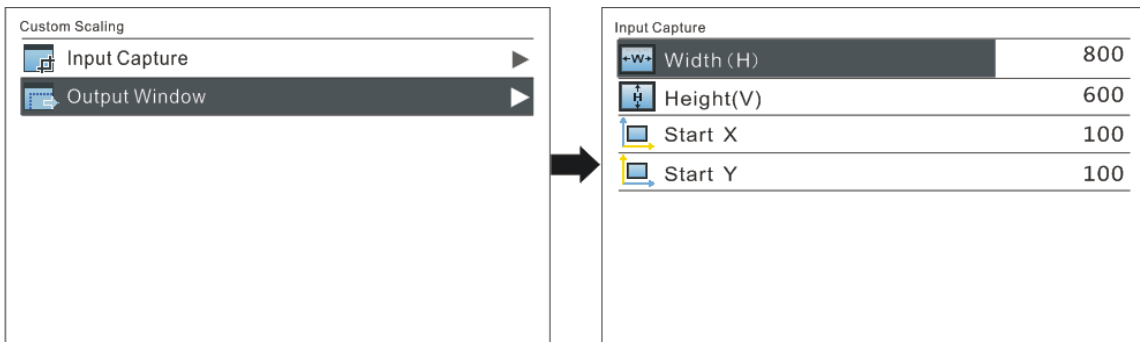

After setting according to the above two steps, the captured content will be only displayed on the set area of the LED display, as shown below:

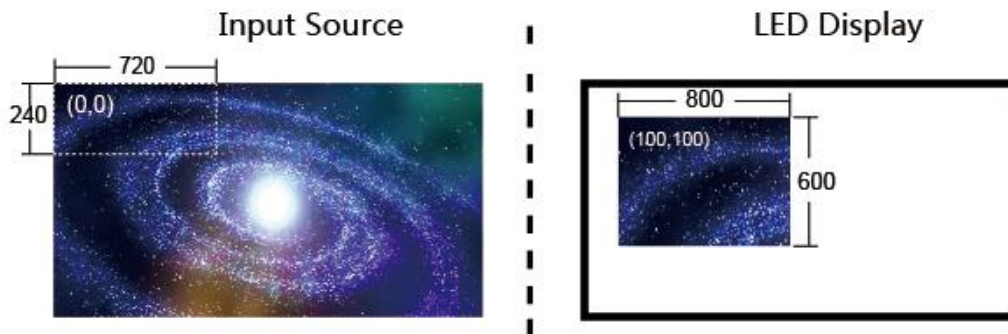

Custom Scaling Effect

6.7 Display Control

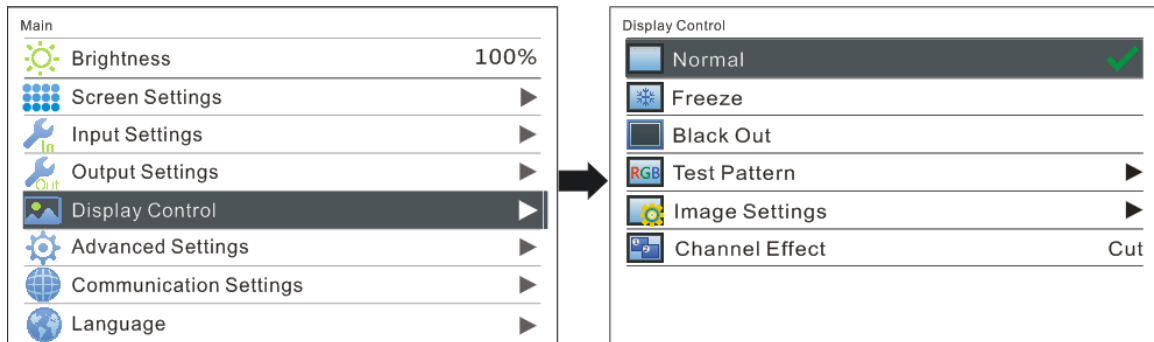

- **Normal**
- **Freeze:** same as the function of FRZ button.
- **Black Out:** same as the function of BLK button.
- **Test Pattern**

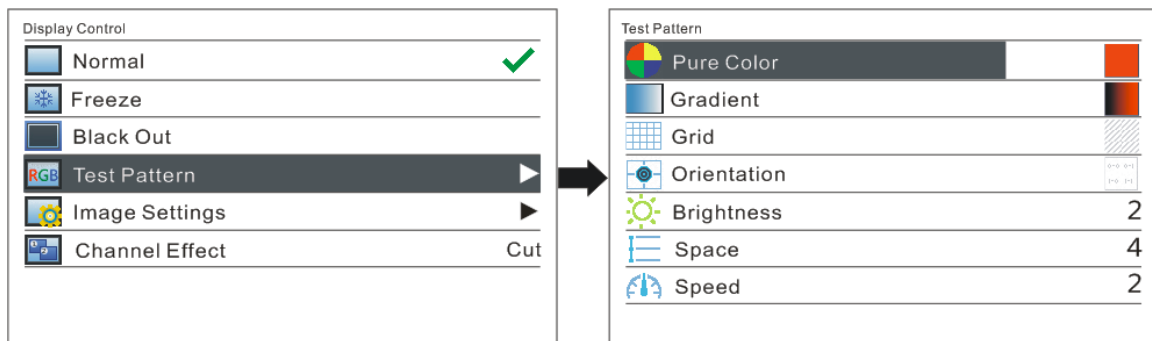

- **Picture quality adjustment**

Set contrast, saturation, hue, sharpness, color temperature, red brightness, green brightness, blue brightness and Gamma as required. Save these parameters to hardware after adjusting to satisfaction

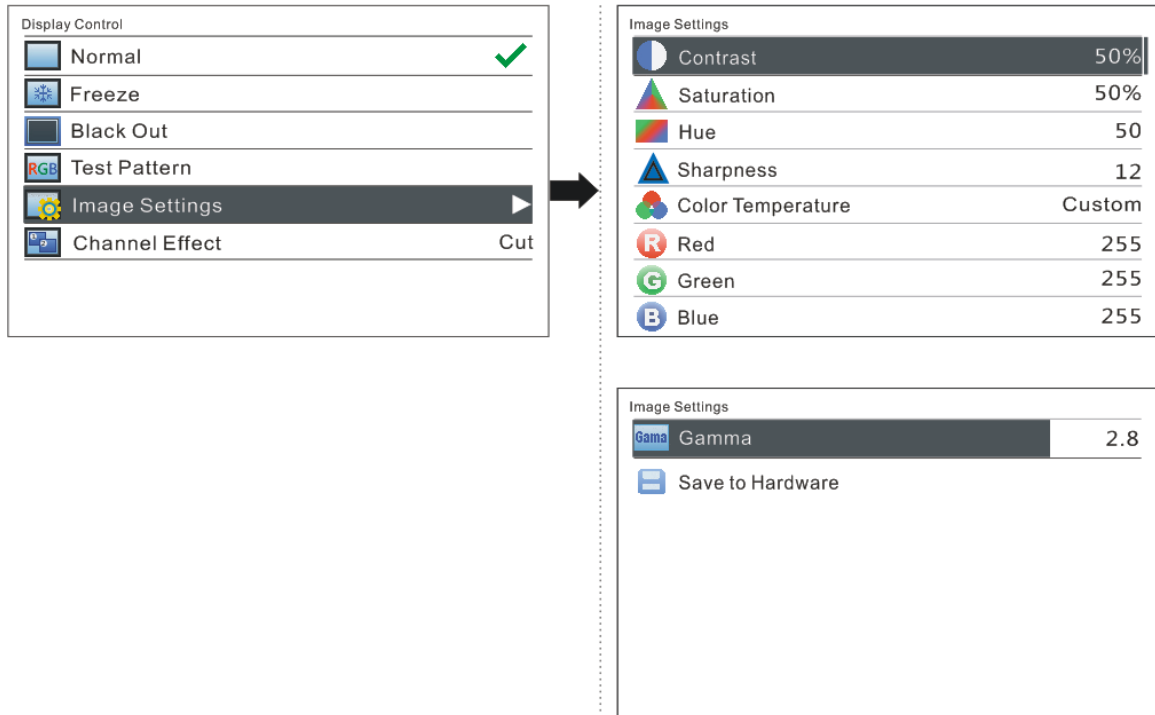

➤ Channel Effect

The software supports three effects: cut, fade and pop-up. Select Off to if off to switch off Channel Effect.

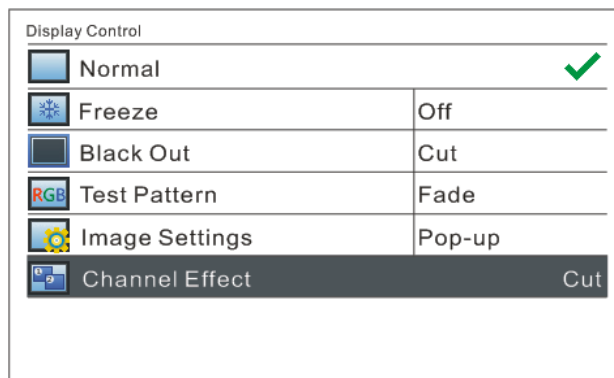

6.8 Advanced Settings

Several options of major function setting are included in advanced settings, as shown in the figure below, including PIP, Advanced Configuration, Montage, etc. Operation of each function will be detailed for users in the following chapter.

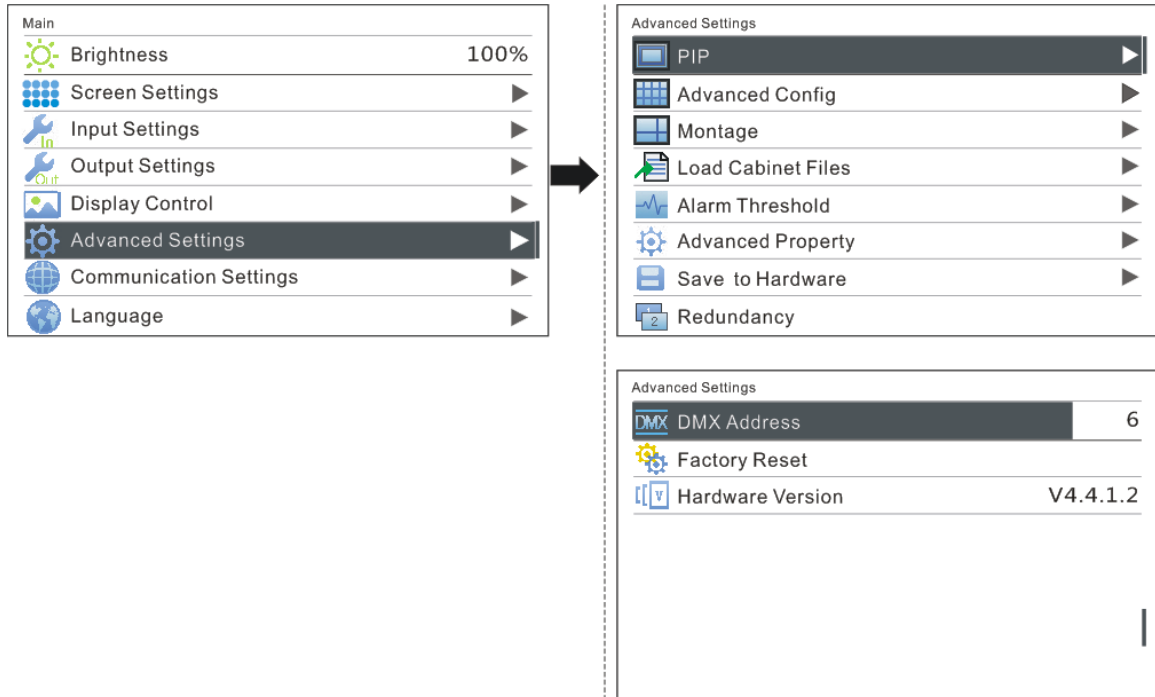

6.8.1 Picture in Picture (PIP)

To switch on or off PIP and set the input source of main screen as well as the size, position and transparency of PIP and PIP crop settings.

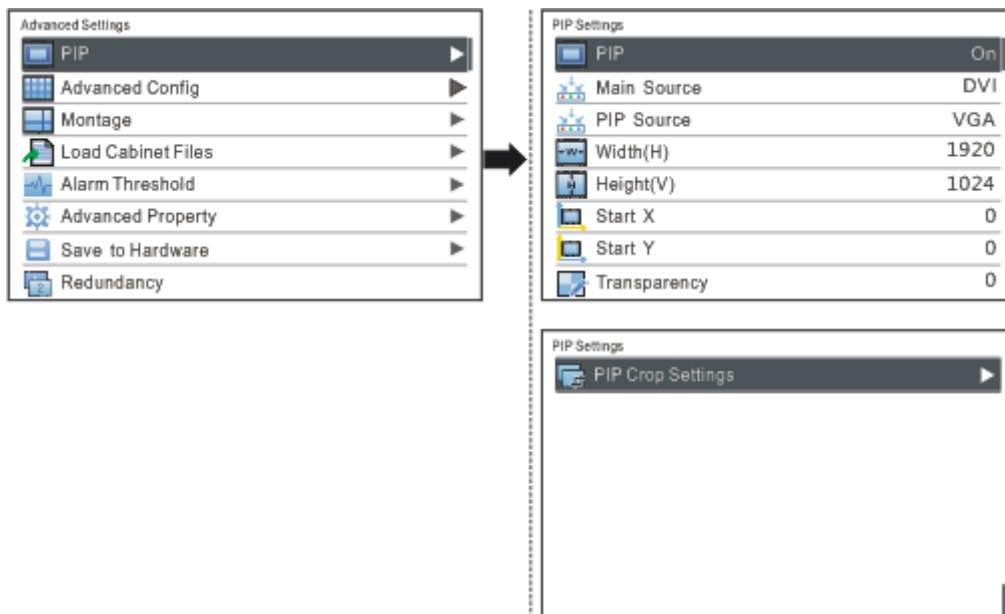

PIP: Switching on/off PIP is the same as the function of PIP button on front panel and

synchronous with it.

Main source/PIP source: Input source switching of main screen and PIP is the same as the function of input source switching button on front panel.

Width (H): Horizontal width of PIP

Height (V): Vertical height of PIP

Start X: Horizontal coordinates of PIP

Start Y: Vertical coordinates of PIP

Transparency: Transparency of PIP

PIP Crop Settings:

Image cropped from the set starting position will be displayed on PIP and its size is the set horizontal width and vertical height.

Please enable this function before setting horizontal width, vertical height, start X and start Y.

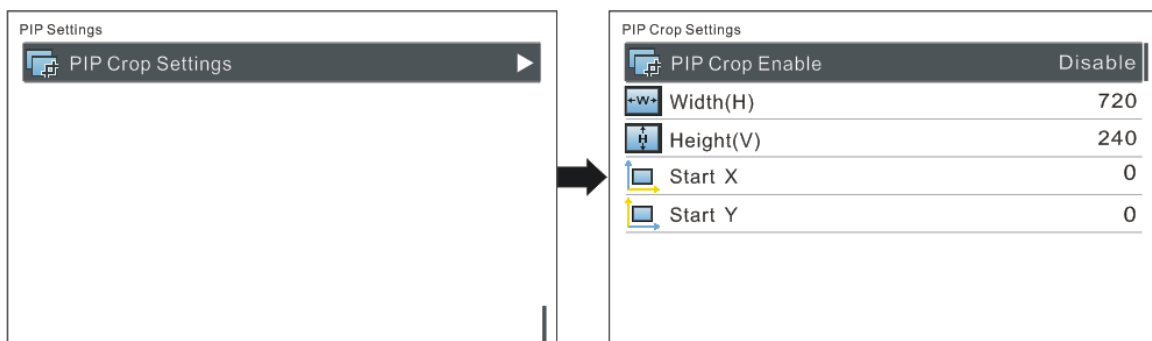

6.8.2 Advanced Configuration

If the number of cabinets loaded by each Ethernet port is different and the preconditions of screen settings are not met, advanced configuration can be used now.

Operating steps of advanced configuration are shown as below:

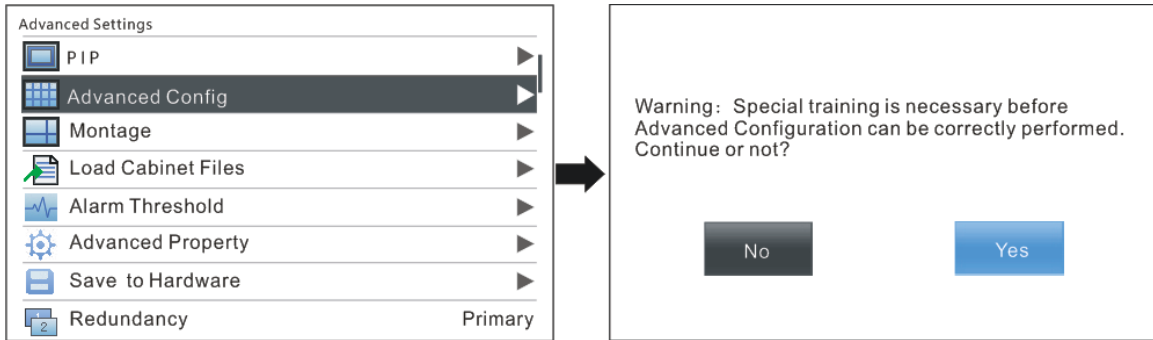

1) Enable Advanced Config

Please enable Advanced Config first since it is disabled by default in NovaPro HD.

Advanced Config defaults to "Disabled". After the function is enabled, the rows and columns of the cabinets loaded by each port, offset, and data flow can be set respectively.

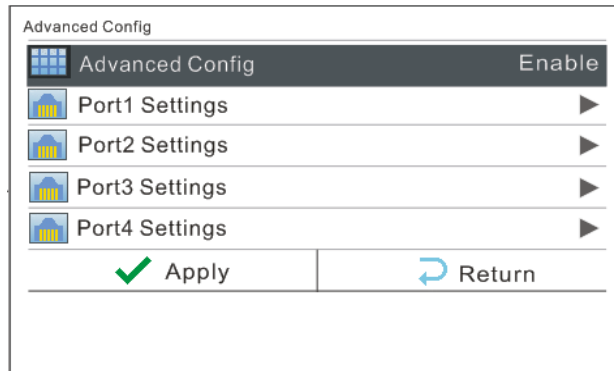

2) Ethernet Port Settings

Set the rows and columns of the cabinets loaded by each port, horizontal and vertical offset as well as data flow according to the actual layout of the cabinets.

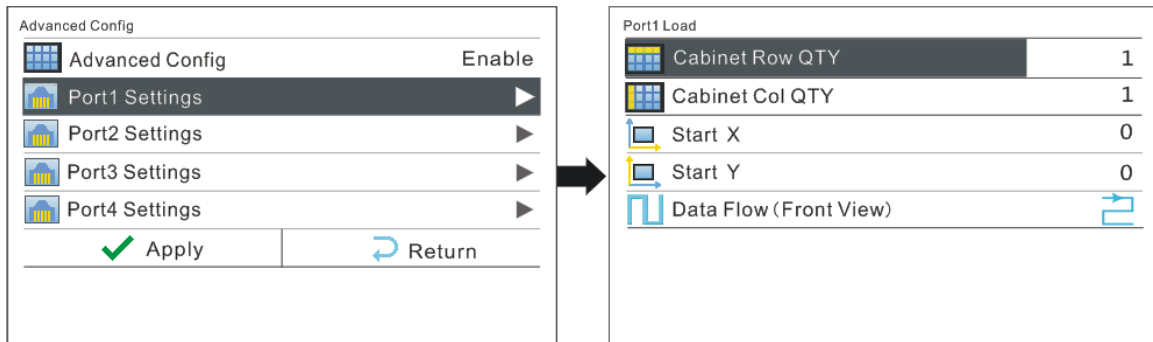

Precautions for advanced mapping screen:

- a) If the cabinets are irregular shaped and the sizes are different and the LED screen is also irregular shaped, the software NovaLCT-Mars is required to be connected to configure LED display.
- b) When wiring method is set, real-time effect of different wirings can be displayed on the display screen by turning the knob. If you are satisfied, you must press the knob once to save the setting and press return key to exit the current operation. During data flow setting, turn the knob and the results can be viewed on the LED display in real time. Press the knob to save your setting if you are satisfied with it and then press return button to exit from current operation.

After Port Settings are completed, select "**Apply**" and press the knob to apply current settings. If you want to quit the settings, select "Return" .

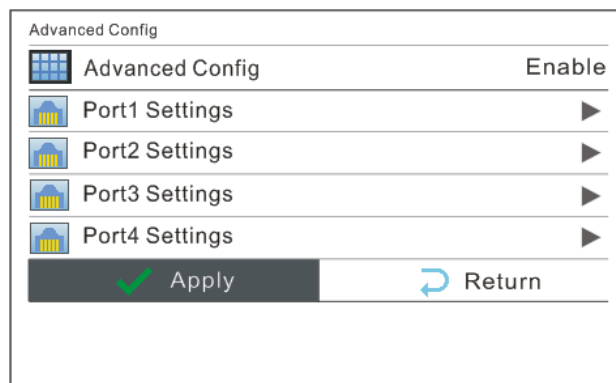

6.8.3 Montage

For oversized LED display, two or more NovaPro HD units are needed for montage. In this case, the loading area of each NovaPro HD unit needs to be set respectively.

Enable Montage first and set total width and height of the LED display. Then set the size and starting position of loading area of the NovaPro HD unit.

Total sizes of loading area of all NovaPro HD units are the total sizes of LED display.

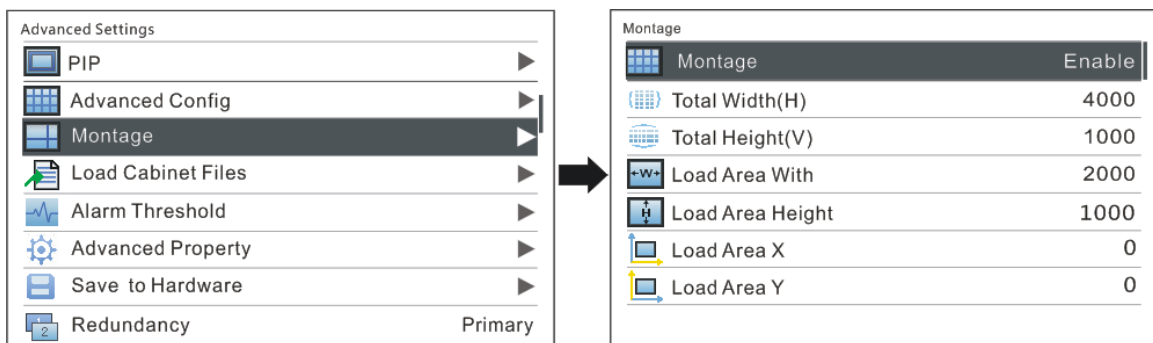

Montage Example: the total number of pixels of the LED display is 4000×1000, which has exceeded the load of a single Pro HD unit. Montage can be applied and two Pro HD units can be used for montage. See detailed parameter settings and the connections in the chart and figure below.

| | Pro HD (1) | Pro HD (2) |
|------------------|---------------|------------|
| Total Width(H) | 4000 | |
| Total Height(V) | 1000 | |
| Load Area Width | 2000 | 2000 |
| Load Area Height | 1000 | 1000 |
| Load Area X | 0 | 2000 |

| | | |
|-------------|---|---|
| Load Area Y | 0 | 0 |
|-------------|---|---|

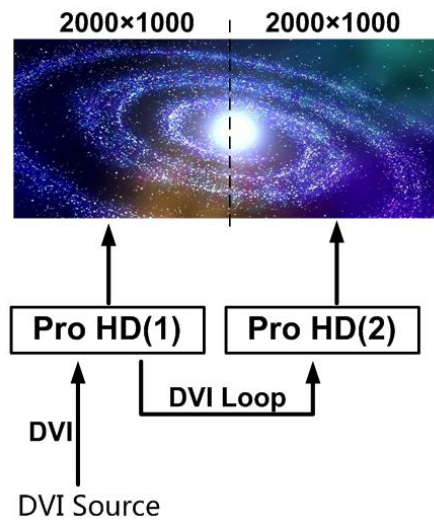

Montage Connections (referring to the Chapter: Signal Connection)

Note: If montage is to be enabled, please ensure Output Settings is in the third case: Custom Scaling, namely, set Scaling as enable while Custom Scaling as disable.

6.8.4 Load Cabinet File

Connect NovaPro HD to PC and run NovaLCT-Mars on PC. Import cabinet configuration file saved before into the controller.

1) Save cabinet configuration file

After receiving card is configured, click **Save File** to save cabinet configuration file (.rcfg) to local file on PC.

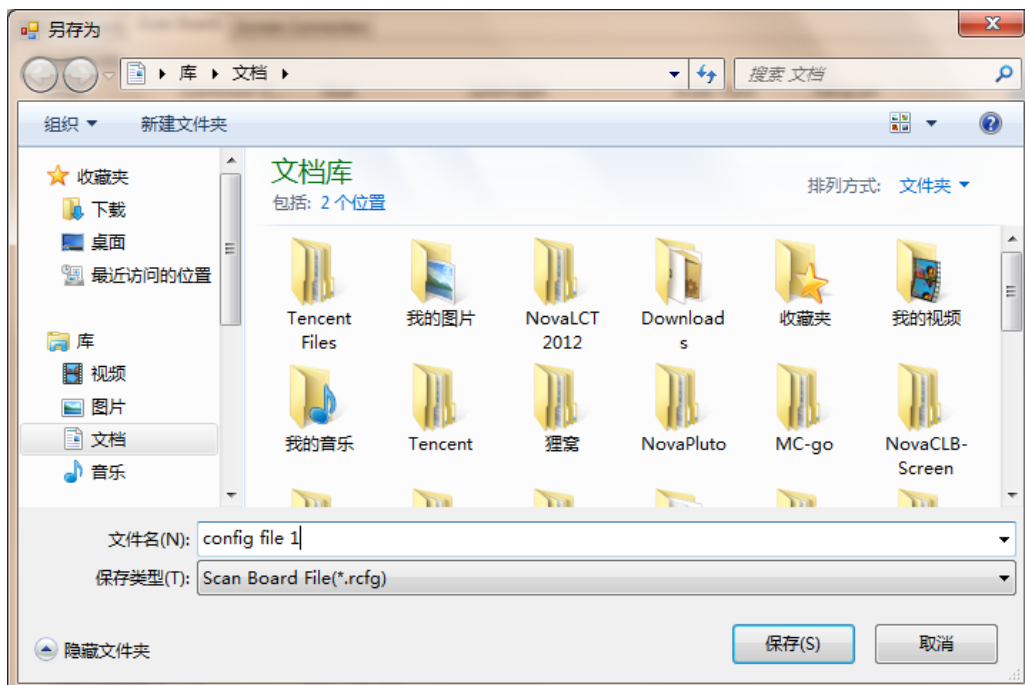
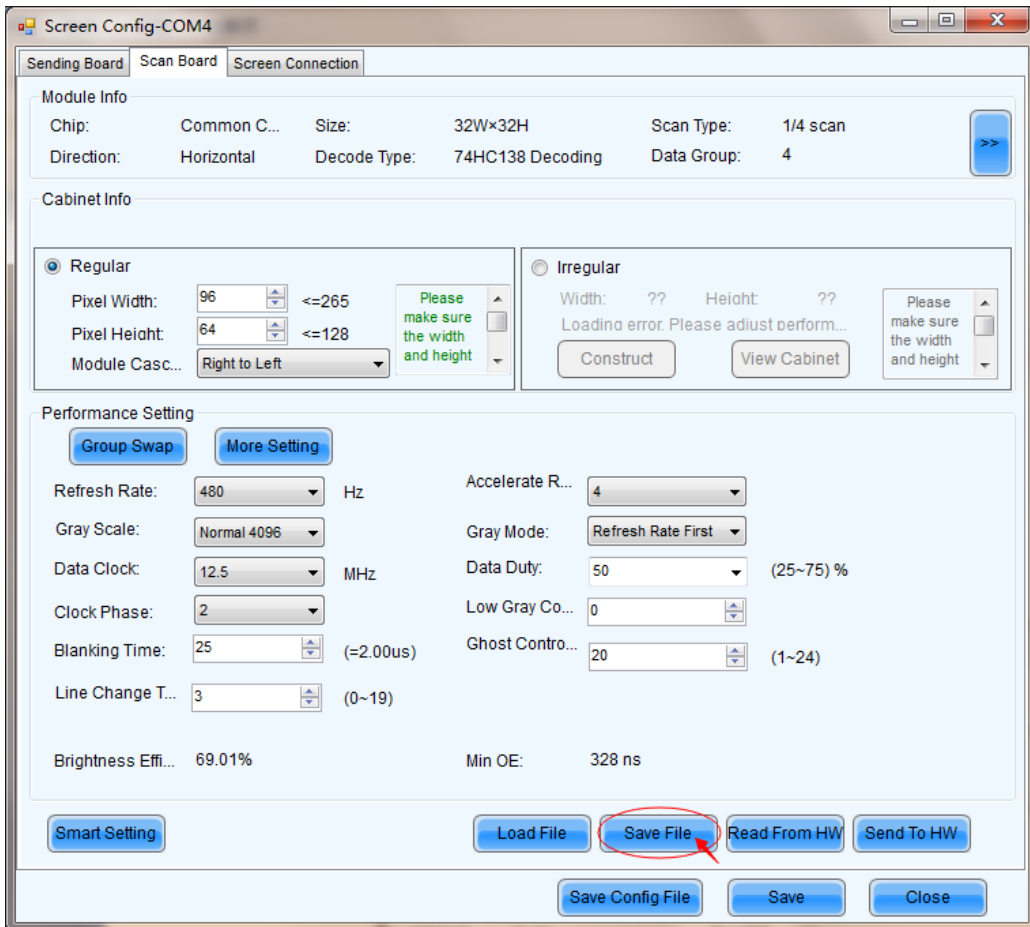

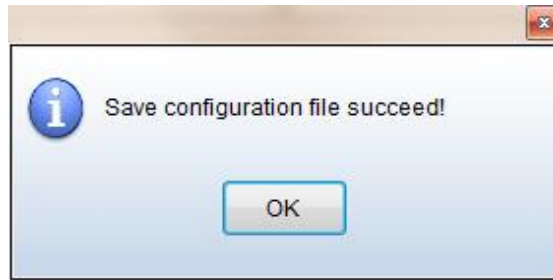

2) Import cabinet configuration file into NovaPro HD.

Operating steps are shown in the figure below:

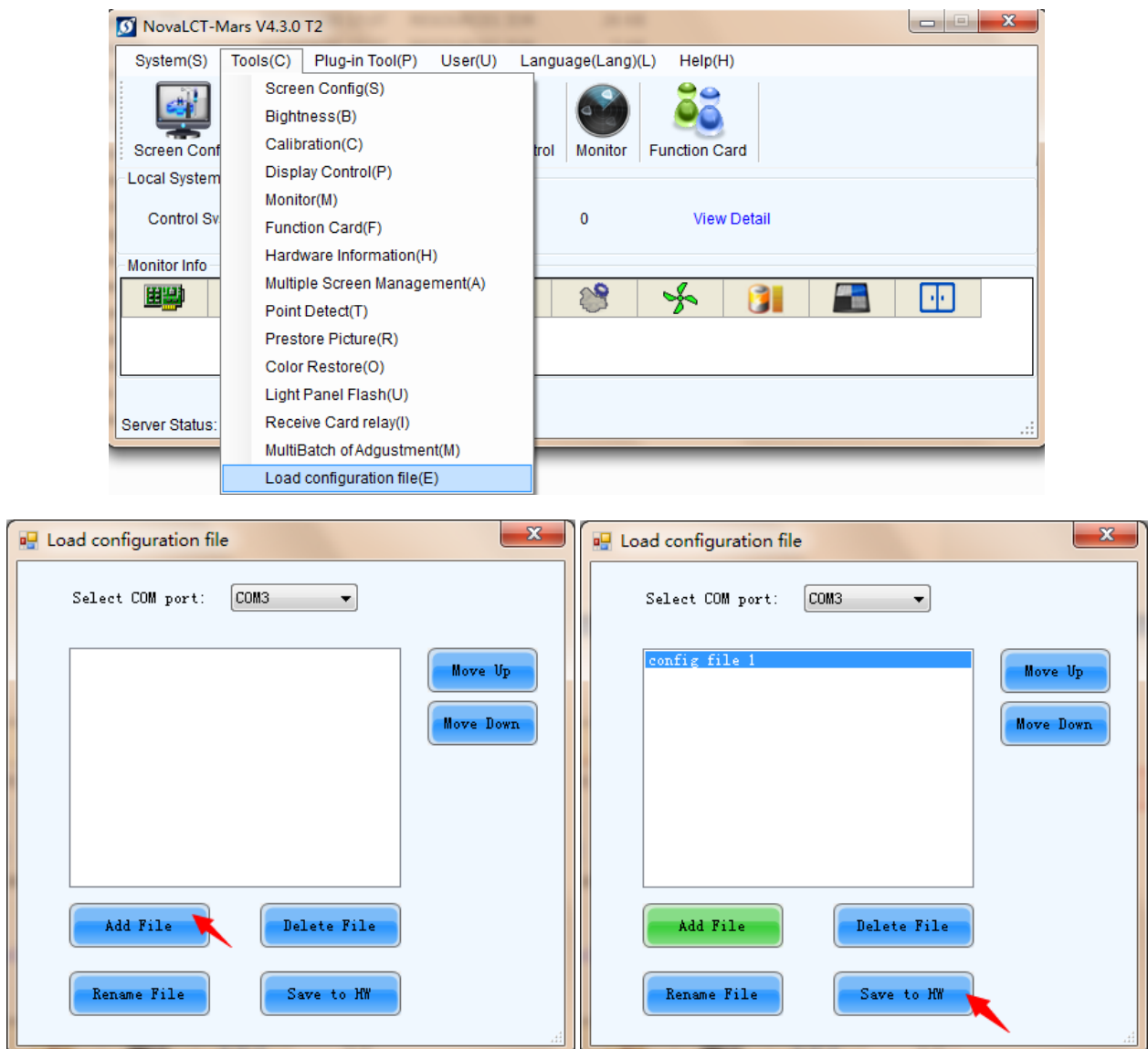

3) Load Cabinet File

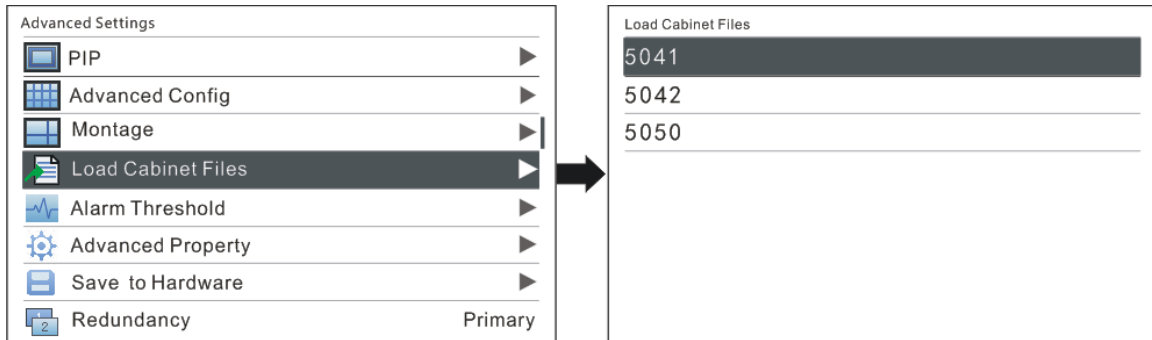

6.8.5 Alarm Threshold Settings

Set the threshold values of temperature and voltage. When temperature or voltage of NovaPro HD exceeds the threshold value, temperature or voltage on the home page of the screen will turn red and blink.

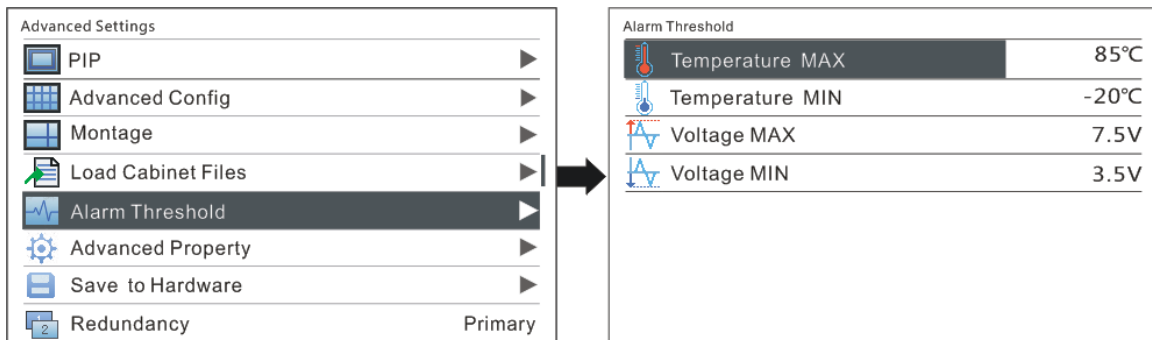

6.8.6 Advanced Property

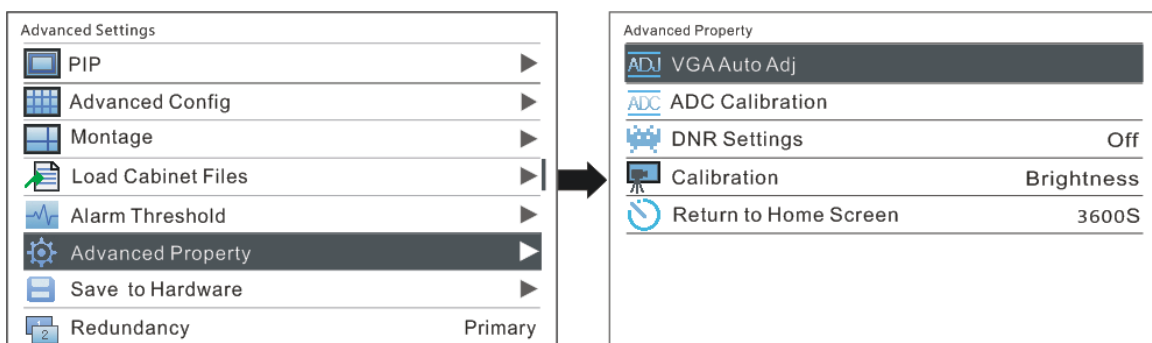

Including following functions:

VGA Auto Adj: sampling parameters of VGA input signal are automatically adjusted

so that VGA image is clear and complete. Select this menu and then press the knob once to perform VGA automatic adjustment once.

ADC Calibration: Images will be color cast or darker etc. when analog signal is accessed into processors without ADC calibration. NovaPro HD is able to automatically perform ADC calibration based on input analog signal (including CVBS and VGA) to solve above problems. Select this menu and then press the knob once to perform ADC calibration once.

DNR Settings: It is available when image input port is not VGA and there are five modes of noise reduction: "Off", "Auto", "Low", "Medium" and "High".

6.8.7 Save parameters to hardware

Save all the configurations of NovaPro HD to hardware and the data will not be lost after power off.

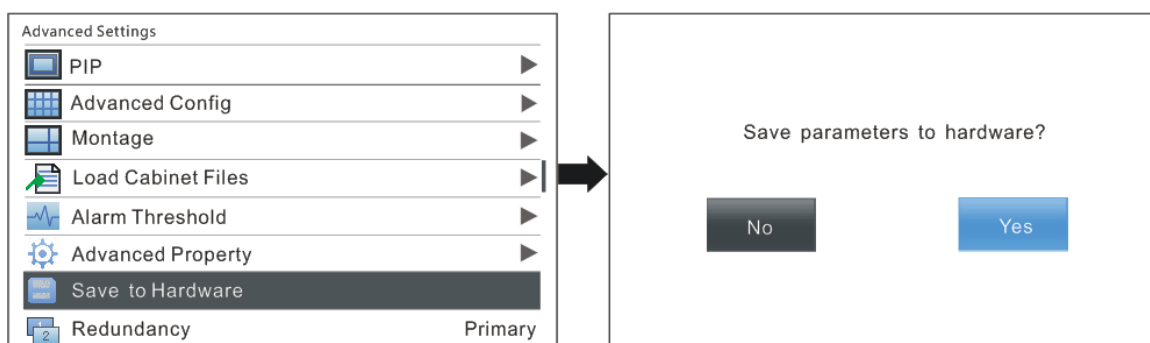

6.8.8 Redundancy

Set this controller as primary control or backup. "Primary" or "Backup" will be displayed on the main interface.

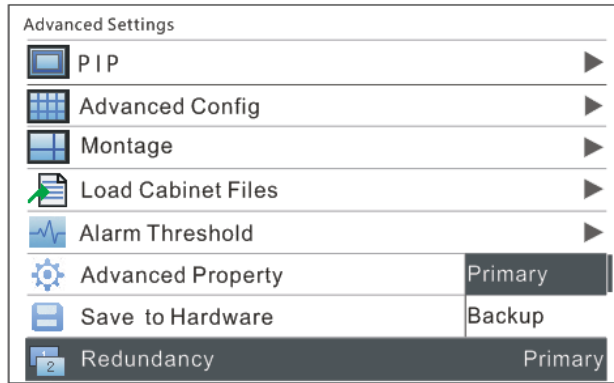

6.8.9 DMX512 Channel Settings

Set the starting channel of DMX512. NovaPro HD currently has extracted 16 property channels. 0~8 have been defined with properties and the rest are not defined for the moment.

For example, if the starting channel is set as 1, the controller will take 16 channels from the 1st channel as available channels.

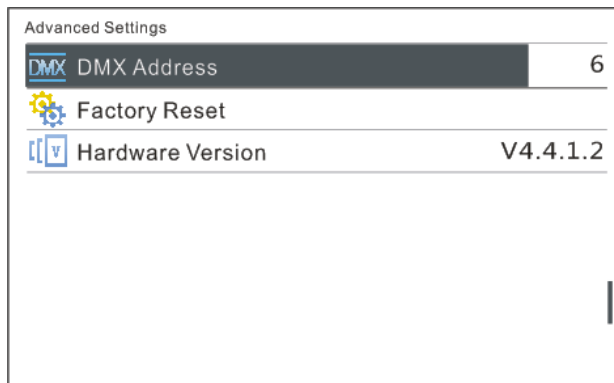

Definitions of channel properties are shown in the table below:

| Channel No. | Property Definition |
|-------------|----------------------------------|
| 0 | Global Brightness of LED display |
| 1 | Contrast |
| 2 | Saturation |

| | |
|----|----------------------------|
| 3 | Hue |
| 4 | Color temperature |
| 5 | Red component brightness |
| 6 | Green component brightness |
| 7 | Blue component brightness |
| 8 | Gamma |
| 9 | Undefined |
| 10 | Undefined |
| 11 | Undefined |
| 12 | Undefined |
| 13 | Undefined |
| 14 | Undefined |
| 15 | Undefined |

6.8.10 Factory Reset

Restore NovaPro HD to factory settings.

6.8.11 Hardware version

View hardware version of NovaPro HD.

6.9 Communication Settings

Set communication mode and network parameters of NovaPro HD.

There are two communication modes, one is USB Preferred and the other is LAN Preferred. If both USB and LAN port are connected to control computer and LAN Preferred is selected, system will use LAN to control. If only USB port is connected, the setting will be unavailable and system will use USB to control.

Network modes include "Manually" and "Automatically". It is obtained through DHCP while in "Automatically" mode.

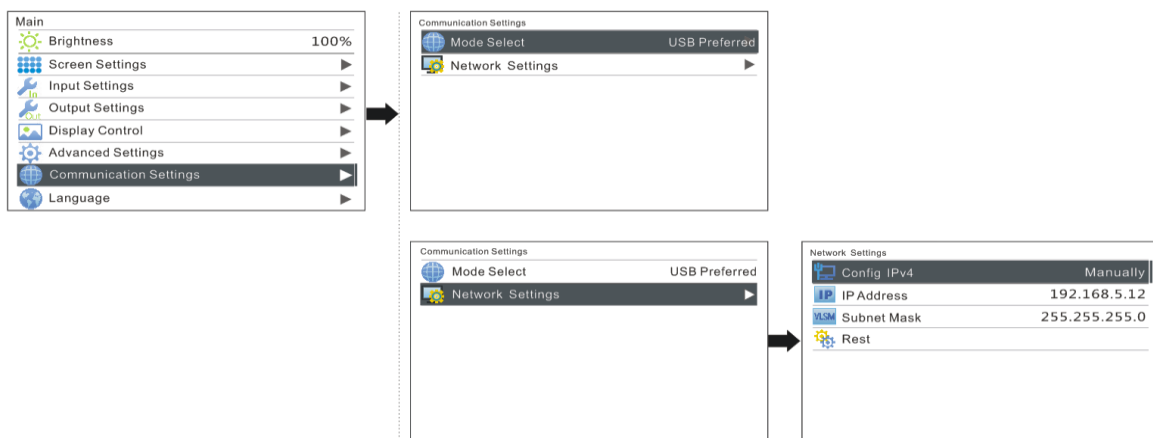

6.10 Language Settings

NovaPro HD supports Chinese and English at present.



7 Web Interface Operation

Access Web control interface of Pro HD through browser. Main operating steps, functions and corresponding parameter configuration requirements are the same as the operation of the controller. This chapter only covers network establishment, motion description and features of Web interface operations. Please refer to the relevant chapters of controller operation for specific parameter configurations and configuration requirements.

7.1 Network Establishment

- 1) Connect Pro HD to the same LAN and network segment as the control computer.
- 2) Turn on the power of Pro HD and set communication settings on the controller referring to [7.9 Communication Setting](#). Local IP can be obtained automatically or manually if you know the IP address.
- 3) Open up the browser on control computer. Enter the local IP of Pro HD and open up the web configuration interface.

7.2 Operating Motion Description

The Web interface of Pro HD is shown as the picture below. Compared with controller operation, the operation with Web interface is more intuitional and clearer.

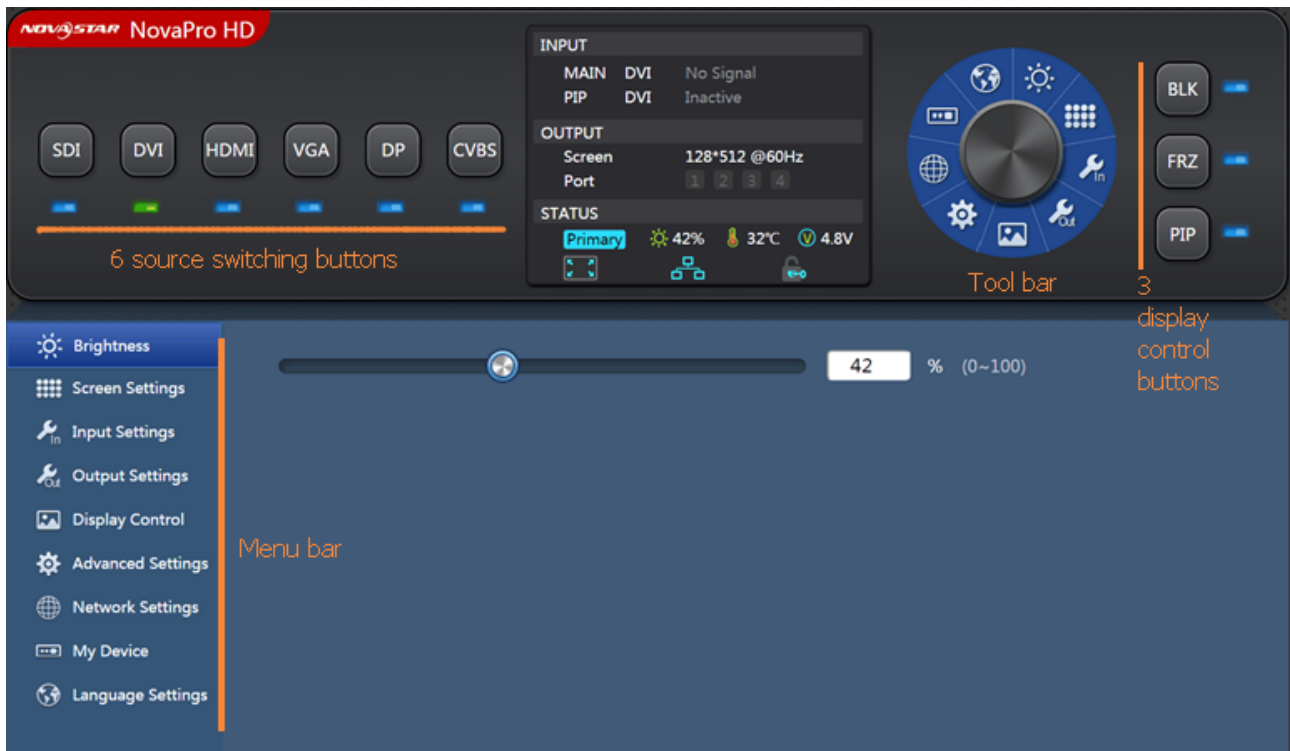

Toolbar: The toolbar will be highlighted when you move the mouse over it. By clicking the toolbar, you can get into the configuration pages of sub menus. The functions are the same as the menus in the bottom left of the page.

Menu bar: click the mouse and enter the parameter configuration interface in the main menu. If there are sub menus, sub menu bar will pop out.

Six input source switching buttons: the input source of the main screen can be switched with mouse clicking. The switching of the input source of PIP needs to enter "Advanced Settings" → "PIP" sub menu interface settings, as shown in the figure below.



Three display control buttons: the indicator lights default to blue and turn green when enabled.

7.3 My Device

The name of the device can be modified, which is a unique function of Web interface operation.

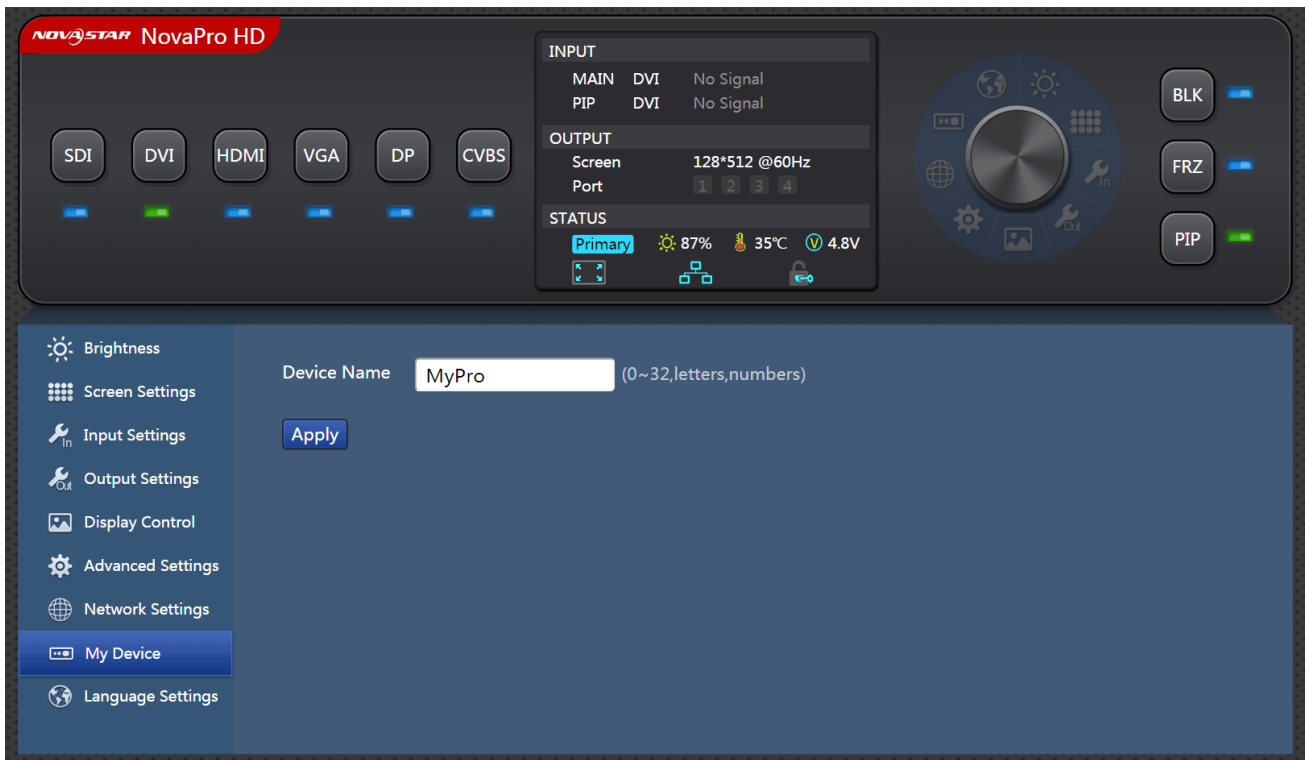

8 LCT Client Operation

Communication between control computer and Pro HD is via USB control cable. Compared with the operation through controller and Web, LCT client can provide users with the most comprehensive functions and configuration parameters.

The main functions include screen configuration, brightness adjustment, monitoring, calibration, etc. Please refer to *Nova M3 Control System User Manual* for specific operations of these functions.

Operation interface of LCT client is shown as the figure below:

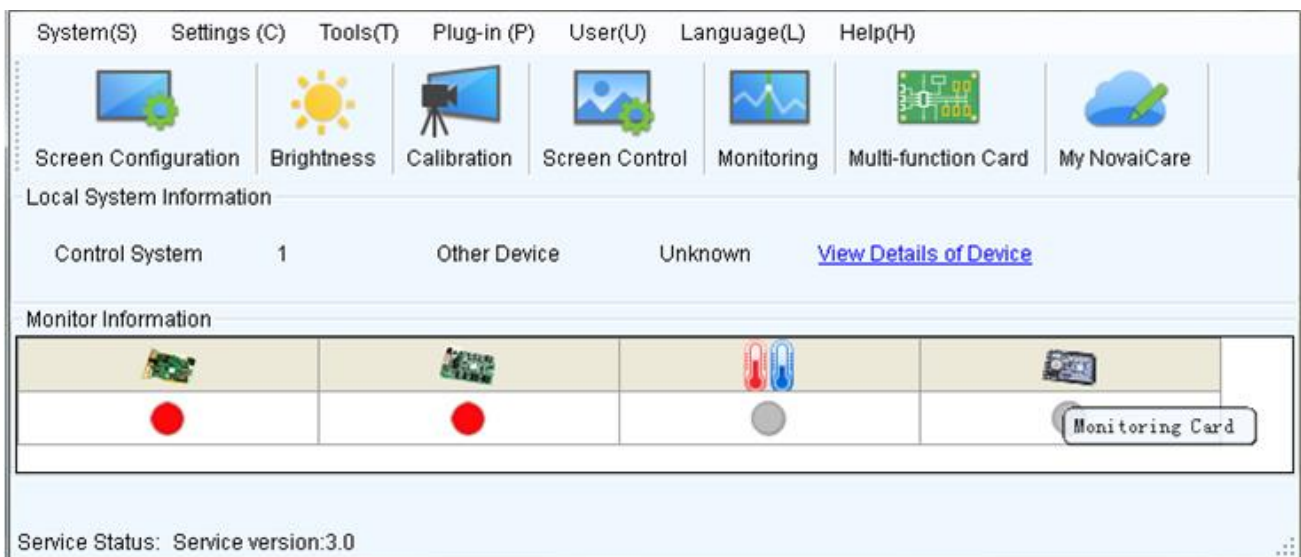

9 Firmware Upgrade

There are two ways to upgrade the firmware of Pro HD: upgrade by U disk and LCT client.

1) Upgrading firmware by U disk

Firmware upgrade by U disk must meet two conditions:

- a) The format of the U-disk must be FAT12/16/32.
- b) Software package must extract to the root directory of the U-disk.

There are two ways to upgrade firmware by U-disk: a) Plug U disk into the USB port on the front panel. Press FRZ button and PIP button simultaneously when turning on power and the unit will enter firmware upgrade mode. b) Plug in U disk after power on. Choose whether to upgrade or not according to prompt.

2) Upgrading firmware by LCT client

Connect Pro HD to PC and run NovaLCT-Mars on PC. Log in advanced user and the password is "admin". Then click "admin" on your keyboard after logging in and

the program loading page will pop up.

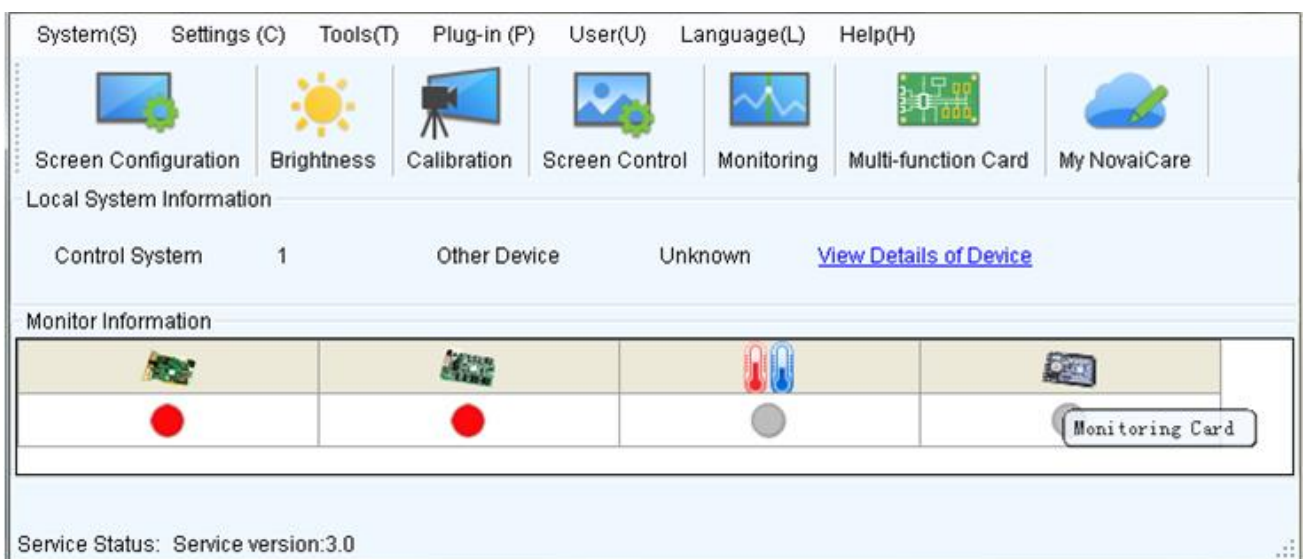
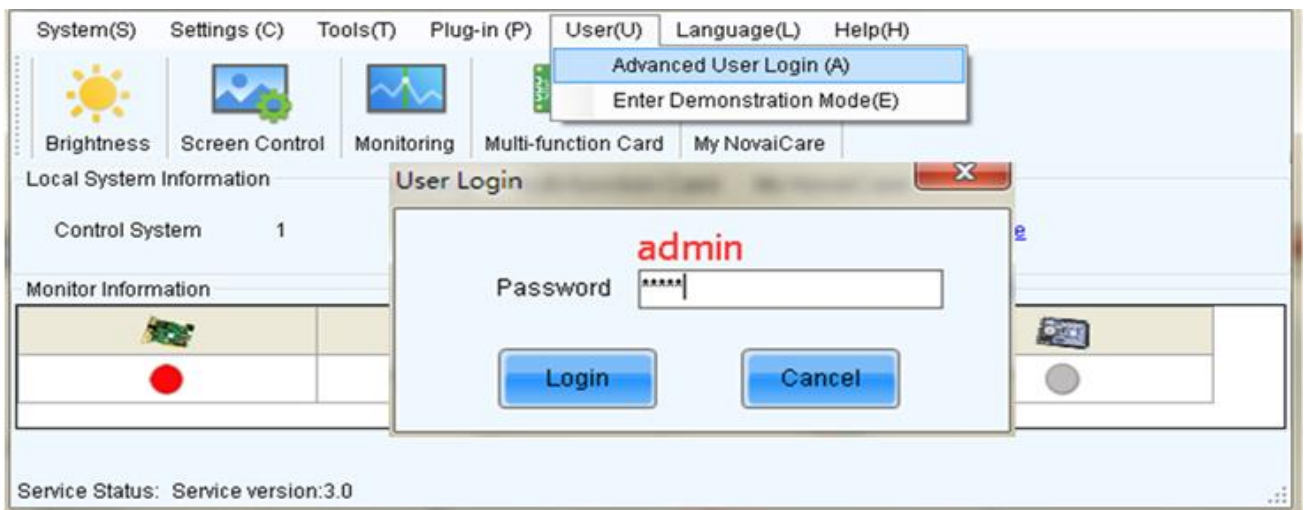
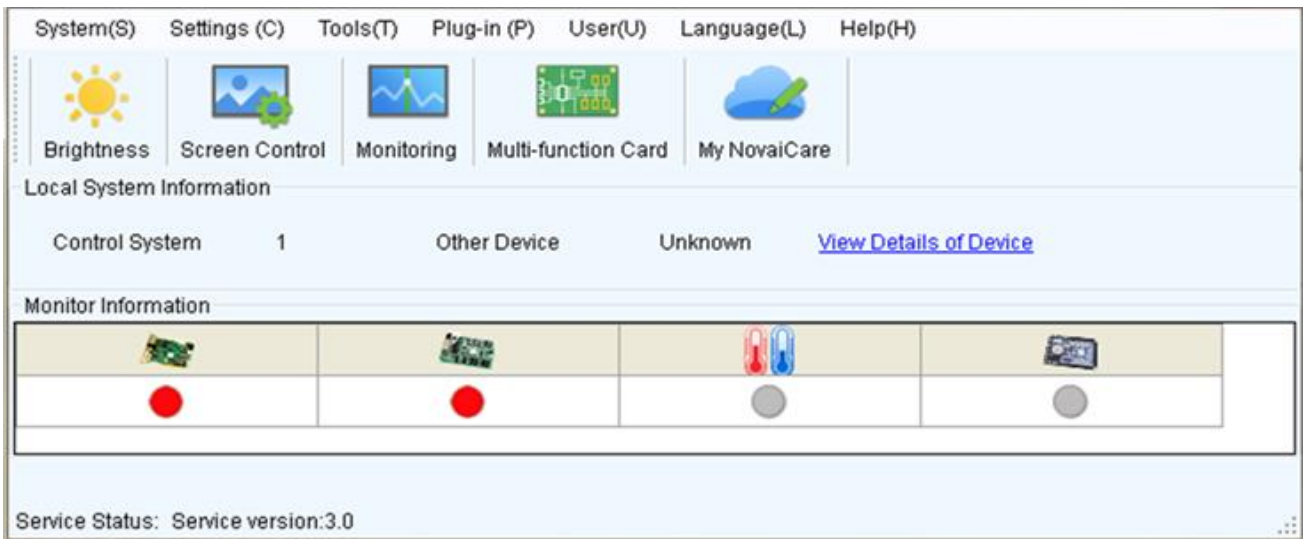

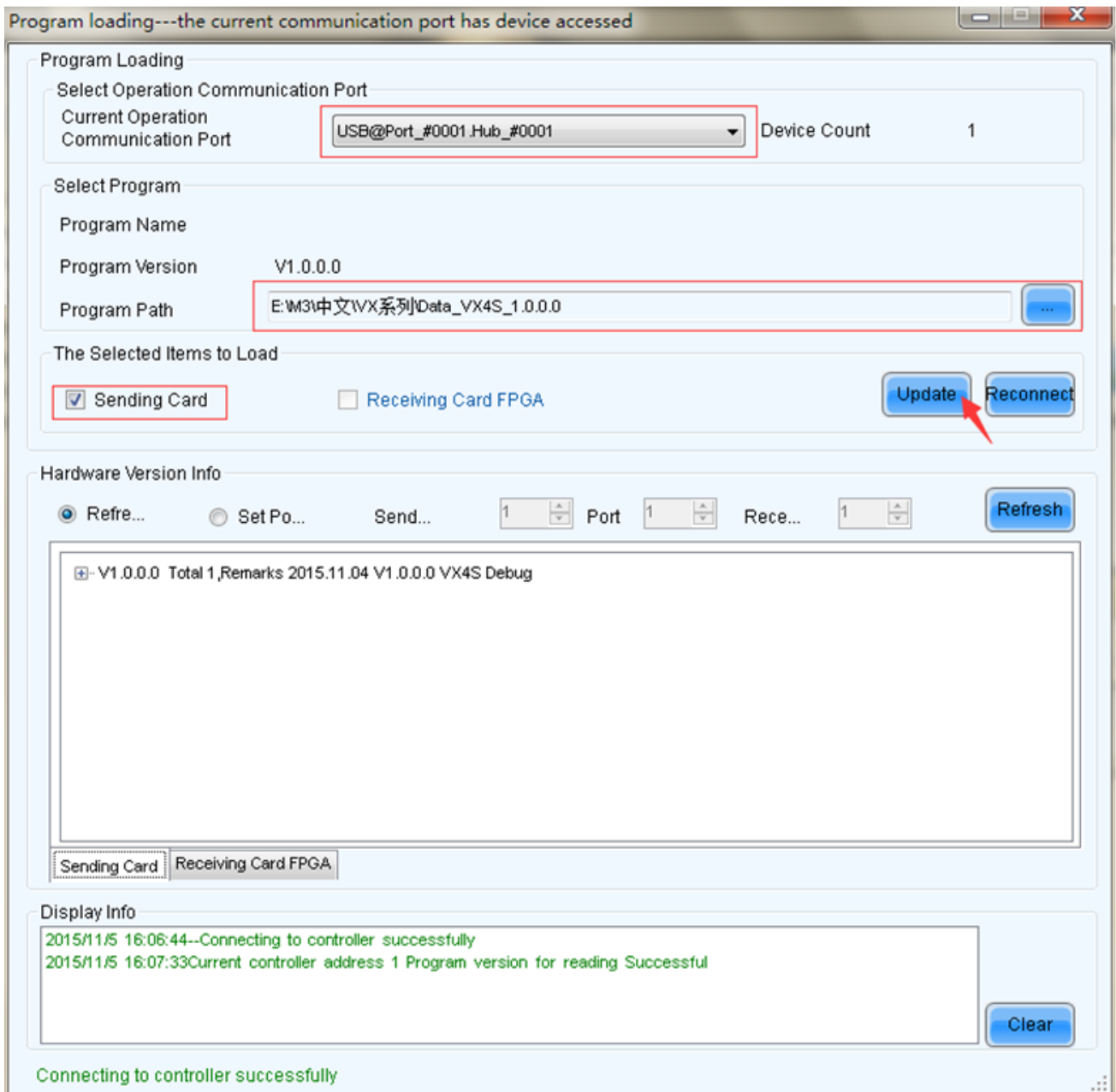

Current operation communication port: Choose the serial port, the hardware program of which is to be upgraded.

Program path: Select the hardware program to be upgrade currently.

Sending card: Check to update all the programs of sending card.

FPGA of receiving card: Check to update FPGA program of receiving card.

Update: Change hardware program into hardware device.

Refresh all: Check this option and click “Refresh” to refresh and display the program versions of all sending card and receiving card of current serial port.

Set refresh: Click “Refresh” to set refresh and display the version information of one receiving card.

Refresh: Refresh and display the version information of hardware in order to make sure the hardware program is updated.

10 Troubleshooting and Precautions

| Problem | Solution |
|------------------------------------|---|
| Blank screen of LED display | <p>Check whether the power is correctly connected and the switch is on.</p> <p>Use test pattern to check whether the LED is correctly connected and is working properly.</p> <p>Check whether Pro HD has signal input and the output is set as black out.</p> <p>Check whether the display configuration mode and parameters are correct.</p> |
| Monitoring port output is abnormal | <p>Check whether the input channel has image input and it is displayed normally.</p> <p>Check whether PIP is enabled and channel 2 has signal input and the image is displayed normally.</p> <p>Check whether monitor output is connected correctly and the connection is not loose.</p> |

| | |
|----------------------------|---|
| | <p>If connecting Pro to display, please confirm whether the display supports the output resolution of Pro.</p> <p>Try to cut the power and restart the device. Then reset Pro and do the operations again.</p> |
| VGA input phase offset | Perform VGA auto fit |
| PIP displays abnormally | <p>Check whether channel 2 has signal input and it is displayed normally.</p> <p>Check whether the parameter settings of PIP are correct.</p> |
| Channel effect is abnormal | Check whether channel is switched on. |
| Montage is abnormal | <p>Check whether montage is enabled and the parameter settings are correct.</p> <p>Check whether input signal is normal.</p> |
| Precautions | <p>1) This product only supports rectangular screen composed of cabinets with same size and specifications for machine configuration. Irregular cabinets and screens need to be configured on LCT client.</p> <p>2) It is not recommended to alternately operate one LED display via machine operation, Web operation and LCT client operation.</p> |

Please troubleshoot the devices according to above steps. If problems cannot be solved, please contact our local dealers or customer service department. Since there

are components with high voltage inside the controller, please DO NOT maintain it by yourself for the sake of your safety.

11 Technical Specifications

| Inputs | | |
|---------------|-----|---|
| Port | Qty | Description |
| CVBS | 1 | PAL/NTSC |
| VGA | 1 | VESA standard |
| DVI | 1 | VESA standard (supporting 1080i input), supporting HDCP |
| HDMI | 1 | EIA/CEA-861 standard, in accordance with HDMI-1.3 standard, supporting HDCP |
| DP | 1 | VESA standard |
| 3G-SDI | 1 | 480i, 576i, 720p, 1080i/p (3G SDI) |

| Outputs | | |
|----------------|-----|--|
| Port | Qty | Description |
| DVI LOOP | 1 | DVI loop output, consistent with DVI input connector |
| SDI LOOP | 1 | SDI loop output, consistent with SDI input connector |

| | | |
|------------|---|---|
| LED Output | 4 | 4 Gigabit Ethernet outputs. Only Ethernet port 1 supports audio output. When the multifunction card is connected for audio decoding, the multifunction card must be connected to the Ethernet port 1. Maximum horizontal resolution is 3840 pixels. Maximum vertical resolution is 1920 pixels. |
| OPT Output | 4 | 4 optical fiber connectors for long-distance transmission |
| Monitor | 2 | DVI and HDMI connectors for output image monitoring DVI and HDMI connectors output the same image. |

Control Interface

| Port | Qty | Description |
|------|-----|--|
| USB | 2 | Upper computer control interface |
| RJ45 | 1 | Multi-units communication interface |
| DMX | 1 | Connected to all kinds of control interfaces that support DMX512 interface protocol. |

Overall Specifications

| | |
|---------------------------|----------------------|
| Input power | AC 100-250V, 50/60Hz |
| Overall power consumption | 30 W |

| | |
|------------------------|---------------------------|
| Operating temperature | -20~60°C |
| Dimensions (L x W x H) | 483 mm x 389 mm x 88.2 mm |
| Weight | 6 kg |

12 Installation Dimensions

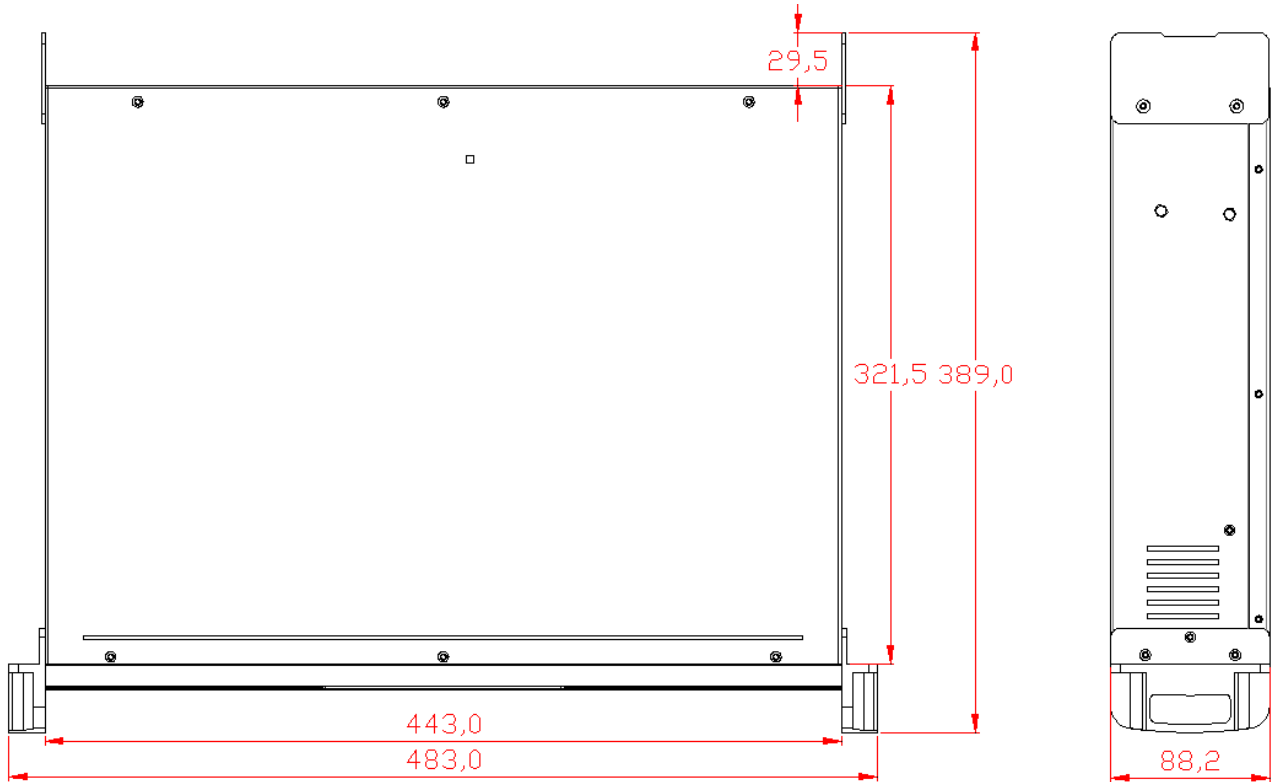

(Unit: mm)