

# SX210

## Slimline Dual-driver Subwoofer

### Features

- Slimline direct-radiator subwoofer
- 2 x 10" (250mm) drivers with 2" (50mm) voice coils
- Large ports for reduced air noise
- Perforated steel grille
- 4Ω nominal impedance
- M10 flying inserts

### Applications

- Portable sound reinforcement
- Live music clubs
- Bars and restaurants
- Nightclubs
- Corporate AV events and conferences
- Weddings and parties
- Secondary stages at festivals
- HoW, leisure centres and retail outlets



The SX210 is a slimline dual-driver subwoofer designed for situations that call for a visually unobtrusive enclosure. It can be used singly, stacked or flown via integral M8 inserts and its ultra-compact size makes it ideal for applications where space is limited. It features dual 10" (250mm)/2" (50mm) voice coil drivers and generously sized low frequency ports for reduced air noise.

The SX210 enclosure is constructed from plywood and finished in black textured paint as standard, with white and RAL colour finish-es available to special order. An impact-resistant perforated steel grille protects the drivers, and the enclosure has twin ergonomic handles at the rear for easy handling. Rubber feet on the base resist movement and align with recesses in the top surface to assist stacking.

When used with full-range systems, crossover and EQ functions can be performed by the DX0.5 or DX4.0 system controller. The recommended amplifier is the VIA 2502, or VIA 5002 or VIA 5004 depending upon the size of the overall system.

# SX210

## Slimline Dual-driver Subwoofer

### Technical Specifications

TYPE	Slimline, direct radiating subwoofer
FREQUENCY RESPONSE (1)	50Hz-150Hz $\pm$ 3dB -10dB @ 42Hz
DRIVER	2 x 10" (250mm)/2" (50mm) voice coil, long excursion, ferrite magnet
RATED POWER (2)	500W AES, 2000W peak
RECOMMENDED AMPLIFIER	VIA2502/5002/5004
SENSITIVITY (10)	103dB
MAXIMUM SPL (9)	127dB continuous, 133dB peak (half space)
NOMINAL IMPEDANCE	4 ohms
DISPERSION (-6dB)	Omnidirectional
CROSSOVER	80-120Hz active
ENCLOSURE	Birch/poplar ply
FINISH	Black textured paint
PROTECTIVE GRILLE	Black perforated steel
CONNECTORS	2 x NL4 type
PIN CONNECTIONS (INPUT)	1+/-
PIN CONNECTIONS (LINK)	1+/- to 1+/-
FITTINGS	16 x M8 inserts, 2 x bar handles
DIMENSIONS (INCL FEET)	(W) 718mm x (H) 295mm x (D) 465mm (W) 28.3ins x (H) 11.4ins x (D) 18.3ins
WEIGHT	20kg (44.1lbs)

#### Notes

- (1) Measured on-axis in half (2pi) space at 2 metres, then referred to 1 metre.
- (2) AES Standard ANSI S4.26-1984.
- (3) Measured in half (2pi) space at 2 metres with 1 watt input, using band limited pink noise, then referred to 1 metre.
- (4) Measured in half (2pi) space at 2 metres using band limited pink noise, then referred to 1 metre.
- (5) Measured on-axis in open (4pi) space at 2 metres, then referred to 1 metre.
- (6) Measured in open (4pi) space at 2 metres with 1 watt input, using band limited pink noise, then referred to 1 metre.
- (7) Measured in open (4pi) space at 2 metres using band limited pink noise, then referred to 1 metre.
- (8) Measured in open (4pi) space at 2 metres with 2.83V input, using band limited pink noise, then referred to 1 metre.
- (9) Calculated at 1 metre.
- (10) Measured in half (2pi) space at 2 metres with 2.83V input, using band limited pink noise, then referred to 1 metre.

#### Trade Descriptions Act

Due to Martin Audio's policy of continuing improvement, we reserve the right to alter these specifications without prior notice. Martin Audio is committed to refining state of the art sound reinforcement, combining in-depth product and field applications research with advanced manufacturing techniques. Every Martin Audio product is built to the highest manufacturing standards and rigorously tested to ensure that it meets the performance criteria specified in the design.

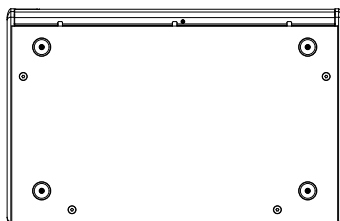
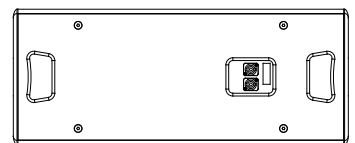
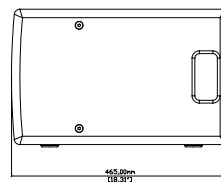
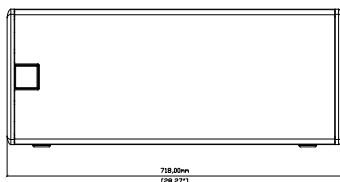
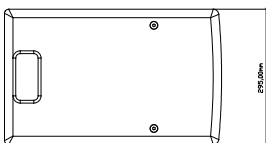
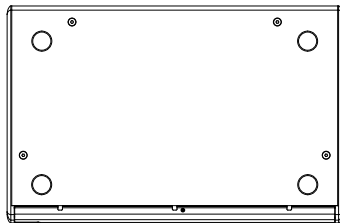
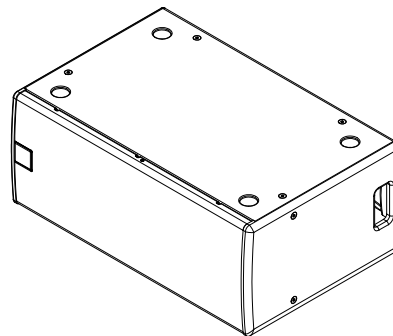

SX210

Martin Audio Ltd  
Century Point, Halifax Road, High Wycombe  
Buckinghamshire HP12 3SL, England

Telephone: +44 (0) 1494 535 312  
Facsimile: +44 (0) 1494 438 669  
Email: [info@martin-audio.com](mailto:info@martin-audio.com)

All information is Copyright © 2018 Martin Audio Ltd.



[www.martin-audio.com](http://www.martin-audio.com)