

VLZ4 4•Bus

24-/32-Channel 4-Bus FX Mixer with USB

OWNER'S MANUAL

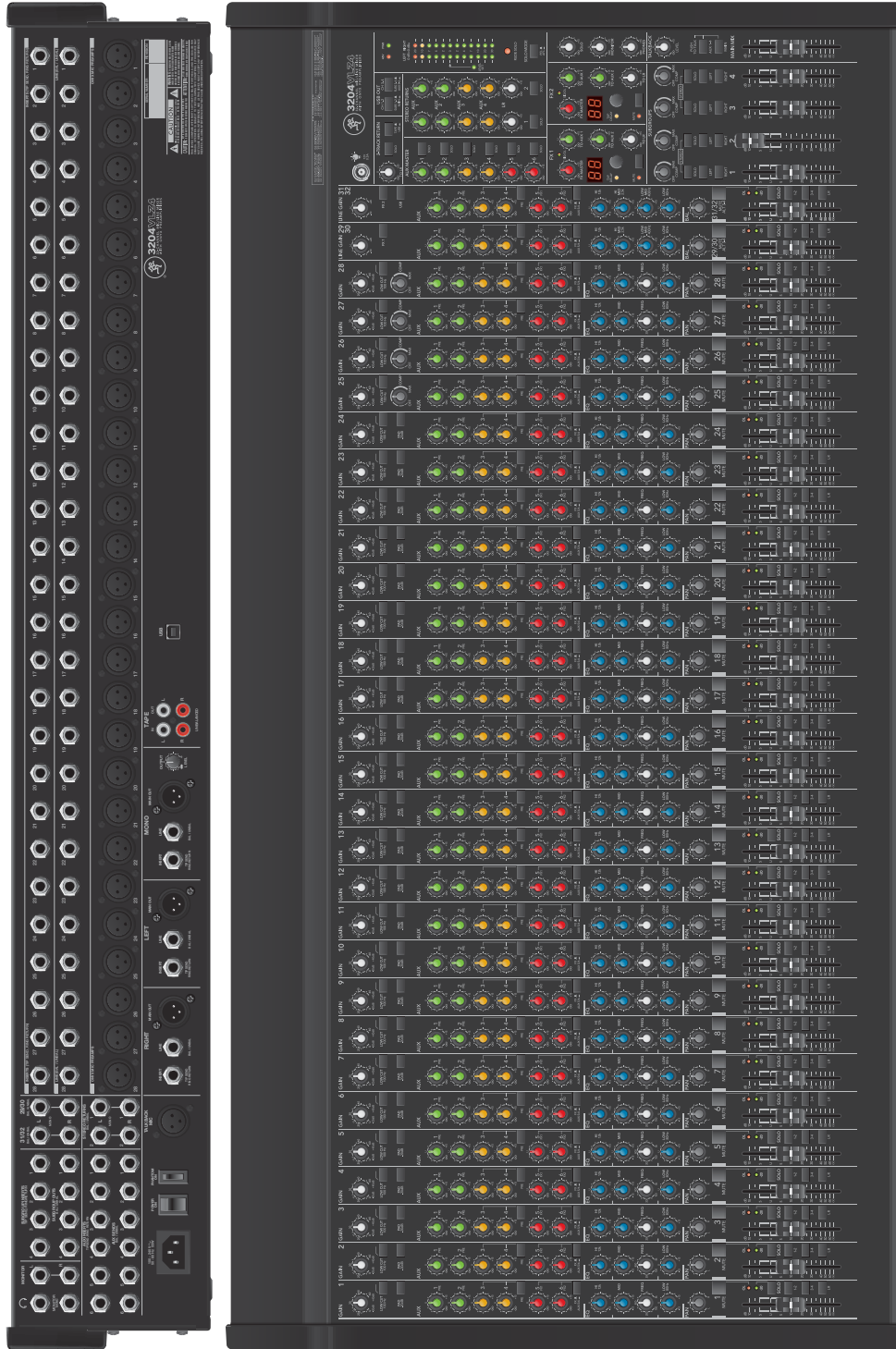

Important Safety Instructions

1. Read these instructions.
2. Keep these instructions.
3. Heed all warnings.
4. Follow all instructions.
5. Do not use this apparatus near water.
6. Clean only with a dry cloth.
7. Do not block any ventilation openings. Install in accordance with the manufacturer's instructions.
8. Do not install near any heat sources such as radiators, heat registers, stoves, or other apparatus (including amplifiers) that produce heat.
9. Do not defeat the safety purpose of the polarized or grounding-type plug. A polarized plug has two blades with one wider than the other. A grounding-type plug has two blades and a third grounding prong. The wide blade or the third prong are provided for your safety. If the provided plug does not fit into your outlet, consult an electrician for replacement of the obsolete outlet.
10. Protect the power cord from being walked on or pinched particularly at plugs, convenience receptacles, and the point where they exit from the apparatus.
11. Only use attachments/accessories specified by the manufacturer.
12. Use only with a cart, stand, tripod, bracket, or table specified by the manufacturer, or sold with the apparatus. When a cart is used, use caution when moving the cart/apparatus combination to avoid injury from tip-over.
13. Unplug this apparatus during lightning storms or when unused for long periods of time.
14. Refer all servicing to qualified service personnel. Servicing is required when the apparatus has been damaged in any way, such as power-supply cord or plug is damaged, liquid has been spilled or objects have fallen into the apparatus, the apparatus has been exposed to rain or moisture, does not operate normally, or has been dropped.
15. This apparatus shall not be exposed to dripping or splashing, and no object filled with liquids, such as vases or beer glasses, shall be placed on the apparatus.
16. Do not overload wall outlets and extension cords as this can result in a risk of fire or electric shock.
17. This apparatus has been designed with Class-I construction and must be connected to a mains socket outlet with a protective earthing connection (the third grounding prong).
18. This apparatus has been equipped with a rocker-style AC mains power switch. This switch is located on the rear panel and should remain readily accessible to the user.
19. The MAINS plug or an appliance coupler is used as the disconnect device, so the disconnect device shall remain readily operable.



20. NOTE: This equipment has been tested and found to comply with the limits for a Class B digital device, pursuant to part 15 of the FCC Rules. These limits are designed to provide reasonable protection against harmful interference in a residential installation. This equipment generates, uses, and can radiate radio frequency energy and, if not installed and used in accordance with the instructions, may cause harmful interference to radio communications. However, there is no guarantee that interference will not occur in a particular installation. If this equipment does cause harmful interference to radio or television reception, which can be determined by turning the equipment off and on, the user is encouraged to try to correct the interference by one or more of the following measures:
 - Reorient or relocate the receiving antenna.
 - Increase the separation between the equipment and the receiver.
 - Connect the equipment into an outlet on a circuit different from that to which the receiver is connected.
 - Consult the dealer or an experienced radio/TV technician for help.

CAUTION: Changes or modifications to this device not expressly approved by LOUD Technologies Inc. could void the user's authority to operate the equipment under FCC rules.

21. This apparatus does not exceed the Class A/Class B (whichever is applicable) limits for radio noise emissions from digital apparatus as set out in the radio interference regulations of the Canadian Department of Communications.

ATTENTION — *Le présent appareil numérique n'émet pas de bruits radioélectriques dépassant les limites applicables aux appareils numériques de class A/de class B (selon le cas) prescrites dans le règlement sur le brouillage radioélectrique édicté par les ministere des communications du Canada.*

22. Exposure to extremely high noise levels may cause permanent hearing loss. Individuals vary considerably in susceptibility to noise-induced hearing loss, but nearly everyone will lose some hearing if exposed to sufficiently intense noise for a period of time. The U.S. Government's Occupational Safety and Health Administration (OSHA) has specified the permissible noise level exposures shown in the following chart. According to OSHA, any exposure in excess of these permissible limits could result in some hearing loss. To ensure against potentially dangerous exposure to high sound pressure levels, it is recommended that all persons exposed to equipment capable of producing high sound pressure levels use hearing protectors while the equipment is in operation. Ear plugs or protectors in the ear canals or over the ears must be worn when operating the equipment in order to prevent permanent hearing loss if exposure is in excess of the limits set forth here:

	CAUTION AVIS	
RISK OF ELECTRIC SHOCK. DO NOT OPEN RISQUE DE CHOC ELECTRIQUE. NE PAS OUVRIR		
CAUTION: TO REDUCE THE RISK OF ELECTRIC SHOCK DO NOT REMOVE COVER (OR BACK) NO USER-SERVICEABLE PARTS INSIDE. REFER SERVICING TO QUALIFIED PERSONNEL ATTENTION: POUR EVITER LES RISQUES DE CHOC ELECTRIQUE, NE PAS ENLEVER LE COUVERCLE. AUCUN ENTRETIEN DE PIECES INTERIEURES PAR L'USAGER. CONFIER L'ENTRETIEN AU PERSONNEL QUALIFIE. AVIS: POUR EVITER LES RISQUES D'INCENDIE OU D'ELECTROCUTION, N'EXPOSEZ PAS CET ARTICLE A LA PLUIE OU A L'HUMIDITE		



The lightning flash with arrowhead symbol within an equilateral triangle is intended to alert the user to the presence of uninsulated "dangerous voltage" within the product's enclosure, that may be of sufficient magnitude to constitute a risk of electric shock to persons.
Le symbole éclair avec point de flèche à l'intérieur d'un triangle équilatéral est utilisé pour alerter l'utilisateur de la présence à l'intérieur du coffret de "voltage dangereux" non isolé d'ampleur suffisante pour constituer un risque d'électrocution.



The exclamation point within an equilateral triangle is intended to alert the user of the presence of important operating and maintenance (servicing) instructions in the literature accompanying the appliance.
Le point d'exclamation à l'intérieur d'un triangle équilatéral est employé pour alerter les utilisateurs de la présence d'instructions importantes pour le fonctionnement et l'entretien (service) dans le livret d'instruction accompagnant l'appareil.

Duration, per day in hours	Sound Level dBA, Slow Response	Typical Example
8	90	Duo in small club
6	92	
4	95	Subway Train
3	97	
2	100	Very loud classical music
1.5	102	
1	105	Matt screaming at Troy about deadlines
0.5	110	
0.25 or less	115	Loudest parts at a rock concert

WARNING — To reduce the risk of fire or electric shock, do not expose this apparatus to rain or moisture.



Correct disposal of this product. This symbol indicates that this product should not be disposed of with your household waste, according to the WEEE Directive (2002/96/EC) and your national law. This product should be handed over to an authorized collection site for recycling waste electrical and electronic equipment (WEEE). Improper handling of this type of waste could have a possible negative impact on the environment and human health due to potentially hazardous substances that are generally associated with WEEE. At the same time, your cooperation in the correct disposal of this product will contribute to the effective usage of natural resources. For more information about where you can drop off your waste equipment for recycling, please contact your local city office, waste authority, or your household waste disposal service.

Contents

Important Safety Instructions	2	41. Solo.....	20
Contents.....	3	42. Assign	20
Features	4	43. Channel Fader	20
Introduction	5	44. FX1 And FX2.....	20
Getting Started.....	6	45. USB Switch	20
Hookup Diagrams.....	7	2-Track, USB, Aux Masters And Meters.....	21
VLZ4 4•Bus Features	9	46. Lamp	21
Rear Panel - Connections	9	47. Suck Knob.....	21
1. Mic Ins	9	48. 2-Track Return Level.....	21
2. Line Ins.....	9	49. 2-Track Return Solo.....	21
3. Insert	10	50. 2-Track Return Tape/USB	21
4. Stereo Line Ins	10	51. USB Out.....	22
5. Stereo Returns 1-2.....	10	52. Master Aux Sends 1-6.....	22
6. Tape Ins / Outs.....	10	53. Master Aux Sends Solo.....	22
7. L/R Main Outs: XLR & 1/4".....	11	54. Stereo Returns 1-2 To Aux 1-4/Main.....	22
8. Main Inserts	11	55. Stereo Returns Solo.....	22
9. Mono Out	11	56. 48V Led.....	22
10. Mono Out Level Control	11	57. Power Led	22
11. Group Outs 1-4.....	11	58. Left/Right Level Meters	23
12. Group Inserts	11	59. Rude Solo Light	23
13. Aux Sends 1-6	11	60. Solo Mode	23
14. Aux Inserts	12	Stereo Effects Processors, Headphones, Talkback, ...	
15. Left/Right Monitor Outs	12	Main And Groups Mix	24
16. Mono Monitor Out.....	12	61. FX1 And FX2 Send Master	24
17. Headphone Out	12	62. FX1 And FX2 To Aux 1/Aux 2/Main.....	24
18. USB In/Out.....	12	63. Sig/OL LED.....	24
19. Talkback Mic	14	64. Preset Display.....	24
20. Power	14	65. Preset Selector, Tap Delay And LED.....	25
21. 48V Phantom Power	14	66. Internal FX Mute	25
22. Power Connection.....	14	67. Solo Level	25
Front Panel - Knob Twiddlin' Section.....	15	68. Monitor Level.....	26
23. Gain Control.....	16	69. Phones Level.....	26
24. Low Cut	16	70. Talkback Level.....	26
25. Pad (-20 dB) Switch	16	71. Push To Talk: Main, Aux 1-4	26
26. Compressor	17	72. Compressor.....	26
27. Aux Sends 1-6	18	73. Groups Assign.....	26
28. Pre-Fader / Aux Sends 1-2.....	18	74. Group 1-4 Faders	27
29. Int Fx 1-2 / Aux Sends 5-6	18	75. Main Mix.....	27
30. Int Fx / Aux 5-6 Switch	18	Appendix A: Service Information	28
31. High EQ	19	Appendix B: Connections.....	28
32. Mid EQ	19	Appendix C: Technical Information	31
33. Mid EQ Frequency.....	19	Appendix D: USB.....	37
34. Low EQ.....	19	Appendix E: Table of Effects Presets	38
35. High Mid EQ Level	19	Limited Warranty.....	39
36. Low Mid EQ Level.....	19		
37. Pan	19		
38. Mute	19		
39. OL LED.....	19		
40. Sig LED	20		

Part No. SW0974 Rev. B 06/13

©2013 LOUD Technologies Inc. All Rights Reserved.

Based off of the highly recommended book, *246 Ways to Clean a Cat Box*.



Like us



Follow us



Watch our dang videos

Owner's Manual

Features

- 4•bus mixer featuring our signature high-headroom, low-noise design
- Boutique-quality Onyx mic preamps
 - Ultra-wide 60 dB gain range
 - 128.5 dB dynamic range
 - +22 dBu line input handling
 - Extended frequency response
 - Distortion under 0.0007% (20 Hz - 50 kHz)
- Improved RF rejection, perfect for broadcast applications
- Phantom power for condenser mics
- Dedicated inline channel compression for critical inputs
- High-headroom line inputs with dedicated inserts
- 3-band EQ with sweepable midrange
- 18 dB/oct 100 Hz low-cut filter on mic input channels
- Level, pan, solo and overload/mute LEDs on each channel
- Four subgroups featuring dedicated inline compressors for total dynamic control
- Six aux sends with inserts, pre/post fader and internal/external FX send options
- Two stereo returns and four group outs with inserts
- Dual 32-bit RMFX+™ processors featuring 24 “Gig Ready” reverbs, choruses and tap delay for live applications
- Integrated 4x2 24-bit USB interface
 - Stream subgroups or master L/R to your PC or Mac for recording
 - Use your favorite plug-in live via auxes 5/6
 - Convenient stereo return to mains for music playback or return to channel to implement EQ, auxes and more
- PFL/AFL solo modes
- 60mm long-wearing log-taper faders
- High-resolution 12-segment stereo meters
- Sealed rotary control resist dust and grime
- “Built-Like-A-Tank” rugged steel chassis with powder-coat finish
- High-visibility, high-contrast controls deliver convenient “at-a-glance” visual feedback
- Universal power supply for worldwide use

How To Use This Manual

After the introduction, a getting started guide will help you get things set up fast. These are followed by hookup diagrams which show some typical setups.

Next is a detailed tour of the entire mixer. The descriptions are divided into sections, just as your mixer is organized into distinct zones:

- Rear Panel / Connections
- Channel Controls
- 2-Track, USB, Aux Masters, Meters
- Stereo Effects Processors, Headphones, Talkback, Main and Groups Mix

Throughout these sections you’ll find illustrations with each feature numbered and described in nearby paragraphs.



This icon marks information that is critically important or unique to the mixer. For your own good, read them and remember them.



This icon will lead you to some explanations of features and practical tips. They usually have some valuable nuggets of information.

Introduction

Awesomely unheard of features

USB Recording and Playback

The VLZ4 4•Bus Series Mixers feature a 4x2 USB recording and playback function. This means up to four signals may be recorded simultaneously and a stereo mix returned to the mixer for playback.

There are two switches in the master section labeled “USB OUT” that allow for monstrous flexibility on the four recordable signals. The default switch configuration routes subgroups 1-4 over the USB connection to your favorite DAW software for a “mix it later” 4-track recording. The Subgroup 1-2 switch also allows the L-R mix to be recorded for convenient stereo mixes of the show. The Subgroup 3-4 switch allows aux 5/6 to be sent to the DAW for a unique stereo recording or the use of DAW plug-ins as effects.

For playback, there are two switches in the master section labeled “2-TRACK RETURN”. One switch [TAPE/USB] changes the standard dual RCA inputs to main (tape, switch disengaged) to stereo USB to main (USB, switch engaged). This is an extremely convenient function for playing music over the main mix from a computer.

Another cool feature of the VLZ4 4•Bus is routing the stereo USB return to the last stereo channel of the mixer. This is a mighty fine tool for a number of live and recording uses. For example, playback through the stereo channel allows the “Greg M designed” 4-band EQ to be utilized to sweeten the sounds. It may also be used for overdubbing by sending music to the musicians' headphones through the auxes.

Last, but not least, it may be used to return plug-in effects from the DAW in a live mix scenario. One of our favorites is the CamelPhat VST that makes your average drummer sound like Bonham on *How The West Was Won*.

Powerful on-board dual FX engines and eight individual compressors

In pursuit of the ultimate “do-it-all” Live Sound Mixer, we threw in the kitchen sink and packed this bad boy with a full set of processors allowing you to travel “rack free” while still making professional sounding mixes.

For starters, we added not one, but TWO, of our patented Running Man FX processors (RMFX+™) featuring 24 “gig-ready” effects right into the board. This does not include useless effects such as “the warbler” or the “insanity delay”, but rather a suite of quickly accessible and useable reverbs, choruses and delays that make coloring your mix a breeze.

Additionally, both FX processors feature a tap delay, typically only available on an outboard rack. Delays may easily be sync'd with the song at the tap of a finger. And because we love flexible routing (hehe), the processed signal may be sent direct to the mains and monitors from the effects section or re-routed to the two stereo channels to bring them through the EQ and aux section, utilizing the 60mm fader to draw them into the mix.

But wait, there's more! The VLZ4 4•Bus has eight (yes, eight!) single knob compressors to stop the dynamic signals from poking out of the mix. Four compressors are located on the last four mic inputs so that the most critical signals (such as vocals, snare drum, the occasional jaw harp or mountain goats) may be addressed. Plus, there are single knob compressors on each of the four subgroups so that grouped signals (such as a drum set or a choir of didgeridoos) may be blended together for paramount smoothness.

Bottom line? You have an awesome mixer with VLZ4 sound quality, “built-like-a-tank” build quality and a recording and processing feature set that is unparalleled. Congratulations... and happy mixing!

Need help with your mixer?

- Visit www.720trees.com and click Support to find: FAQs, manuals and other useful information.
- Email us at: techmail@loudtechinc.com.
- Telephone 1-800-898-3211 to speak with one of our splendid technical support chaps (Monday through Friday, normal business hours, Pacific Time).

Getting Started

We realize that you must be really keen to try out the mixer. Please read the safety instructions on page 2, then have a look through some of the features and details in this manual.

Setup

Use the mixer in a nice clean and dry environment, free from dryer lint and dust bunnies.

Zero the controls

1. Fully turn down all the knobs to minimum, except for the channel EQ and pan controls, which should be centered.
2. Make sure all buttons are in the out position.

Connections

1. Make sure the AC power switch is off before making any connections.
2. Push the linecord securely into the IEC connector on the rear panel, and plug it into a 3-prong AC outlet. The mixer can accept any AC voltage ranging from 100 VAC to 240 VAC.
3. Plug a balanced microphone into one of the mic XLR (3-pin) connectors. Or connect any line-level signal (keyboard, or guitar preamp) to a line input jack using a TS or a TRS 1/4" plug.
4. If your microphone requires phantom power, turn on the 48V phantom power button.
5. All mono channels have insert jacks that can be used to connect an external effects or dynamics processor into the signal chain.
6. Connect the main outputs of the mixer (either XLR or TRS 1/4") to the line level inputs of your amplifier (with speakers already attached) or to the line level inputs of powered speakers.

Set the levels

It's not even necessary to hear what you're doing to set optimal levels. But if you'd like to: Plug headphones into the phones output jack, then turn up the phones knob just a little.

1. Turn on the mixer by pressing the top edge of the power switch.
2. For one channel, press the solo switch in, and the rude solo light will turn on.
3. Play something into that input at real-world levels.
4. Adjust that channel's gain control until the right main meter stays around the 0 dB LED (marked "level set").
5. Disengage the channel's solo switch.
6. Repeat steps 2 to 5 for the remaining channels.
7. Turn up the channel fader to the "U" mark.
8. Slowly turn up the main mix fader until you hear the signals in your headphones.
9. If needed, apply some channel EQ wisely.
10. Adjust the channel levels to get the best mix. Keep the gain controls and levels fully down on unused channels.
11. During the performance, if you notice a channel OL LED turning on during peaks, carefully turn down that channel's gain control until OL does not turn on.

Things to Remember

- Never listen to loud music for prolonged periods. Please see the Safety Instructions on page 2 for information on hearing protection.
- Always turn down the phones level when making connections, pressing solo, or doing anything that may cause loudness in the headphones. This will help protect your hearing.
- Always turn down the main mix level and monitor level when making connections to the mixer. Better yet, turn off the power.
- When shutting down, turn off any power amplifiers or powered speakers first. When powering up, turn them on last. This will reduce the chance of turn-on or turn-off thumps.
- Save the shipping box!

Hookup Diagrams

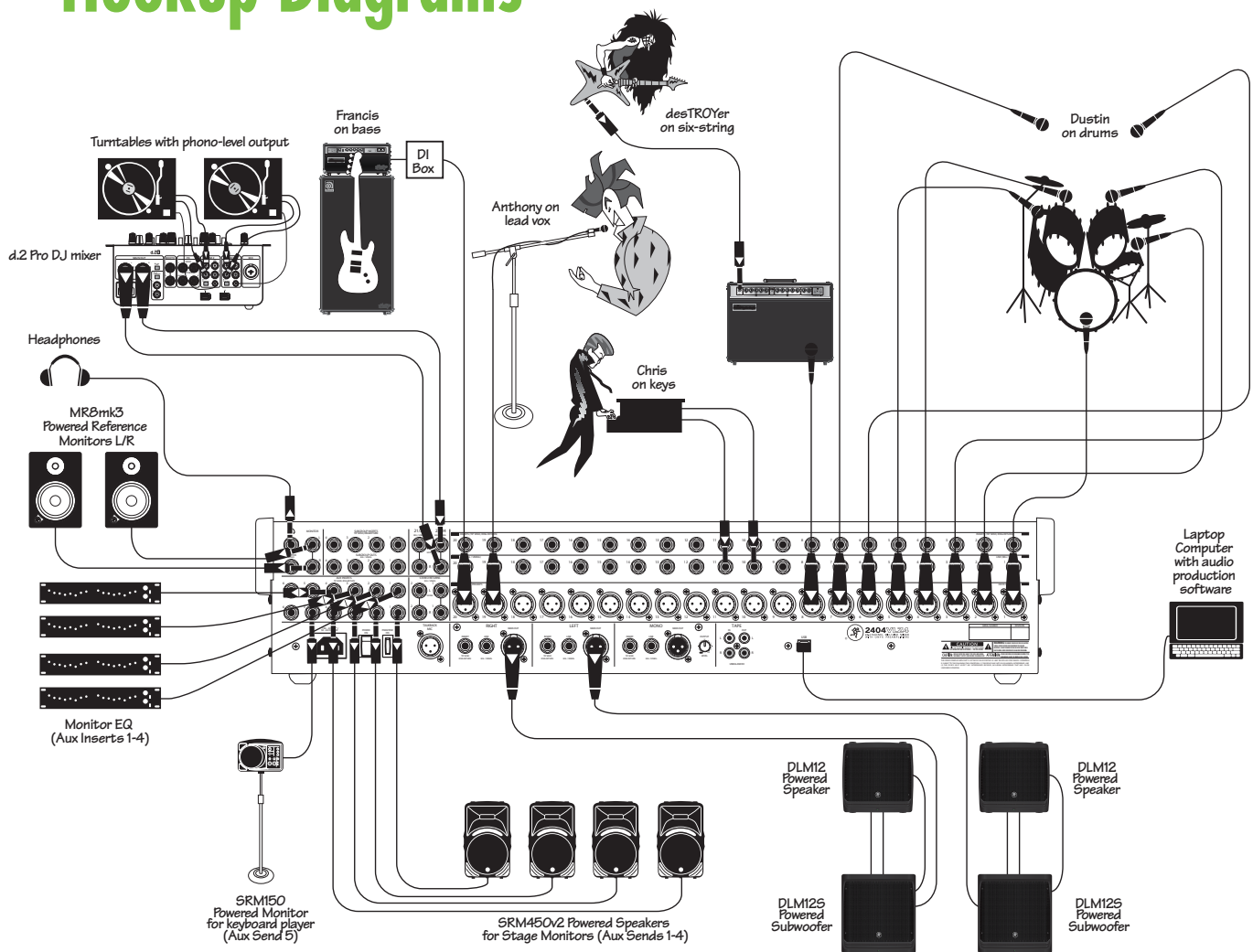

The drummer is the mic and channel hog of the band; Dustin has the kick, snare and three toms mic'd up, in addition to two overhead mics. These run to mic inputs 1-7. desTROYer is rockin' the electric guitar through an Ampeg GVT52-212 guitar amp. The amp is mic'd and connected to the channel 8 mic input. Keyboard player Chris is connected to the channel 10 and 11 line inputs...well, Chris isn't connected to the inputs; his keyboard is! Vocalist Anthony is singing through a mic connected to the mic 19 input. A bass guitar is connected to an Ampeg rig which is connected (via DI) to the mic 20 input. The last four mono channels of each 24 and 32-channel VLZ4 4•Bus mixer have built-in compressors, so feel free to "squeeze" the vocals and bass to heart's desire since they lie here. Last, but not least, a DJ is spinning records connected (via a d.2 Pro DJ mixer) to the line inputs on stereo channels 21/22. The sound guy (or gal) may monitor levels using headphones (via the headphones output) and/or a pair of MR8mk3's connected to the monitor L/R outputs.

Four SRM450v2 powered speakers are used as stage monitors for the band; they are connected to the aux 1-4 send jacks. An SRM150 powered speaker receives a mono input from the aux 5 send, and is used as a monitor for Chris (the keyboard player). Graphic EQs are connected to aux inserts 1-4 to help prevent feedback.

The club is driven by connecting a pair of DLM12S powered subwoofers and a pair of DLM12 powered speakers to the main left and right outputs.

A laptop connects to the mixer via the USB port, allowing the 2-channel main mix to be recorded. Any music (iTunes®, mp3s, or other pre-recorded audio) may be played back from the laptop, as well. These can enter as either a source for the monitor and phones, or any available channels.

Typical Live Sound System

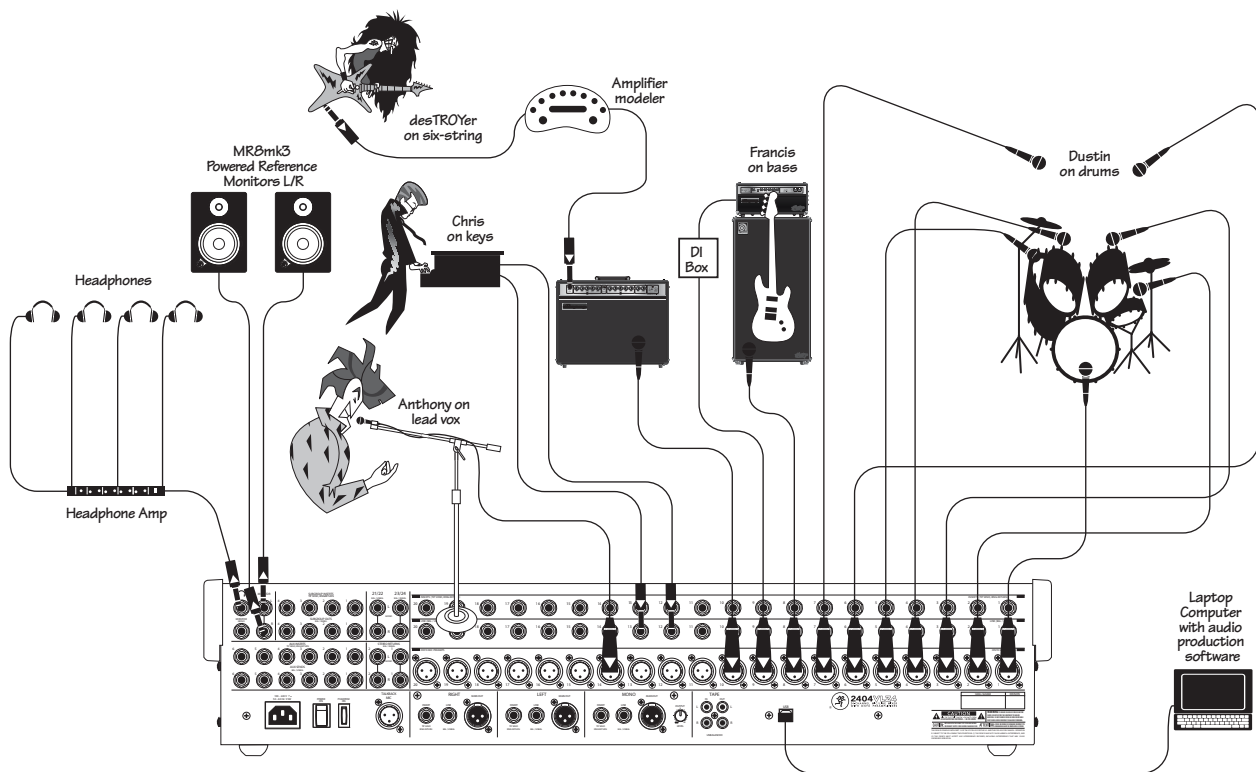

Once the band has played a few shows and feel that the songs are up to par, then it's time to record them for posterity and all three adoring fans. The good thing is that the VLZ4 4•Bus mixer functions great in both environments... live and recording!

Here is how to record the band in three easy steps:

1. Drum tracking: wire up everything as shown above. Bus the kick (panned left) to subgroup 1 and snare (panned right) to subgroup 2 so they are recorded to their own tracks in the DAW. They will show up on inputs 1 and 2. All four subgroup assign 1-2 Left/Right switches should be engaged so these signals may be monitored in mono. Bus the tom mics and overhead mics to subgroups 3 and 4; set the pans as preferred. The subgroup assign 3 left and subgroup assign 4 right switches should be engaged. These signals are recorded and monitored with the pan image as set up on the mixer and will show up as inputs 3 and 4. Check the levels carefully as they cannot be mixed later. The drums now need to be mixed in the DAW before overdubbing takes place.

2. Overdubbing: first, route the stereo USB return into the last stereo channel (23/24 or 31/32, depending on which VLZ4 4•Bus is being utilized). Next, route the stereo channel to the L/R Main so playback occurs in the headphones. Now route the bass to the L/R Main by sending the bass mic (panned left) to subgroup 1, and input 1 to track 5 of the DAW, while sending the bass DI (panned right) to subgroup 2, and input 2 to track 6 of the DAW. Finally, engage the subgroup assign 1 and 2 Left/Right switches to hear the bass in mono. Congratulations, you are overdubbing with zero latency!

3. Rinse and repeat: follow these same steps for guitars, keyboards, vocals, kazoos, llamas, and whatever else you can fit in the studio. It's that easy!

As the session progresses, the engineer, band, producer, A&R representative, and whatever posse may be present can crank the tunes through a pair of MR8mk3's and nod their collective heads to the beat.

Typical Recording System

VLZ4 4•Bus Features

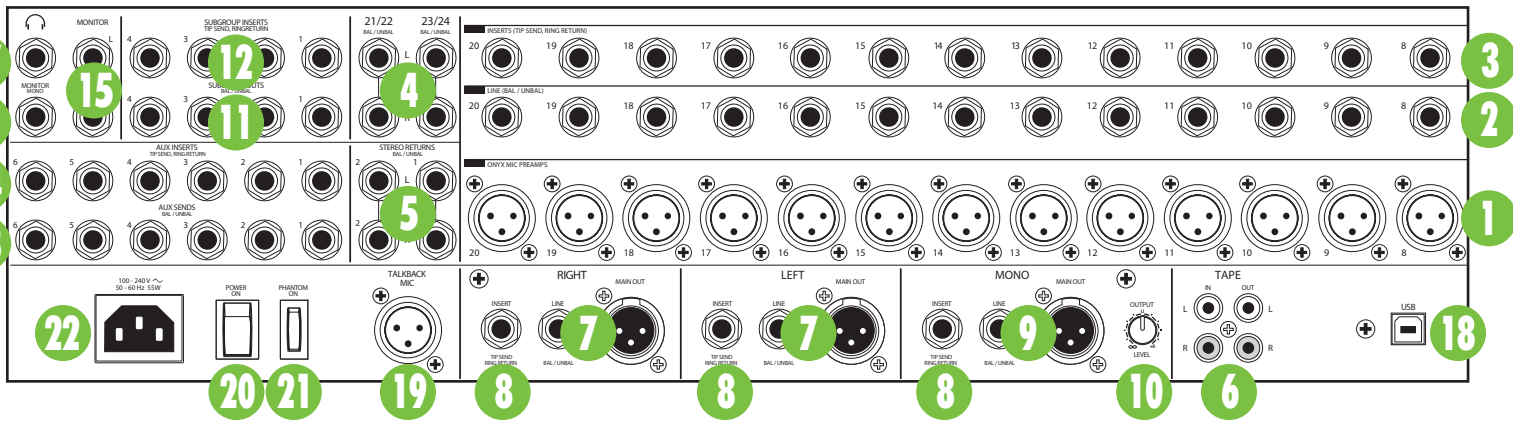

Rear Panel - Connections

1. Mic Ins

This is a female XLR connector that accepts a balanced mic or line level input from almost any type of source. These Onyx mic preamps feature higher fidelity and headroom rivaling any standalone mic preamp on the market today. These circuits are excellent at rejecting hum and noise.

The XLR inputs are wired as follows:

- Pin 1 = Shield or ground
- Pin 2 = Positive (+ or hot)
- Pin 3 = Negative (- or cold)

Professional ribbon, dynamic, and condenser mics all sound excellent through these inputs. The mic/line inputs will handle any kind of level you can toss at them, without overloading.

Microphone-level signals are passed through the mixer's splendid microphone preamplifiers to become line-level signals.

The Onyx preamps accept balanced line-level signals because the mixer is equipped with a -20 dB pad on channels 1-16 (2404VLZ4) and channels 1-24 (3204VLZ4) so hot signals may pass.

See Appendix B (page 31) for further details and some rather lovely drawings of the connectors you can use with your mixer.

Phantom Power

Most modern professional condenser mics require 48V phantom power, which lets the mixer send low-current DC voltage to the mic's electronics through the same wires that carry audio. (Semi-pro condenser mics often have batteries to accomplish the same thing.) "Phantom" owes its name to an ability to be "unseen" by dynamic mics (Shure SM57/SM58, for instance), which don't need external power and aren't affected by it anyway.

Phantom power may be selected by pressing up on the mixer's phantom [21] switch.



Never plug single-ended (unbalanced) microphones, or ribbon mics into the mic input jacks if phantom power is on. Do not plug instrument outputs into the mic XLR input jacks with phantom power on, unless you are certain it is safe to do so.

2. Line Ins

These 1/4" jacks share circuitry (but not phantom power) with the mic preamps, and can be driven by balanced or unbalanced sources.

To connect balanced lines to these inputs, use a 1/4" Tip-Ring-Sleeve (TRS) plug, wired as follows:

- Tip = Positive (+ or hot)
- Ring = Negative (- or cold)
- Sleeve = Shield or ground

To connect unbalanced lines to these inputs, use a 1/4" mono (TS) phone plug, wired as follows:

- Tip = Positive (+ or hot)
- Sleeve = Shield or ground

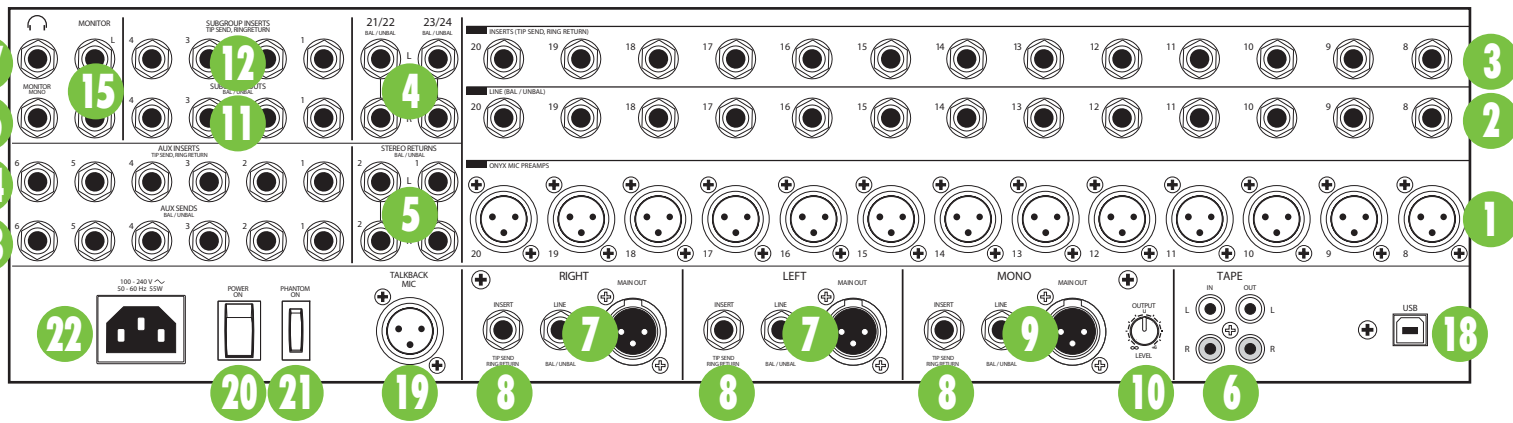

3. Insert

These unbalanced 1/4" jacks are for connecting serial effects processors such as compressors, equalizers, de-essers, or filters. The insert point is after the gain control [23] and low cut filter [24], but before the channel's EQ [31-36] and level [43]. The channel signal can go out of the insert jack to an external device, be processed and come back in on the same insert jack. To do this requires a standard insert cable that must be wired thusly:

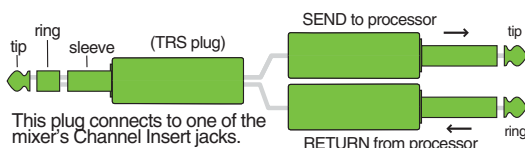

- Tip = Send (output to effects device)
- Ring = Return (input from effects device)
- Sleeve = Common ground

Insert jacks may be used as channel direct outputs; post-gain, and pre-EQ. See the connector section on page 30 (figure G) showing three ways to use insert cables.

4. Stereo Line Ins

The stereo line inputs are designed for 1/4" TRS balanced or 1/4" TS unbalanced signals. They may accept any line-level instrument, effects device, CD player, etc.

Level control is available -20 dB to +20 dB if you are connecting a mono source. Use the left (mono) stereo return input, and the mono signals will appear on both sides of the main mix.

5. Stereo Returns 1-2

The stereo (aux) returns are designed for 1/4" TRS balanced or 1/4" TS unbalanced signals, from -20 dB to +20 dB. They allow the stereo processed output from external effects processors or other devices to be added to the main mix.

Level adjustment of the incoming signals is made with the stereo return controls [54].

You may also use these inputs to add any stereo line-level signals to your main mix, so it could be another line-level source, not just an effects processor.

If you are connecting a mono source, use the left (mono) stereo return input, and the mono signals will appear on both sides of the main mix.

6. Tape Ins / Outs

The stereo unbalanced RCA inputs allow you to play a CD player, iPod® dock, or other line-level source. The tape in jacks accept an unbalanced signal using standard hi-fi hookup cables.

The stereo unbalanced RCA outputs allow you to record the main stereo mix onto a hard disk recorder or automatic CD burner, for example. This lets you make a recording for posterity/archive/legal purposes whenever the band gets back together again.

The tape output is the stereo main mix, and it is not affected by the main mix level control [75]. The output could also be used as an extra set of main outputs for feeding another zone.

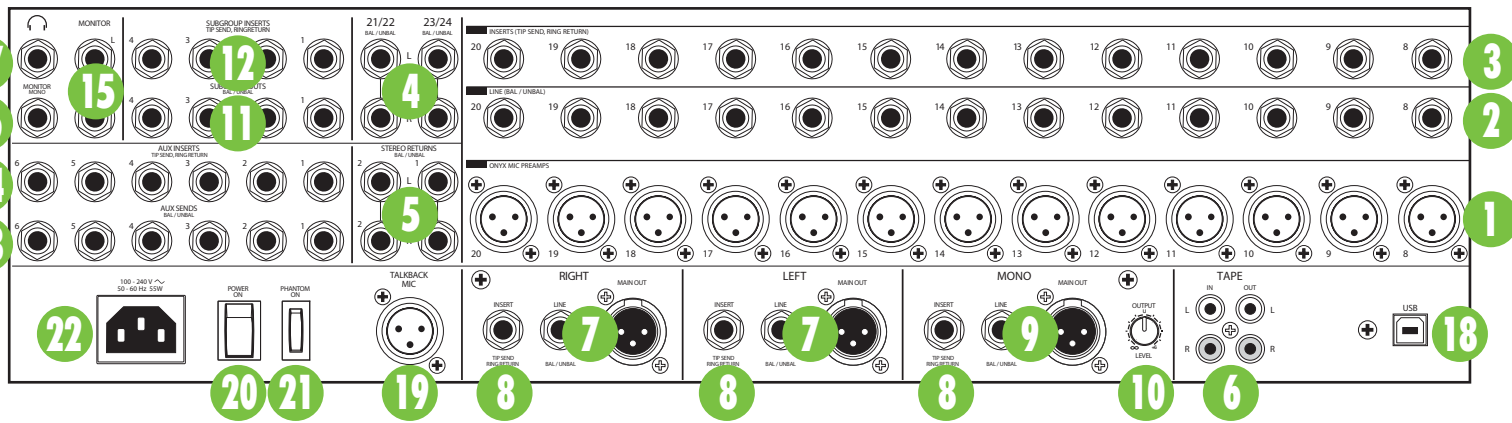

7. Left/Right Main Outs: XLR & 1/4"

The male XLR connectors provide a balanced line-level signal that represents the end of the mixer chain, where the fully mixed stereo signal enters the real world. Connect these to the left or right inputs of your main power amplifiers, powered speakers, or serial effects processor (like a graphic equalizer or compressor/limiter). The XLR outputs are 6 dB hotter than the TRS outputs.

The 1/4" TRS output connectors provide balanced or unbalanced line-level signals. Connect these to the next device in the signal chain like an external processor (compressor/limiter), or directly to the inputs of the main amplifier. These are the same signal that appears at the XLR main outputs, but 6 dB lower when the XLR is used balanced.

8. Main Inserts

These 1/4" TRS jacks are for connecting serial effects such as compressors, equalizers, deessers, or filters. The insert point is after the mix amps, but before the main mix fader [75]. Refer to the description of the channel insert on the previous page to see how to make this connection.

9. Mono Out

The male XLR connector [balanced] and 1/4" TRS output connector [balanced or unbalanced] provide a line-level signal that is a combination of the left and right main out [7] signals (L+R). You may use this for a separate mix that does not require a stereo feed, or to simply test the monaural compatibility of the stereo mix. Again, when used balanced, the XLR signal is 6 dB higher than that from the TRS jack.

10. Mono Out Level Control

This is a separate level control for the mono out [9]. It comes after the main mix fader [75], so turning the main mix fader up and down does affect the mono out signal. With this control turned all the way up, you will have 6 dB of extra gain at the mono out.

11. Group Outs 1-4

These 1/4" TRS jacks provide balanced or unbalanced line-level signals and are typically patched to the inputs of a multitrack deck, or to secondary amplifiers in a complex installation.

12. Group Inserts

These 1/4" TRS jacks are for connecting serial effects such as compressors, equalizers, de-essers, or filters. The insert point is after the mix amps, but before the group send masters [74] (and after the built-in stereo compressor [72]). Refer to the description of the channel insert [3] on the previous page to see how to make this connection.

13. Aux Sends 1-6

These 1/4" TRS connectors allow you to send balanced or unbalanced line-level outputs to external effects devices, headphone amplifiers, or stage monitors. These could either be passive stage monitors powered by an external amplifier, or powered stage monitors with built-in power amplifiers. All six auxes are independent of each other, so you can run up to six separate aux mixes.

Aux sends 3-4 may either be pre or post fader, depending on the position of the pre/post switches [28]. For stage monitor work, use pre, so the stage monitors do not increase in volume when the channel level is adjusted. Imagine how upsetting that can be to big hairy drummers. This allows you to set up the monitor mix and levels just right, and not have it change every time a channel level is adjusted.

For external processors, use post. In this way, the feed to external processors will vary with the channel level, so the level of any returned effect (like an echo) will also change if the channel level is changed, keeping them in the same ratio (wet/dry).

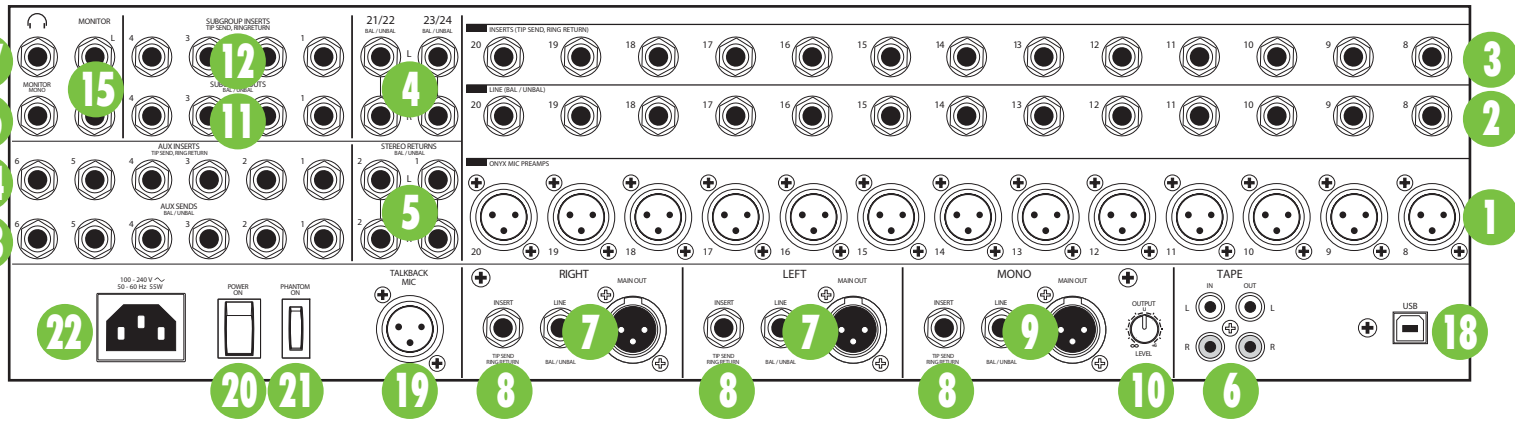

14. Aux Inserts

These 1/4" TRS jacks are for connecting serial effects such as compressors, equalizers, de-essers, or filters. The insert point is after the mix amps, but before the aux send masters [52] and the solo switch [60] (so you may hear the external processor when soloing the aux send). Refer to the description of the channel insert [3] on page 10 to see how to make this connection.

15. Left/Right Monitor Outs

These 1/4" TRS jacks provide a balanced line-level signal that may be used to provide an additional main mix output or to monitor soloed channels.

Connect these outputs to the inputs of an amplifier, powered speaker, headphone distribution amplifier, or recording device.

16. Mono Monitor Out

This 1/4" TRS output connector provides a balanced line-level signal that is a combination of the left and right monitor out [15] signals (L+R). You may use this for a separate mix that does not require a stereo feed, or to simply test the monaural compatibility of the stereo mix.

Connect these outputs to the inputs of an amplifier, powered speaker, headphone distribution amplifier, or recording device.

17. Headphone Out

This 1/4" TRS connector supplies the output to stereo headphones. It is the same signal that is routed to the monitor outputs [15-16]. The volume is controlled with the phones knob [69], right next to the monitor knob [68].

Whenever a solo switch [41, 49, 53, 55, 73] is engaged, you will only hear the soloed channel(s), 2-track return, aux(es), and/or group(s) in the headphones. This gives you the opportunity to audition the channels before they are added to the main mix. (Solo signals reaching the headphones are not affected by the channel level or main level (except in AFL mode), therefore turn down the phones level first, as soloed channels may be loud.)

The phones output follows standard conventions:

- Tip = Left channel
- Ring = Right channel
- Sleeve = Common ground



WARNING: The headphone amp is loud, and can cause permanent hearing damage. Even intermediate levels may be painfully loud with some headphones. **BE CAREFUL!** Always turn the phones level control [69] all the way down before connecting headphones or pressing a solo switch, or doing anything new that may affect the headphone volume. Then turn it up slowly as you listen carefully.

18. USB In/Out

The built-in USB interface allows for some powerful and flexible routing. It is a 4x2 interface allowing you to record up to four streams from the mixer, or to input stereo playback from a computer and route it to nearly any output or pair of outputs on the mixer. To use this feature with a PC, first download the PC ASIO driver from www.720trees.com. If connecting to a Mac, the mixer will show up as a 4x2 device with no driver required.

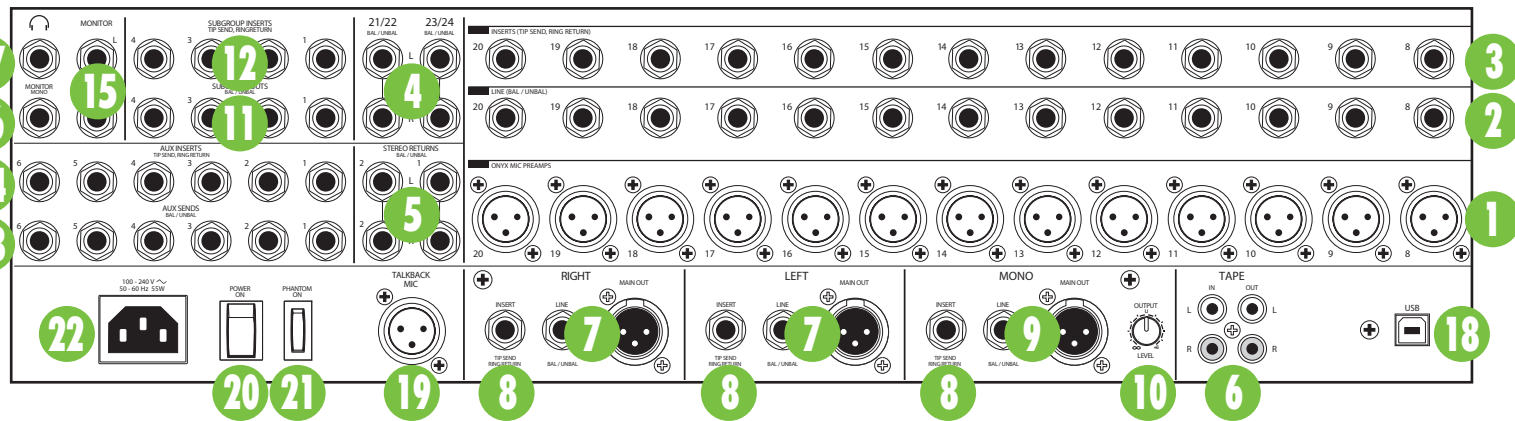

The USB routing capabilities are as follows:

USB input TO the mixer – playback:

(1) Stereo channel 23/24 (on the 2404VLZ4) and 31/32 (on the 3204VLZ4) features a USB button, so one may route computer output (such as iTunes®) down the last stereo channel of the board. This stereo signal may then be EQ'd, sent to auxiliaries (i.e. to feed monitors, headphones or effects) and is routable to mains and/or subgroups via the fader routing features that are available on all other channels. In short, this signal may be sent to nearly any desired output or pair of outputs. Additionally, the gain knob at the top of this channel strip adjusts the USB input level to the mixer to achieve an optimal signal level.

(2) The 2-Track Return section features a “flip” switch, so a “Tape” source (connected via RCA cables, such as an iPod®) or the USB signal from a computer (playing Windows Media Player® files, for example) may be routed to the main bus. This section also features a solo button and input level adjustment for fading house music up and down between bands, at a house of worship, or any other event where this may be necessary.

USB output FROM the mixer – recording, etc:

(1) A variety of different signals may be recorded via the USB output section, depending on the setup. In the 'USB OUT' section, the switch on the left [51] will select either Groups 1-2 or the main mix to feed USB output channels 1-2. The second switch (to the right) will select either Groups 3-4 or Aux 5-6 to feed USB output channels 3-4.

For example, with both USB output switches in the default position (up), true 4-track recording may be accomplished via routing to subgroups 1-4. The USB tap points for the subgroups are pre-fader (also pre-insert) and post-compressor. The signals will show up on the DAW dependent upon how they are panned on the channels.

In other words, if subgroups 1 and 2 are used to sub-mix drums and those drums have a stereo image (e.g. overheads and toms pan according to desire), this stereo image is retained in the DAW inputs (assuming subgroup 1 is set to "L" and subgroup 2 is set to "R"). Any adjustments made to the subgroup drum levels during the show only pertain to the live show itself; recording levels are not adjusted in the DAW unless they are adjusted on the channels. However, compression settings made on the mixer will apply to the recording.

Likewise, it is possible to record the main mix to take home a copy of the live show. These levels are also pre-main fader. Therefore, levels may be mixed up or down in the DAW later depending on the needs of the recording versus the live show. The end result is that fade-ins and/or fade-outs made during the show do not affect recorded levels.

And finally, it is possible to route the aux 5-6 (again, pre-fader) mixer signals into a DAW or plug-in host. From there, re-route the output of the DAW (or plug-in host) back into the mixer. Voilà...a powerful outboard effects unit!



Success here is partially dependent upon the computer's speed. It needs to be fast enough to run at low buffer sizes so that there is no noticeable latency between the input signal and, say, the reverb return. This kind of flexible routing allows for a variety of choices: running aux 5-6 as effects sends to outboard gear, internal effects sends (native to the board), DAW plug-ins (via USB) or as monitor mix feeds...a truly powerful feature! Be sure to review the software requirements on www.720trees.com to confirm that the latest device drivers are currently in use.

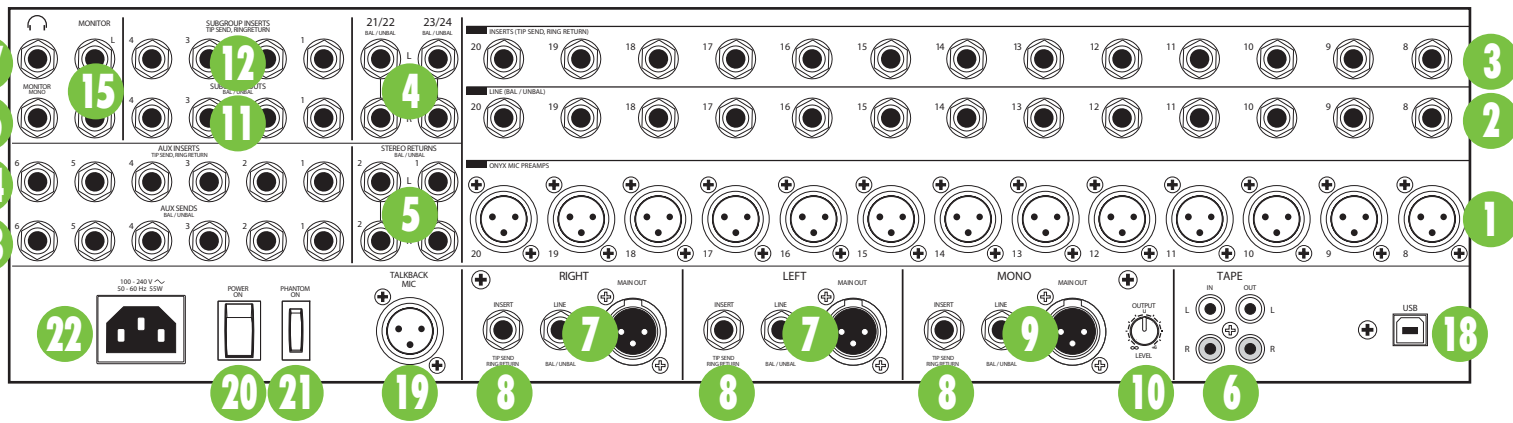

19. Talkback Mic

This is where to plug in an external talkback microphone. Dynamic and self-powered condenser microphones work well.

20. Power

Press the top of this rocker switch inwards to turn on the mixer. The front panel power LED [57] will glow with happiness, or at least it will if you have the mixer plugged into a suitable live AC mains supply.

Press the bottom of this switch to put the mixer into standby mode. It will not function, but some circuits are still live. To remove AC power, either turn off the AC mains supply, or unplug the power cord from the mixer and the AC mains supply.



As a general guide, you should turn on your mixer first, before any external power amplifiers or powered speakers, and turn it off last. This will reduce the possibilities of any turn-on, or turn-off thumps in your speakers.

21. 48V Phantom Power

Most modern professional condenser mics require 48V phantom power, which lets the mixer send low-current DC voltage to the mic's electronics through the same wires that carry audio. (Semi-pro condenser mics often have batteries to accomplish the same thing.) "Phantom" owes its name to an ability to be "unseen" by dynamic mics (Shure SM57/SM58, for instance), which don't need external power and aren't affected by it anyway.

Press the top of this switch in if your microphone requires phantom power. (Always check the position of this switch before connecting microphones.) A red LED [56] will illuminate just above the main mix meters [58] to indicate that phantom power is active. This is a global switch that affects all mic channels' XLR jacks at once.



Never plug single-ended (unbalanced) microphones, or ribbon mics into the mic input jacks if phantom power is on. Do not plug instrument outputs into the mic XLR input jacks with phantom power on, unless you know for certain it is safe to do so. Be sure the main level [75] is turned down when connecting microphones to the mic inputs when phantom power is turned on, to prevent pops from getting through to the speakers.

22. Power Connection

This is a standard 3-prong IEC power connector. Connect the detachable linecord (included in the box with your mixer) to the power receptacle, and plug the other end of the linecord into an AC outlet. The VLZ4 4•Bus Series Mixers have a universal power supply that can accept any AC voltage ranging from 100 VAC to 240 VAC. No need for voltage select switches. It will work virtually anywhere in the world. That's why we call it a "Planet-Earth" power supply! It is less susceptible to voltage sags or spikes, compared to conventional power supplies, and provides greater electromagnetic isolation and better protection against AC line noise.



Disconnecting the plug's ground pin is dangerous. Don't do it.

VLZ4 4•Bus Features

Front Panel - Channel Strip

The diagram illustrates the front panel controls for 8 channels, numbered 16 through 24. Each channel strip includes the following controls:

- Gain:** A rotary knob with settings for -20dB, 0dB (U), +20dB, and +40dB. Callout 23 points to this knob.
- Low Cut:** A switch for 100 Hz. Callout 24 points to this switch.
- Pad:** A switch for -20dB. Callout 25 points to this switch.
- Compressor:** A rotary knob with OFF and MAX settings. Callout 26 points to this knob.
- Aux:** Six rotary knobs labeled 1 through 6, with PRE and FX settings. Callout 27 points to knob 1, and callout 28 points to knob 2.
- EQ:** Four rotary knobs for HI 12k, MID, FREQ (200, 800, 2k), and LOW 80Hz. Callout 29 points to the HI 12k knob, callout 30 to the MID knob, callout 31 to the FREQ knob, and callout 32 to the LOW 80Hz knob.
- Pan:** A rotary knob with L and R settings. Callout 33 points to this knob.
- Mute:** A switch. Callout 34 points to this switch.
- Faders:** Two vertical sliders for SOLO and LR. Callout 35 points to the SOLO slider, callout 36 to the LR slider, callout 37 to the SOLO slider, and callout 38 to the LR slider.
- FX:** Two rotary knobs labeled FX1 and FX2. Callout 39 points to FX1, and callout 40 points to FX2.
- USB:** A switch. Callout 41 points to this switch.
- Mute ALT:** A switch for channels 21/22 and 23/24. Callout 42 points to this switch.

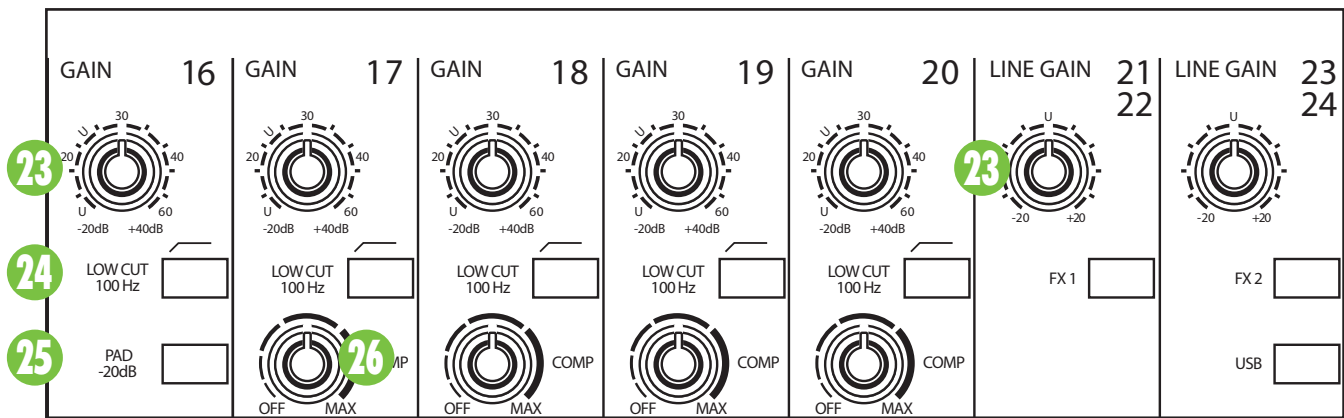

Channel Controls

The vertical channel strips look very similar, and have only a few differences between them. Each channel works independently, and just controls the signals plugged into the inputs directly behind it.

“U” like Unity gain

VLZ4 mixers have a “U” symbol on almost every level control. It stands for “unity gain,” meaning no change in signal level. The labels on the controls are measured in decibels (dB), so you’ll know what you’re doing level-wise if you choose to change a control’s settings.

23. Gain Control

If you haven’t already, please read the getting started section on page 6.

The gain knobs adjust the input sensitivity of the mic and line inputs. This allows signals from the outside world to be adjusted to run through each channel at optimal internal operating levels.

If the signal originates through the mic XLR jack, there will be 0 dB of gain with the knob fully down, ramping to 60 dB of gain fully up.

Through the 1/4" line input of channels 1-20 (2404VLZ4) and channels 1-28 (3204VLZ4), there is 20 dB of attenuation fully down and 40 dB of gain fully up, with unity gain “U” at 10:00.

Through the 1/4" line input of channels 21/22 (2404VLZ4) and 29/30 and 31/32 (3204VLZ4), there is 20 dB of attenuation fully down and 20 dB of gain fully up, with unity gain “U” at 12:00.

This 20 dB of attenuation can be very handy when you are inserting a hot signal, or when you want to add EQ gain, or both. Without this “virtual pad,” there is more chance of channel clipping.

24. Low Cut

All mono channels have a low-cut switch (often referred to as a high-pass filter) that cuts bass frequencies below 100 Hz at a rate of 18 dB per octave.

We recommend that you use low-cut on every microphone application except kick drum, bass guitar, or bassy synth patches. These aside, there isn’t much down there that you want to hear, and filtering it out makes the low stuff you do want much more crisp and tasty. Not only that, but low-cut can help reduce the possibility of feedback in live situations, and it helps to conserve amplifier power.



Another way to consider low-cut’s function is that it actually adds flexibility during live performances. With the addition of low-cut, you can safely use low equalization on vocals. Many times, bass shelving EQ can really benefit voices. Trouble is, adding low EQ also boosts stage rumble, mic handling clunks and breath pops from way-down low. Applying low-cut removes all those problems, so you can add low EQ without blowing your subwoofers.

25. Pad (-20 dB) Switch

In most cases, the pad switch will be disengaged. However, microphones and balanced line-level signals that produce a higher output than usual may require that the gain control [23] is turned way down. If this is the case, engage the pad switch to allow an additional 20 dB at the input to the mic preamp. This prevents overloading the microphone preamp and provides better gain control. The pad only applies to XLR inputs, not the 1/4" TRS inputs.

26. Compressor

Each of the last four mono channels in the VLZ4 4•Bus mixer has an in-line compressor circuit with a variable threshold. This is very useful for compression of vocals, and snare drums, for example, so you might consider connecting your microphones and drum mics to these channels, rather than other channels.

When the incoming signals exceed the threshold level set by this knob, the signal level is automatically compressed. This reduces the dynamic range, and reduces the chance of distortion due to overloading the input signals.



Dynamic range is the difference in level between the quietest and loudest parts of a song. A compressor “squeezes” the dynamic range, resulting in an overall steadier, more constant volume level for the signal. It helps sources, such as vocals, “sit” properly in the mix; it is very useful for live sound.

The compression ratio is fixed at around 6:1, with a soft knee response. The threshold may be adjusted clockwise from off (no compression) to 0 dBu (max).

As an example, suppose the threshold is set to maximum. An incoming signal reaches the threshold of 0 dBu. As it increases beyond the threshold, it becomes compressed at a ratio of 6:1. This means that even if the input further increases by 6 dB, the actual output only increases by 1 dB. This compresses the output signal, so there is more protection to your system from distortion and overload due to poor microphone technique (say it ain't so) and general pops, bangs and heavy metal screaming. The soft knee means that the compression slowly ramps up to 6:1 from the threshold. It does not jump abruptly to 6:1, as this would be hard knee compression, and harder on the ears too.

The graph on this page shows the input signal level going into the compressor, versus the output level coming out of it. It is the typical graph to see when compressors are discussed, and is just the kind of thing our engineers like to discuss during the company Christmas party*.

If the compressor is off, then the input = output. For example an input signal level of +5 dBu results in an output level of +5 dBu. The diagonal line from lower left to upper right represents $x = y$, that is, input = output.

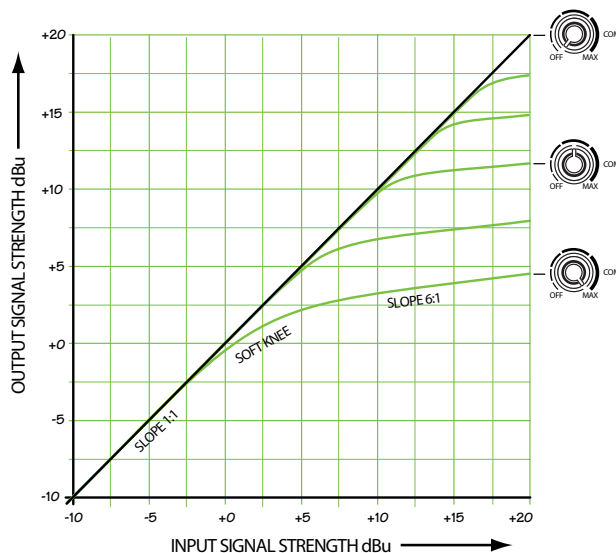

At the maximum compression, the threshold is set at 0 dBu, and the input to output relationship is represented by the lower curve. If the input is -5 dBu (that is, below the threshold), the output is -5 dBu. As the input reaches 0 dBu, the output is a bit less than 0 dBu. If the input is +5 dBu, the output is about +2 dBu. If the input reaches +10 dBu, then the output is +3 dBu. Notice the shapely curve of the soft knee between the diagonal slope of $x = y$ and the compressor slope of 6:1 (the compression ratio).

The other blue curves represent in-between positions of the compressor knob, with higher thresholds before compression begins.

Outboard compressors often have controls such as compression ratio, threshold, soft knee/hard knee, attack time, and release time. These last two affect how quickly the compressor kicks in when the input exceeds the threshold, and how quickly it is released after it drops below the threshold. In this compressor, these parameters are specially chosen to give you the best overall performance.

Adjust the threshold carefully, so your dynamic range is still lovely, without distortion or overload during the performance. Run through a few practice screams and high-notes, and adjust the compression as required.

* My High School math teacher, Mr. Marvin, thought that graphs might come in handy for me one day. Finally!

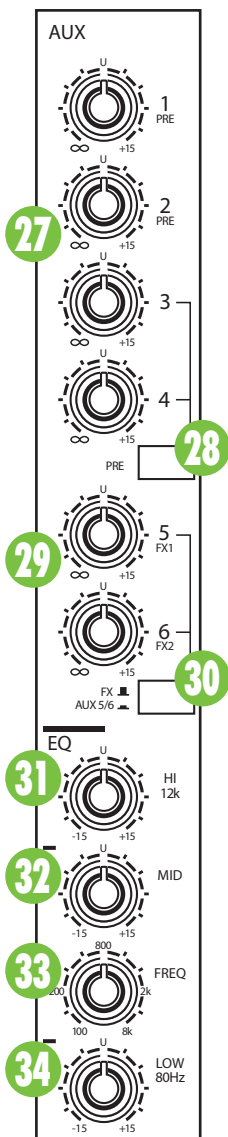

Mono channel

27. Aux Sends 1-6

These controls allow you to set up to six independent mixes, typically for running stage monitors or external effects processors.

The controls are off when turned fully down, deliver unity gain at the center, and can provide up to 15 dB of gain turned fully up. Chances are that you will never need this extra gain, but it's nice to know that it's there if you do.

Aux Sends 1-6 [13] are line-level outputs, and are used if you want to connect external processors, powered stage monitors, or external power amps with passive stage monitors. Stereo Returns 1-2 [5] are line-level inputs, typically used to return the output from external processors back to the main mix.

Carefully adjust how much of each channel appears in your aux mixes. For example, if you are running stage monitors, and someone wants “more me, and less them,” adjust these carefully.

Aux sends 3-4 can either be pre or post fader, depending on the position of the aux pre/post switches [28].

For stage monitor work, use pre, so the stage monitors do not increase in

volume when the channel level is adjusted. For external processors, use post. In this way, the feed to external processors will vary with the channel level, keeping them in the same ratio (wet/dry).

28. Pre-Fader / Aux Sends 1-2

Aux sends 1-2 are always pre-fader, designed for stage monitor applications. Aux sends 3-4 may be set to pre- or post-fader, so they may be used for monitors or effects.

Pre-fader: with the pre switch engaged (pressed in, not committed to marriage), aux 3 and 4 deliver signals post-insert, post-low cut, post EQ, post-mute and pre-fader. Any changes made to the channel controls, except the fader, will affect the aux send signal.

Post-fader: with the pre switch disengaged (up), aux 3 and 4 deliver signals post-insert, post-low cut, post-mute, post-EQ and post-fader. Any changes made to the channel controls will affect the aux send signal.

29. Int FX 1-2 / Aux Sends 5-6

These controls have dual functions depending on what your needs are at any given time. They allow you to send signal either to internal effects FX1 and FX2, or to aux 5 and aux 6, typically used for running stage monitors or external effects processors.

Aux Sends 5-6 (or FX1-2) are post-fader. Any changes made to the channel controls will affect the signal going to the internal effects processors or to the aux 5-6 output jacks [13]. Adjustments to the channel fader [43], gain [23] and channel EQ [31-36] will affect the feed going to the internal effects processors.

30. Int FX / Aux 5-6 Switch

This switch determines if that channel's controls [29, above] will be used for running the internal effects processors (engaged) or as aux 5-6 (disengaged).

Channel Equalization (EQ)

All VLZ4 4•Bus mono channels have 3-band EQ with shelving high, peaking mid with adjustable mid frequency and shelving low. The stereo channels have peaking hi-mid and peaking low-mid EQ controls in addition to the shelving high and shelving low EQ controls.

Shelving means that the circuitry boosts or cuts all frequencies past the specified frequency. For example, the low EQ boosts bass frequencies below 80 Hz and continuing down to the lowest note you never heard. Peaking means that certain frequencies form a “hill” around the center frequency.

With too much EQ, you can really upset things. We've designed a lot of boost and cut into each equalizer circuit because we know that everyone will occasionally need that. But if you max the EQ on every channel, you'll get mix mush. Equalize subtly and use the left sides of the knobs (cut), as well as the right (boost). If you find yourself repeatedly using a lot of boost or cut, consider altering the sound source, such as placing a mic differently, trying a different kind of mic, a different vocalist, changing the strings, or gargling.

31. High EQ

The high EQ provides up to 15 dB of boost or cut above 12 kHz, and it is also flat (no boost or cut) at the detent. Use it to add sizzle to cymbals, an overall sense of transparency, or an edge to keyboards, vocals, guitar and bacon frying. Turn it down a little to reduce sibilance or to mask tape hiss.

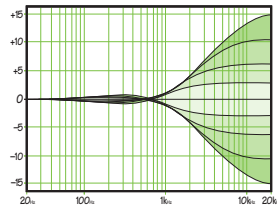

32. Mid EQ And 33. Freq (Mono Channels Only)

The mono channels employ a semi-parametric mid-sweep EQ. The gain (up to 15 dB of boost or cut) is set via the mid eq [32], and then “aimed” at a specific frequency, from 100 Hz to 8 kHz, via freq [33].

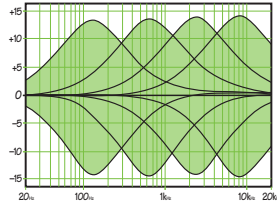

34. Low EQ

The low EQ provides up to 15 dB of boost or cut below 80 Hz. The circuit is flat at the center detent position. This frequency represents the punch in bass drums, bass guitar, fat synth patches, and some really serious male singers who eat raw beef for breakfast.

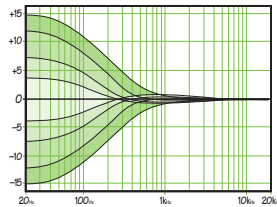

35. High Mid EQ Level (Stereo Channels Only)

The high mid EQ provides up to 15 dB of boost or cut at 2.5 kHz, and it is flat at the detent. Midrange EQ is often thought of as the most dynamic because the frequencies that define any particular sound are almost always found within this range. For example, the female vocal range as well as the fundamentals and harmonics of many higher-timbred instruments.

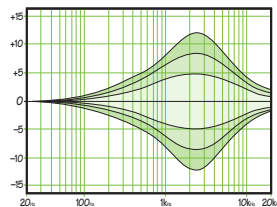

36. Low Mid EQ Level (Stereo Channels Only)

The low mid EQ provides up to 15 dB of boost or cut at 400 Hz, and is flat at the detent. Frequencies affected typically include the male vocal range as well as the fundamentals and harmonics of many lower-timbred instruments.

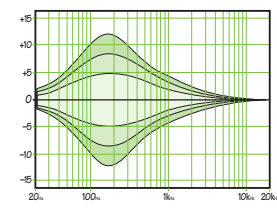

37. Pan

This control allows you to adjust how much of the channel signal is sent to the left versus the right outputs.

With the knob panned hard left, the signal feeds the main left, group 1, or group 3 busses, depending on the setting of the assign switches [42]. With the knob panned hard right, the signal feeds the main right, group 2, or group 4 busses, again dependent on the setting of the assign switches [42].

The balance control employs a design called “Constant Loudness.” If you have a channel panned hard left (or right) and then pan to the center, the signal is attenuated about 3 dB to maintain the same apparent loudness. Otherwise, it would make the sound appear much louder when panned center. This control is properly called “BAL” for balance in the stereo channels.

38. Mute

Mute switches do just what they sound like they do. They turn off the signal by “routing” it into oblivion. Engaging a channel's mute switch (almost) provides the same results as turning the fader all the way down (a pre-aux send is not affected by the channel fader, but it is by the mute switch). Any channel assignments to main mix, group 1-2, or group 3-4 will be interrupted and all of the aux sends will be silenced (both pre- and post-fader). The channel insert [3] will continue to provide a signal when a channel is muted. The OL LED [39] will illuminate when a channel's mute switch is engaged.

39. OL LED

This LED indicates the channel's signal level after the gain and EQ controls, but just before the channel's level. So even if the level is turned down, you can see if the channel is being overloaded.

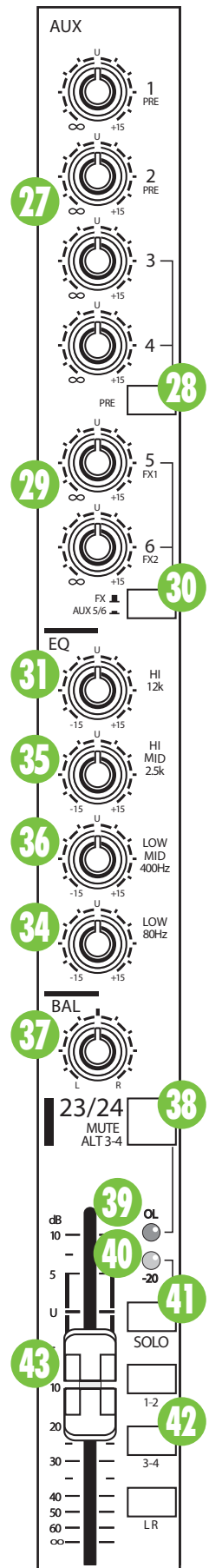

Stereo channel

The OL (overload) LED will come on when the channel's input signal is too high. This should be avoided, as distortion will occur. If the OL LED comes on regularly, check that the gain control [23] is set correctly for your input device, and that the channel EQ is not set with too much boost. The OL LED will also illuminate when a channel's mute switch [38] is engaged.

40. SIG LED

This LED also indicates the channel's signal level after the gain and EQ controls, but just before the channel's level. So even if the level is turned down, you can see if a signal is present.

The SIG (signal) LED will come on when the channel's input signal (at least -20 dBu) is present. It should illuminate non-stop if signal above 0 dBu is present in that channel. This LED will be solid when a channel's solo switch [41] is engaged.

41. Solo

Whenever a channel's solo switch is engaged, you will hear only the soloed channel(s) in the headphones and monitor outputs. This gives you the opportunity to audition the channels before they are added to the main mix. In PFL mode you can hear the solo signal, even when the channel's fader is down.

Solo is also used to set the gain of each channel correctly. When a channel is soloed, adjust the channel gain [23] until the input source reaches the level of the 0 dB LED of the left meter. Select PFL on the SOLO MODE switch [60] for gain setting.



Solo signals reaching the headphones and monitor outputs are not affected by the channel level (unless the SOLO MODE switch is set to AFL) or main level; therefore, turn down the phones level [69] and monitor level [68] first, as soloed channels may be loud.

The rude solo light [59] will turn on as a reminder that what you are listening to in the headphones and control room is just the soloed channel(s), 2-track return, stereo return(s), aux(es), and/or group(s). If the solo source is an input channel, that channel's SIG (signal) LED [40] will illuminate when that channel is soloed.

42. Assign

Alongside each channel fader are three buttons referred to as channel assignment switches. Used in conjunction with the channel's balance knob [37], they are used to determine the destination of the channel's signal.

With the pan knob at the center detent, the left and right sides receive equal signal levels (main mix L-R, group 1-2, and group 3-4). To feed only one side or the other, turn the pan knob accordingly.

If you are doing a mixdown to a 2-track, for example, simply engage the main mix switch on each channel that you want to hear, and they will be sent to the main mix bus. If you want to create a group of certain channels, engage either the 1-2 or 3-4 switches instead of the main mix, and they will be sent to the appropriate group faders. From there, the groups may be sent back to the main mix (using the group assign switches [73] above the group faders [74]), allowing you to use the group faders as a master control for those channels.

If you are creating new tracks or bouncing existing ones, you will also use the 1-2 and 3-4 switches, but not the main mix switch. Here you do not want the groups sent back into the main mix bus, but sent out, via the group out jacks [11], to your multitrack inputs.

43. Channel Fader

This is the last control in a channel's signal path, and it adjusts the level of each channel onto the main mix. The "U" mark indicates unity gain, meaning no increase or decrease of signal level. All the way up provides an additional 10 dB, should you need to boost a section of a song. If you find that the overall level is too quiet or too loud with the level near unity, check that the gain control [23] is set correctly.

44. FX1 and FX2

When engaged, these switches, located just below the stereo channels' gain controls [23], indicate that you want to return the internal FX processor signal to the stereo channel. The TRS inputs are disengaged when the switch is depressed.



Remember to turn the FX processor level controls to aux 1/2 and main all the way down to avoid double-bussing the FX return.

See Appendix E (page 37) for a list of the effects provided and a description of each one.

45. USB Switch

The USB switch on the last stereo channel provides stereo playback of iTunes®, or a DAW via the USB connection. Like any other input, this signal may also be EQ'd, sent to an aux bus, or mixed in with the other signals and assigned to subgroups or main outs. This switch overrides both the TRS inputs [5] and the FX2 switch [44].

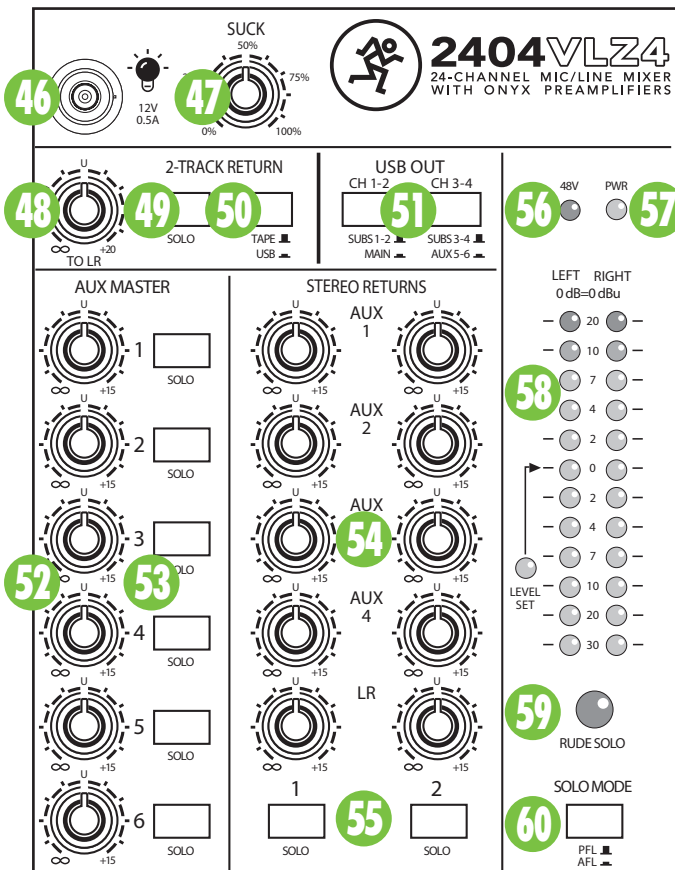

2-Track, USB, Aux Masters and Meters

This section includes the 2-track returns, USB, aux masters and stereo returns, and the meters. A 4x2 USB recording and playback function is at your disposal. This means up to four signals may be recorded simultaneously and a stereo mix returned to the mixer for playback.

The six auxes receive signals from the channels via the channel aux sends [27, 29]. Auxes 1-4 may also be fed from stereo returns 1-2 [54] and talkback [70, 71] and aux 1-2 may get internal effects processor output via the FX to AUX controls [62]. Any or all of these signals are mixed together, sautéed to a turn and sent out the aux send jacks [13] after the optimum output level is determined by the aux masters [52]. Aux sends from the channels are pre-fader (aux 1-2), selectable pre- or post-fader (aux 3-4), and post-fader (aux 5-6). All are post-EQ.

Post-fader aux sends may be fed to the inputs of an external processor like a reverb or digital delay. From there, the outputs of this external processor are fed back to the mixer's stereo return jacks [5]. Then these signals are sent through the stereo return level controls [54], and finally delivered to the main mix or to auxes 1-4 to add effects to monitors if so desired by the talent ["More me! More reverb!"].

So, the original unprocessed "dry" signals go from the channels to the main mix, and the processed "wet" signals go from the stereo returns to the main mix, and once mixed together, the dry and wet signals combine to create a glorious sound!

Pre-fader aux sends are typically used to provide another mix for stage monitors. If no external effects are being used, the stereo returns can be used as additional stereo inputs, or not used at all.

Read on to learn more about these features...

46. Lamp

This female BNC connector provides 12 volts DC with the center pin positive. Connect any quality gooseneck lamp here.

47. Suck Knob

If the band performing asks you if you can make them sound better, reply with a resounding "yes, indeed I can make you sound better...I will turn down the Suck Knob [47] which will do wonders for your band!"

As seen, it is broken down in percentages, from 0% suck (turned fully counter-clockwise) to 100% suck (turned fully clockwise). This way you get to determine the 'Suck Factor Percentage' (SFP) of the band.

If they follow instructions, buy you beers, and are a swell bunch, turn the knob counter-clockwise. If the drummer hits the snare drum or the guitarist does a screaming harmonic dive-bomb while you're setting up mics on their respective equipment (and thusly helping to ruin your hearing...huh?), feel free to crank the knob clockwise.

48. 2-Track Return Level

This knob controls the overall level to the mains of the tape (RCA) or USB, depending on the position of the 2-track return tape/USB switch [50]. This knob's level ranges from off, through unity (center detent position), on up to 20 dB of extra gain (fully clockwise).

49. 2-Track Return Solo

This switch sends the 2-track return (tape or USB, depending on the position of the switch [50]) to the solo bus.

50. 2-Track Return Tape/USB

This determines if the 2-track return gets its signal from the RCA "tape" inputs (switch disengaged) or USB (switch engaged).

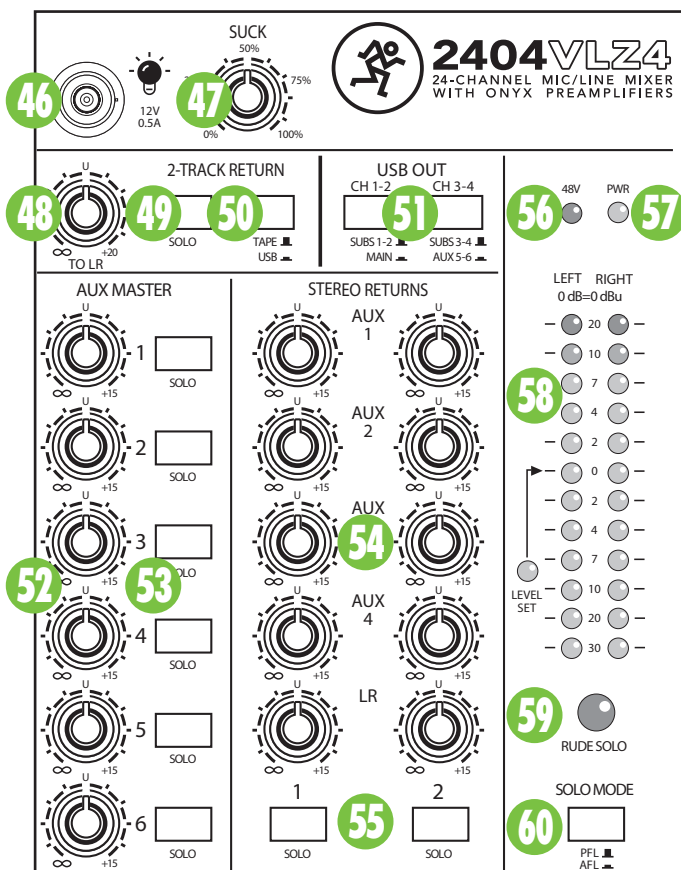

53. Master Aux Sends Solo

This button allows you to solo an individual aux send. If you are using the aux sends to feed your stage monitors, you may use these buttons to check your monitor mix. The rude solo LED [59] will flash to let you know the solo system is active.

The aux send solo is AFL and is not affected by the solo mode switch (PFL/AFL) [60], except that in PFL mode only the left meter indicates the signal.

54. Stereo Returns 1-2 to Aux 1-4/Main

These ten controls set the overall level of line signals received from the stereo return 1-2 inputs [5]. These controls range from off to +15 db of gain when fully clockwise, to compensate for low-level effects.

Signals passing through these controls go directly to the main mix and aux 1-4 buses where they are combined with signals from the channels.

55. Stereo Returns Solo

This button allows you to solo a stereo return. The rude solo LED [59] will flash to let you know that the solo system is active. Since this is an input, this signal is affected by the PFL/AFL master switch.

56. 48V LED

Most modern professional condenser mics require 48V phantom power, which lets the mixer send low-current DC voltage to the mic's electronics through the same wires that carry audio. (Semi-pro condenser mics often have batteries to accomplish the same thing.) "Phantom" owes its name to an ability to be "unseen" by dynamic mics (Shure SM57/SM58, for instance), which don't need external power and aren't affected by it anyway.

Phantom power for all mic inputs (except the talkback mic) may be selected by pressing up on the mixer's phantom [21] switch.

VERY IMPORTANT Never plug single-ended (unbalanced) microphones, or ribbon mics into the mic input jacks if phantom power is on. Do not plug instrument outputs into the mic XLR input jacks with phantom power on, unless you are certain it is safe to do so.

57. Power LED

This green LED will illuminate when the mixer is turned on, as a reminder of how on it really is. If it is not on, then it is off, and the mixer becomes a rather nice weight for keeping your morning newspaper from blowing away in the wind.

If it does not turn on, make sure the power cord is correctly inserted at both ends, the local AC mains supply is active, and the power switch [20] is on.

51. USB Out

These two switches allow for monstrous flexibility on the four recordable signals. The default switch configuration (disengaged) routes subgroups 1-4 over the USB connection to your favorite DAW software for a "mix it later" 4-track recording. Engaging the switch on the left allows the main L-R mix to be recorded for convenient stereo mixes of the show. The other switch allows aux 5/6 to be sent to the DAW for a unique stereo recording or the use of DAW plug-ins as effects.

52. Master Aux Sends 1-6

These knobs provide overall control over the aux send levels, just before they are delivered to the aux send outputs [13]. These knobs go from off to +15 db when turned all the way up.

This is usually the knob you turn up when the lead singer glares at you, points at his stage monitor, and sticks his thumb up in the air. (It would follow that if the singer stuck his thumb down, you'd turn the knob down, but that never happens.)



Keep in mind that aux sends 3-4 may either be pre- or post-fader, depending on the position of the channel's aux pre/post switch [28].

58. Left/Right Level Meters

These peak meters are made up of two columns of twelve LEDs, with three colors to indicate different ranges of signal level, traffic light style. They range from -30 at the bottom, to 0 in the middle, to +20 (CLIP) at the top.

When a channel is soloed in PFL, the right meter shows no reading, and the left meter shows the level of that channel's signal level, pre-fader.

In AFL, both left and right meters illuminate to indicate the 'After Fader Level' of the signal and stereo imaging. AFL is always used for outputs, regardless of the position of the PFL/AFL master switch, as you always want to view the output level after the fader.

The left meter's 0 dB LED is labeled "level set" to show where the level should be when adjusting a channel's gain [23] in the solo mode (as described in "Set the Levels" on page 6).

When 0 dBu (0.775 V) is at the main left and right TRS outputs [7], it shows as 0 dB on the meters.

You can get a good mix with peaks flashing anywhere between -20 and +10 dB on the meters. Most amplifiers clip at about +10 dBu, and some recorders aren't so forgiving either. For best real-world results, try to keep your peaks between "0" and "+7." Remember, audio meters are just tools to help assure you that your levels are "in the ballpark." You don't have to stare at them (unless you want to).

59. Rude Solo Light

This large red LED flashes when one or more solo switches are engaged [41, 49, 53, 55, 73]. This acts as a reminder that what you hear in the control room and headphones is the soloed channel(s), 2-track return, stereo return, aux(es), and/or group(s). If you forget that you are in solo mode, you can easily be tricked into thinking that something is wrong with your mixer. Hence, the rude solo light. Please forgive its rudeness, it is only trying to help, and wants to be your friend.

60. Solo Mode

Engaging a channel's solo switch [41] will cause this dramatic turn of events: Any existing source selection is immediately replaced by the solo signal, appearing at the monitor outputs [15, 16], phones [17] and at the left meter [58] (left and right meters when in AFL solo mode). The audible solo levels are then controlled by the solo knob [67]. The discrete level controls for headphones and monitor outputs are dependent on what is plugged in.

With the solo mode switch in the up position, you are in PFL mode, meaning Pre-Fader Listen. This mode is required for the "Set the Levels" procedure and is handy for quick spot-checks of channels, especially ones that have their faders turned down. PFL mode is only available to input signals. While in PFL mode, if an output is soloed, its signal will show up, but it will be an AFL signal.

With the solo mode switch down, you are in AFL mode, meaning After-Fader Listen. You will be able to hear the stereo output of the soloed channel – it will follow the channel's fader [43] and balance [37] settings. It is similar to muting all of the other channels, but without the hassle. AFL mode is the only soloing mode for subgroups and aux masters. Subgroups 1-2 or 3-4 may be soloed simultaneously for a true stereo image.

AFL is a new feature available to channel inputs and provides a mixdown solution that allows soloing the mix as it is on the faders.

In PFL mode, solo will not be affected by a channel's mute switch [38] position.



Remember, PFL mode taps the channel signal before the fader. If you have a channel's fader set way below "U" (unity gain), solo will not know that and will send a unity gain signal to the monitor outputs [15, 16], phones output [17], and meter display [58]. That may result in a startling level boost at these outputs when switching from AFL to PFL mode, depending on the position of the solo level knob [67].

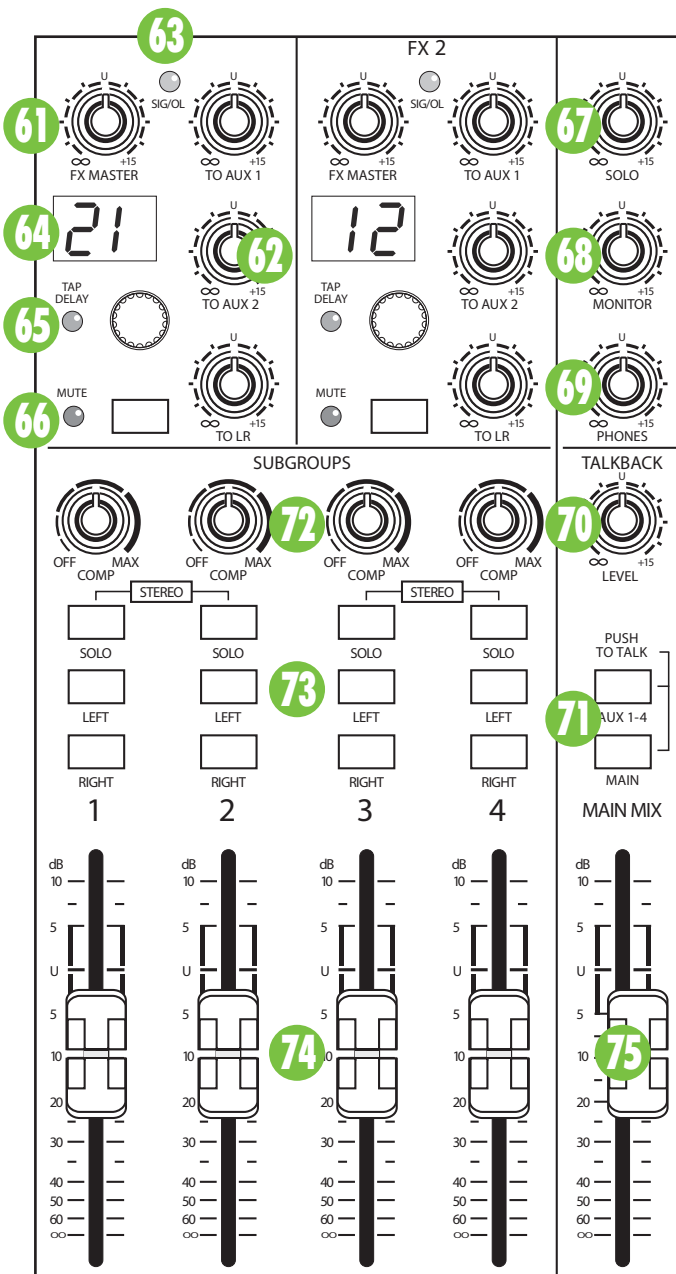

Stereo Effects Processors, Headphones, Talkback, Main and Groups Mix*

There are two identical Running-Man 32-bit internal effects processors. They are mono-in, stereo-out effects processors, with 24 presets each. Signals to these effects processors come from adjusting the FX1 and/or FX2 aux send [29] on each channel and the FX masters [61].

The stereo output from each processor may be added to the main mix using the 'FX to main' knob [62]. The stereo output from each processor may also be added to aux 1 and/or aux 2 by adjusting the 'FX to aux' control [62].

Or the FX returns may be routed to the stereo input channels [23/24 on the 2404 VLZ4, 31/32 on the 3204 VLZ4], using the the FX1 and/or FX2 switches [44]. This allows for way more flexibility. For example, you can EQ the FX and send them to any aux, group, or main. Just remember to turn the 'to aux 1', 'to aux 2' and 'to main' knobs [62] fully counter-clockwise to avoid double-bussing.

The talkback feature allows the engineer to communicate with the talent either through the phones output [17] or the aux 1-4 send outputs [13] using an external talkback microphone. This saves a lot of shouting over the audience's heads as you set up the talented one's stage monitors to their peculiarly-picky satisfaction.

61. FX1 and FX2 Send Master

These knobs control the level of the signals going into each internal effects processor. Adjust them carefully, keeping an eye on the adjacent sig/ol LED [63] to prevent overloading the effects processor.

62. FX1 and FX2 to Aux 1/Aux 2/Main

These knobs route the effects output to aux 1, aux 2 and mains independently. Use aux 1 and aux 2 to provide effects to monitors. Slowly add effects to the monitors by turning the 'to aux 1' and 'to aux 2' knobs clockwise. Use the aux master to monitor the amount sent. The FX output to the mains will be heard directly from the PA.

63. SIG/OL LED

These dual-LEDs illuminate green when the signal level going into each effects processor is within a good operating range (sig). They illuminate red if the effects processor is overloaded with too strong of a signal (ol). Turn down the send master levels [61] and check the channel sends if these light red regularly.

The signals going into the processors are affected by the channels' aux 5/6 sends [29], the channel gain [23], EQ [31-36], and channel faders [43], as well as the FX Send Master [61].

64. Preset Display

These displays show the number of the currently selected effects preset, as shown in the list of presets silkscreened above. Rotate the preset selector knob right or left to change a preset.

A new preset will be loaded approximately 1/4 of a second after you stop turning the knob, and it will be stored into the FX memory after about one second. When the VLZ4 4•Bus mixer is turned on, the FX section will load up the last-used preset.

* Affectionately referred to as "the meat 'n potatoes".

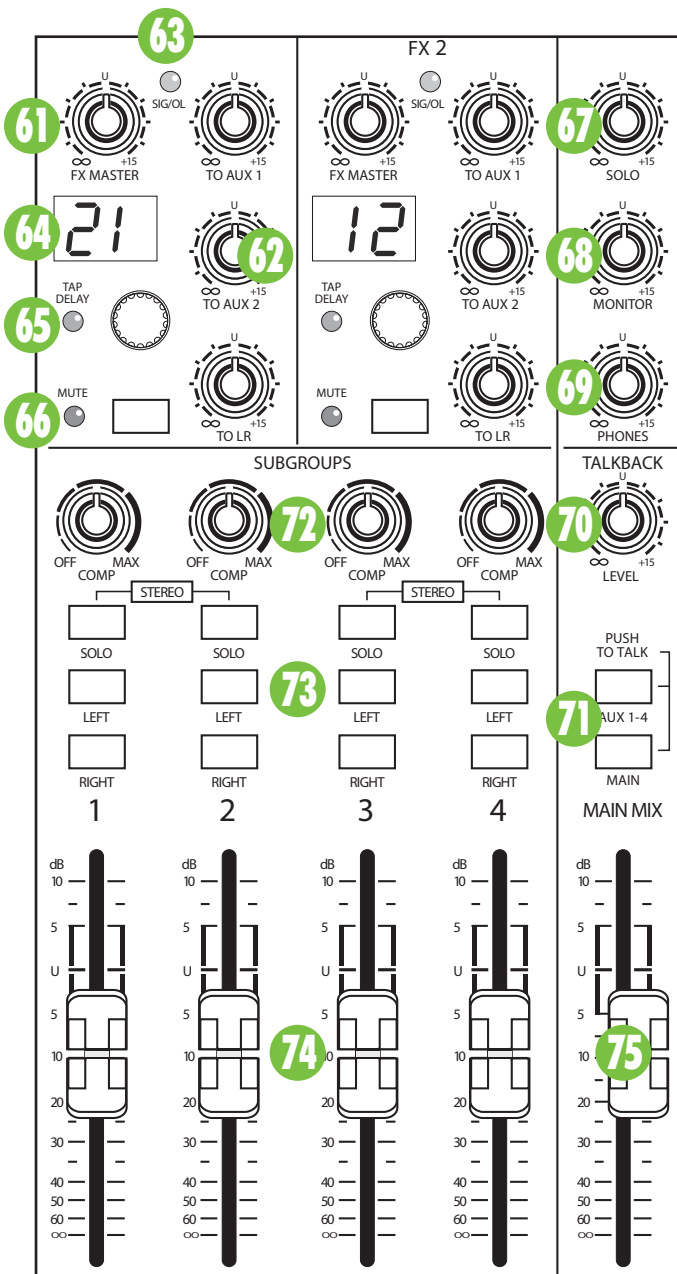

65. Preset Selector, Tap Delay and LED

Rotate these endless controls to select one of the 24 preset effects. When the rotation stops, that preset will be loaded and become operational. The current preset number is shown in the display [64]. The different presets are shown in the table to the right and on the silkscreen in the upper right hand corner of each VLZ4 4•Bus mixer. Further details of each preset are explained in Appendix E on page 37.

1	Plate Reverb
2	Vocal Plate
3	Warm Room
4	Bright Room
5	Warm Lounge
6	Small Stage
7	Warm Theater
8	Bright Stage
9	Warm Hall
10	Concert Hall
11	Cathedral
12	Gated Reverb

13	Chorus
14	Chorus + Reverb
15	Doubler
16	Tape Slap
17	Delay 1 Brt 350ms
18	Delay 1 Wrm 300ms
19	Delay 2 Brt 250ms
20	Delay 2 Wrm 200ms
21	Delay 3 Brt 175ms
22	Delay 3 Wrm 150ms
23	Chorus + Dly 300ms
24	Reverb + Dly 200ms

The knob also offers a tap delay function for presets 17-24. This works as follows:

1. Use the knob to select a preset from 17 to 24.
2. Press the knob in at least two times.

The DSP processor will calculate the time delay between the last two pushes, and it will assign this time interval to the echoes of the current digital delay.

The minimum tap delay is 50 ms and the maximum is 500 ms.

- If your taps are faster than 50 ms, they will be set to 50 ms.
- If taps are 500 ms to 1 second, they will be set to 500 ms.
- If taps are greater than 1 second apart, they will be ignored. Try again a bit faster.

3. The LED will flash in time with the new tap delay time.

66. Internal FX Mute

When engaged, the internal effects processor is muted, and its output will not appear on the main mix, monitor mix...or anywhere for that matter. The adjacent mute LED will come on as a reminder that the effects are muted. When power is first applied, these LEDs will illuminate and the FX will be muted for about 10 seconds while the little FX gerbils inside settle down.

If this switch is not engaged, then the internal effects are set free and may be added as required to the main mix, monitor mix and last two stereo channels.

67. Solo Level

This knob is used to adjust the volume of the soloed signal as it is routed to the monitor [15, 16] and phones [17] outputs. This control is independent of, and prior to, the monitor [68] and phones [69] level controls.

68. Monitor Level

This knob is used to adjust the volume at the monitor output [15, 16], from off to maximum gain (max).

69. Phones Level

This knob is used to adjust the volume at the phones output [17], from off to maximum gain (max). If solo is not active, the monitor, phones and meter are fed the post-fader main mix signal.



WARNING: The headphone amp is loud, and can cause permanent hearing damage. Even intermediate levels may be painfully loud with some headphones. **BE CAREFUL!** Always turn this control all the way down before connecting headphones, or pressing a solo switch [41, 49, 53, 55, 73], or doing anything new that may affect the headphone volume. Then turn it up slowly as you listen carefully.

70. Talkback Level

Use this knob to control the level of the talkback signal being routed to the main mix or aux 1-4 outputs, from the internal microphone.

1. Start with this control turned down.
2. Select the destination, either main mix and/or aux 1-4 [71], and make sure that their levels are already set nicely, using the main mix fader [75] or aux masters [52].
3. Slowly turn this control up until you get confirmation from whoever is listening that they can hear and obey your every command.

Once you have set the level, you can leave it there for the duration of the session or gig.

71. Push To Talk: Main, Aux 1-4

Push in the main switch to route the talkback signal to the main outputs. Use this to communicate with the talent in the studio through the headphones during a recording session.

The aux 1-4 switch routes the talkback signal to the aux send 1-4 outputs [13]. Use this to communicate with the musicians through their stage monitors when you are setting up a live performance.

It is fine to have both destination switches pushed in at the same time, so the talkback signal will be routed to both destinations. But if you don't have either of the destination switches engaged, the talkback signal won't go anywhere. You might as well be talking to a brick wall.



NOTE: The talkback destination switches are latching switches, not momentary. In other words, there is no need to hold down the switch(es) when using the talkback feature. Simply engage the switch(es) and begin talking. But don't forget to disengage the switch when you're done talking to them, or they may hear your unflattering remarks regarding their choice of apparel.



NOTE #2: The talkback will not work unless you have a microphone attached to the talkback mic input [19].

72. Compressor

Each of the four groups in the VLZ4 4•Bus mixer has an in-line compressor circuit with a variable threshold. This is very useful for compression of vocals, and snare drums, for example. See page 17 for an entire page (and a graph even!) dedicated entirely to explaining compression.

73. Groups Assign

One popular use of the groups is to use them as master faders for a group of channels on their way to the main mix [75]. Let us say you have a drum kit hogging up seven channels and you are going to want to control their group volume more conveniently. You do not want to try that with seven hands or seven fingers, so just un-assign these channels from the main mix and reassign them to groups 1-2, engage the assign to main mix left on group 1 and assign to main mix right on group 2. Now you may ride the entire drum mix with two faders – groups 1 and 2.

If you engage just one assign to main mix button per group (left or right), the signal sent to the main mix [75] will be the same level as the group outs [11]. If you want the subgroup to appear in the center of the main mix, engage both the assign to main mix left and right buttons. The signal will be sent to both sides, and reduced in level by 3 dB like a pan pot, so the overall level is the same, whether the group is assigned to main left, main right, or both.

Each group may also be soloed. This does not mean that each member of a group gets their shot at a solo and stardom. Rather, this allows you to listen to the group in isolation via monitor outputs or headphones. Being an output, these signals are AFL.

Groups 1-2 and 3-4 are paired together for purposes of solo and work together differently in pfl and afl modes. In pfl mode, since pfl is a mono bus, soloing Group 1 by itself, Group 2 by itself or both together will result in the same level solo signal, monaurally (assuming Groups 1 and 2 have the same levels of signal).

Afl is a stereo solo bus, so in afl mode, soloing Group 1 by itself places the signal on the left, Group 2 shows up on the right, and soloing both yields a stereo image, with Group 1 on the left and Group 2 on the right, and each reduced by 3 dB, not unlike using one of the channels' balance pots to center the signal. Groups 3 and 4 function similarly.



Solo signals reaching the headphones and monitor outputs are not affected by the channel level or main level; therefore, turn down the phones level [69] and monitor level [68] first, as soloed channels may be loud.

The rude solo light [59] will turn on as a reminder that what you are listening to in the headphones is just the soloed group(s).

74. Group 1-4 Faders

As you might expect, these faders control the levels of the signals sent to the group outs [11]. All channels that are assigned to groups, not muted, and not turned fully down will appear at the group outs.

The group signal is off when its fader is fully down, the “U” marking is unity gain, and fully up provides 10 dB additional gain. Remember that if you are treating two groups as a stereo pair, group 1 and 2 for example, make sure that both group faders “ride” together to maintain the left/right balance.

75. Main Mix

This stereo fader allows you to adjust the levels of the main mix signals sent to the XLR and 1/4" main line-level outputs [7], and the tape outputs [6].

This gives you the ultimate feeling of power and control over the sound levels sent to your audience. Adjust this control carefully, with your good eye on the meters to check against overloading, and your good ear to the levels to make sure your audience (if any) is happy.

The main mix signals are off with the fader fully down, the “U” marking is unity gain, and fully up provides 10 dB of additional gain. This additional gain will typically never be needed, but once again, it's nice to know that it's there. The fader is stereo, as it affects both the left and right of the main mix equally. This is the ideal control to slowly bring down at the end of a song (or quickly in the middle of a song if the need ever arises).

This control does not affect the aux outputs [13]. This does, however, conclude the main portion of the owner's manual. From here on out it's all appendices. You should pour yourself a cold, frosty one and pat yourself on the back for making it here!

Ok, congratulations are now over. Time to plug in your VLZ4 4•Bus mixer, power it on, and start twiddlin' some knobs!

Appendix A: Service Information

If you think your mixer has a problem, please check out the following troubleshooting tips and do your best to confirm the problem. Visit the Support section of our website (www.720trees.com) where you will find lots of useful information such as FAQs, documentation and any updated PC drivers, etc. You may find the answer to the problem without having to send your mixer away.

Troubleshooting

Bad Channel

- Is the channel EQ set up nicely?
- Is the channel gain set correctly?
- Is the channel level up enough?
- Is the channel OL led on?
- Is the channel balance set in the middle?
- Try the same source signal in another channel, set up exactly like the suspect channel.
- Is phantom power required for your microphone?

Bad Output

- Is the main level turned up?
- Are the EQs set to reasonable levels?
- Are any aux returns maxed out?
- Unplug anything from the other line-level outputs, such as monitor out, just in case one of your external pieces has a problem.
- Make sure that you are not overdriving your amplifiers. Check the loudspeaker average load impedance is not less than the minimum your amplifier can handle. Check the speaker wiring.

Noise

- Turn the channel gains down, one by one. If the sound disappears, it's either that channel or whatever is plugged into it, so unplug whatever that is. If the noise disappears, it's from your whatever.

Power

- The power LED should come on if the mixer is connected to a suitable live AC mains outlet, and the power switch is on. Check to make sure that the power cord is securely plugged in.

Repair

For warranty service, refer to the warranty information on page 39.

Non-warranty service is available at a factory-authorized service center. To locate the nearest service center, visit www.720trees.com, click "Contact Tech Support" and select "Locate a Service Center or Distributor" [3]. Service for VLZ4 mixers living outside the United States may be obtained through local dealers or distributors.

If you do not have access to our website, you can call our Tech Support department at 1-800-898-3211, Monday-Friday during normal business hours, Pacific Time, to explain the problem. Tech Support will tell you where the nearest factory-authorized service center is located in your area.

Appendix B: Connections

Balanced XLR Input Connector

The 802VLZ4 mixer has three female XLR inputs. Be sure the cables are wired per AES (Audio Engineering Society) standards:

Balanced XLR Input Connector

- Pin 1 – Shield (Ground)
- Pin 2 – Positive (+ or hot)
- Pin 3 – Negative (– or cold)

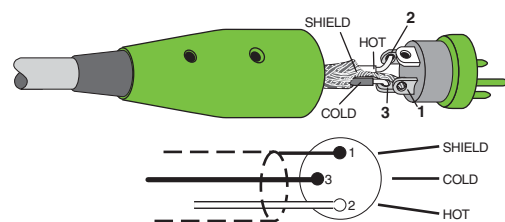

Balanced XLR Input Connector

Balanced XLR Output Connector

The male XLR connectors provide a balanced line-level signal that represents the end of the mixer, where the fully mixed stereo signal enters the real world. Connect these to the left and right line-level inputs of powered speakers or to the left and right line-level inputs of an amplifier (with speakers already attached). Be sure the cables are wired per AES (Audio Engineering Society) standards:

Balanced XLR Output Connector

- Pin 1 – Shield (Ground)
- Pin 2 – Positive (+ or hot)
- Pin 3 – Negative (– or cold)

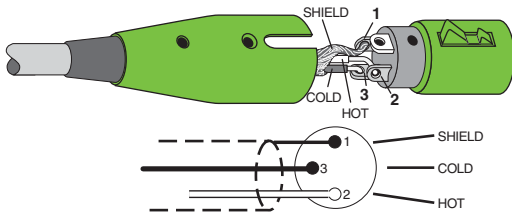

Balanced XLR Output Connector

Balanced 1/4" TRS Connector

TRS stands for Tip-Ring-Sleeve, the three connections available on a stereo 1/4" cable. This allows for a direct connection to the channel input jacks. Be sure the cables are wired per AES (Audio Engineering Society) standards:

Balanced 1/4" TRS Connector

- Sleeve – Shield (Ground)
- Tip – Positive (+ or hot)
- Ring – Negative (– or cold)

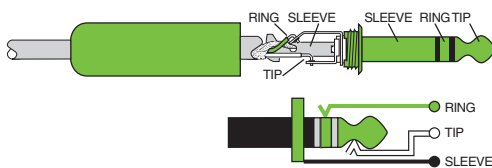

Balanced 1/4" TRS Connector

TRS jacks and plugs are used in several different applications:

- Balanced mono circuits. When wired as a balanced connector, a 1/4" TRS jack or plug is connected tip to signal high (hot), ring to signal low (cold), and sleeve to ground (earth).
- Stereo Headphones, and rarely, stereo microphones and stereo line connections. When wired for stereo, a 1/4" TRS jack or plug is connected tip to left, ring to right and sleeve to ground (earth). VLZ4 mixers do not directly accept 1-plug-type stereo microphones. They must be separated into a left cord and a right cord, which are plugged into the two mic preamps.

You can cook up your own adapter for a stereo microphone. "Y" two cables out of a female 1/4" TRS jack to two male XLR plugs, one for the right signal and one for the left.

- Unbalanced send/return circuits. When wired as a send/return "Y" connector, a 1/4" TRS jack or plug is connected tip to signal send (output from mixer), ring to signal return (input back into mixer), and sleeve to ground (earth).

Unbalanced 1/4" TS Connector

TS stands for Tip-Sleeve, the two connections available on a mono 1/4" cable. This allows for a direct connection to the channel input jacks. Be sure the cables are wired per AES (Audio Engineering Society) standards:

Unbalanced 1/4" TS Connector

- Sleeve – Shield (Ground)
- Tip – Positive (+ or hot)

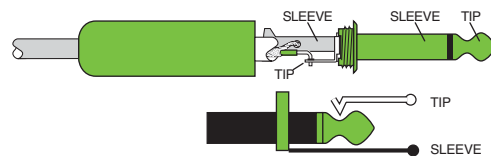

Unbalanced 1/4" TS Connector

TS jacks and plugs are used in many different applications, always unbalanced. The tip is connected to the audio signal and the sleeve to ground (earth). Some examples:

- Unbalanced microphones
- Electric guitars and electronic instruments
- Unbalanced line-level connections

Unbalanced RCA Connector

RCA-type plugs (also known as phono plugs) and jacks are often used in home stereo and video equipment and in many other applications. RCA plugs are unbalanced. Connect the signal to the center post and the ground (earth) or shield to the surrounding "basket." Be sure the cables are wired per AES (Audio Engineering Society) standards:

Unbalanced RCA Connector

- Sleeve – Shield (Ground)
- Tip – Positive (+ or hot)



Unbalanced RCA Connector

TRS Send/Receive Insert Jacks

Single-jack inserts are three-conductor, TRS-type 1/4" phone. They are unbalanced, but have both the mixer output (send) and the mixer input (return) signals in one connector. See the illustration below.

The sleeve is the common ground (earth) for both signals. The send from the mixer to the external unit is carried on the tip, and the return from the unit to the mixer is on the ring.

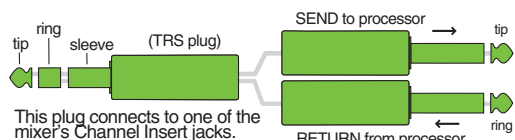

Unbalanced 1/4" Insert Connectors

Using the Send Only on an Insert Jack

If you insert a TS (mono) 1/4" plug only partially (to the first click) into a VLZ4 insert jack, the plug will not activate the jack switch and will not open the insert loop in the circuit (thereby allowing the channel signal to continue on its merry way through the mixer).

This allows you to tap out the channel or bus signal without interrupting normal operation.

If you push the 1/4" TS plug in to the second click, you will open the jack switch and create a direct out, which does interrupt the signal in that channel. See the illustration below.

NOTE: Do not overload or short-circuit the signal you are tapping from the mixer. That will affect the internal signal.

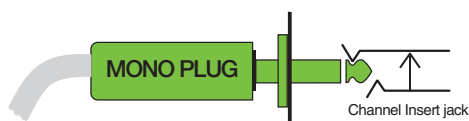

Direct out with no signal interruption to master.
Insert only to first click.

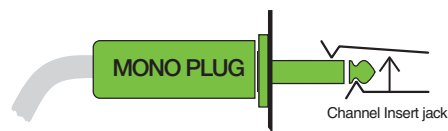

Direct out with signal interruption to master.
Insert all the way in to the second click.

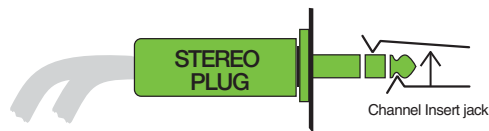

For use as an effects loop.
(Tip = Send TO effect, Ring = Return FROM effect).

Using the Send Only on an Insert Jack

Appendix C: Technical Information

Specifications

Noise Characteristics:

(Mic in to Insert Send out, max gain.)

150 Ω termination:	-128.5 dBu
---------------------------	------------

(20 Hz–20 kHz bandwidth, 1/4" Main out, channel gains @ unity gain, channel EQs flat, all channels assigned to Main Mix, odd channels panned left, even channels panned right.)

Main Mix fader unity, channel faders down:

2404:	-87.0 dBu (-91.0 dB Signal to Noise Ratio, ref +4 dBu)
3204:	-84.5 dBu (-88.5 dB Signal to Noise Ratio, ref +4 dBu)

Main Mix fader unity, channel faders @ unity:

2404:	-81.5 dBu
3204:	-80.0 dBu

Frequency Response:

Mic Input to Main Output (Gain @Unity)
+0, -1 dB, 20 Hz to 50 kHz
+0, -3 dB, <10 Hz to >100 kHz

Distortion (THD+N):

(1 kHz 15 dB gain, 20 Hz–20 kHz bandwidth)

Mic in to insert send:	<0.001%
Mic in to Main Out:	<0.005%

Attenuation and Crosstalk:

(1 kHz relative to +10 dBu, 20 Hz–20 kHz bandwidth, Mic in, 1/4" Main Out, Gain @ unity.)

Channel Mute switch engaged:	-90 dBu
Channel Fader down:	-88 dBu

Common Mode Rejection Ratio (CMRR):

(Mic in to Insert Send out, max gain.)

1 kHz:	better than -70 dB
--------	--------------------

Maximum Input and Output Levels:

Mic in:	+21 dBu
All other inputs:	+21 dBu
Main Mix XLR out:	+27 dBu
All other outputs:	+21 dBu

3-Band Equalization (mono channels)

Low:	± 15 dB @ 80 Hz
Mid:	± 15 dB sweep 100 Hz–8 kHz
High:	± 15 dB @ 12 kHz
Low Cut Filter:	18 dB/octave, -3 dB @ 100 Hz

4-Band Equalization (stereo channels)

Low:	± 15 dB @ 80 Hz
Low-Mid:	± 15 dB @ 400 Hz
High-Mid:	± 15 dB @ 2.5 kHz
High:	± 15 dB @ 12 kHz

USB

Format:	USB 1.1
I/O:	Stereo Input, 4 Channel Output
A/D/A:	24 bit, 44.1 kHz / 48 kHz

Input and Output Impedance:

Mic in:	2.7 k Ω
Channel Insert return:	2.5 k Ω
All other inputs:	10 k Ω or greater
Tape out:	<10 Ω
All other outputs:	120 Ω

AC Power Requirements:

Power Consumption:	55 watts (2404VLZ4) 65 watts (3204VLZ4)
Universal AC Power Supply:	100 VAC – 240 VAC, 50-60 Hz

Physical Dimensions and Weight

Front Height:	1.8 in / 46.3 mm (both)
Rear Height:	6.0 in / 153 mm (both)
Depth:	19.1 in / 486 mm (both)
Width:	29.4 in / 748 mm (2404VLZ4) 38.0 in / 964 mm (3204VLZ4)
Weight:	31 lb. / 14.1 kg (2404VLZ4) 39 lb. / 17.7 kg (3204VLZ4)

Since we are always striving to make our products better by incorporating new and improved materials, components, and manufacturing methods, we reserve the right to change these specifications at any time without notice.

The "Running Man" figure is a registered trademarks of LOUD Technologies Inc. All other brand names mentioned are trademarks or registered trademarks of their respective holders, and are hereby acknowledged.

Please check our website for any updates to this manual:
www.720trees.com.

©2013 LOUD Technologies Inc. All Rights Reserved.

Block Diagram

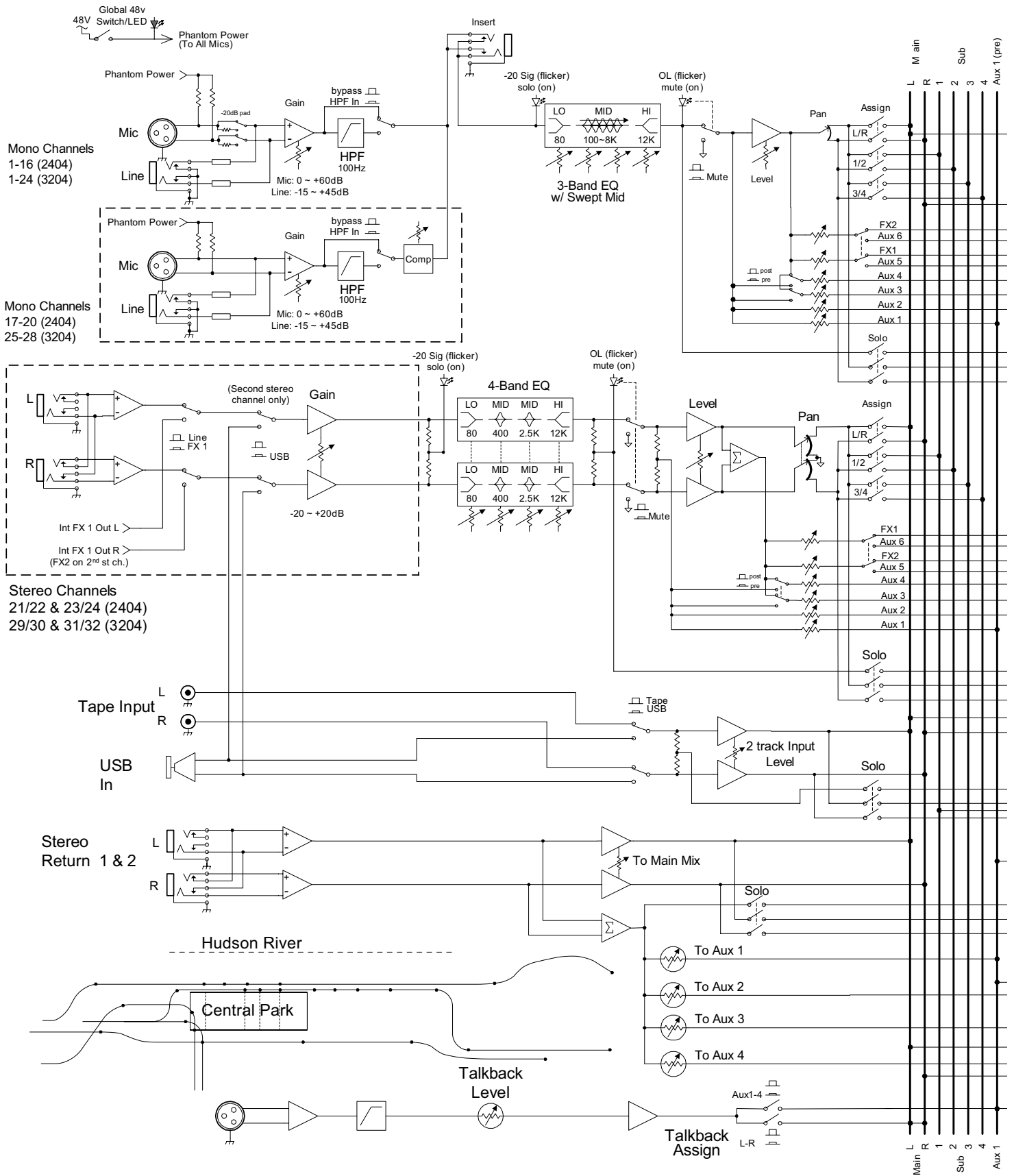

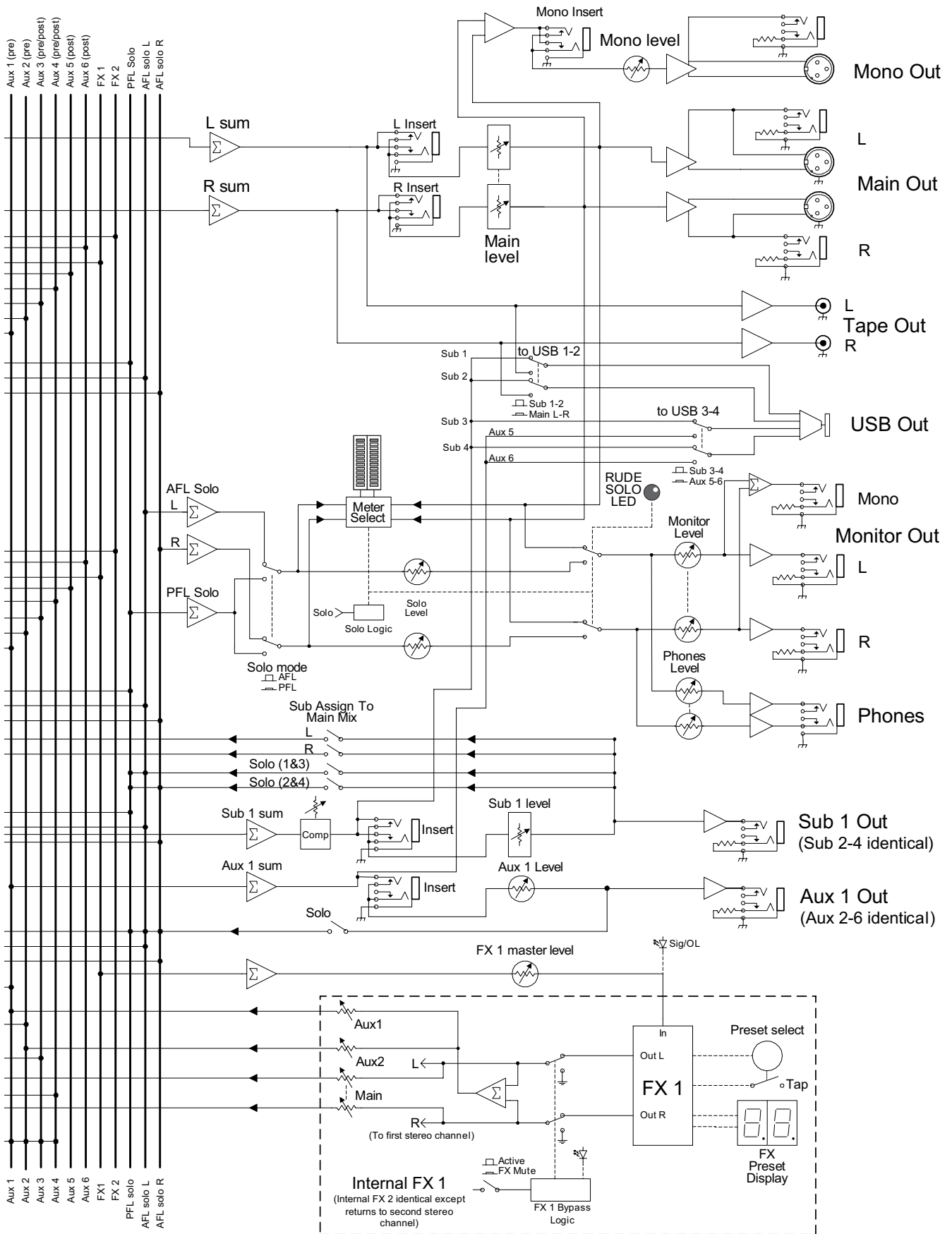

Track Sheet - Mono Channels

GAIN	7	GAIN	8	GAIN	9	GAIN	10	GAIN	11	GAIN	12	GAIN	13	GAIN	14
	LOW CUT 100 Hz	LOW CUT 100 Hz	LOW CUT 100 Hz	LOW CUT 100 Hz	LOW CUT 100 Hz	LOW CUT 100 Hz	LOW CUT 100 Hz	LOW CUT 100 Hz	LOW CUT 100 Hz	LOW CUT 100 Hz	LOW CUT 100 Hz	LOW CUT 100 Hz	LOW CUT 100 Hz	LOW CUT 100 Hz	LOW CUT 100 Hz
	PAD -20dB	PAD -20dB	PAD -20dB	PAD -20dB	PAD -20dB	PAD -20dB	PAD -20dB	PAD -20dB	PAD -20dB	PAD -20dB	PAD -20dB	PAD -20dB	PAD -20dB	PAD -20dB	PAD -20dB
AUX															
	PRE	PRE	PRE	PRE	PRE	PRE	PRE	PRE	PRE	PRE	PRE	PRE	PRE	PRE	PRE
	FX AUX 5/6	FX AUX 5/6	FX AUX 5/6	FX AUX 5/6	FX AUX 5/6	FX AUX 5/6	FX AUX 5/6	FX AUX 5/6	FX AUX 5/6	FX AUX 5/6	FX AUX 5/6	FX AUX 5/6	FX AUX 5/6	FX AUX 5/6	FX AUX 5/6
EQ															
	PAN	PAN	PAN	PAN	PAN	PAN	PAN	PAN	PAN	PAN	PAN	PAN	PAN	PAN	PAN
	MUTE	MUTE	MUTE	MUTE	MUTE	MUTE	MUTE	MUTE	MUTE	MUTE	MUTE	MUTE	MUTE	MUTE	MUTE
	SOLO	SOLO	SOLO	SOLO	SOLO	SOLO	SOLO	SOLO	SOLO	SOLO	SOLO	SOLO	SOLO	SOLO	SOLO
	1-2	1-2	1-2	1-2	1-2	1-2	1-2	1-2	1-2	1-2	1-2	1-2	1-2	1-2	1-2
	3-4	3-4	3-4	3-4	3-4	3-4	3-4	3-4	3-4	3-4	3-4	3-4	3-4	3-4	3-4
	LR	LR	LR	LR	LR	LR	LR	LR	LR	LR	LR	LR	LR	LR	LR

Track Sheet - Comp & Stereo Channels and Master Section

GAIN 17 **GAIN 18** **GAIN 19** **GAIN 20** **LINE GAIN 21** **LINE GAIN 23**

22 **24**

LOW CUT 100 Hz COMP OFF MAX

AUX 1 PRE 2 PRE 3 4 5 FX1 6 FX2

EQ HI 12k MID 800 FREQ 200 LOW 80Hz

PAN BAL

MUTE 17 MUTE 18 MUTE 19 MUTE 20 MUTE 21/22 MUTE 23/24

dB 10 5 0 -5 -10 -15 -20 -25 -30 -35 -40 -45 -50 -55 -60 -65 -70

OL -20 SOLO 1-2 3-4 LR

2404VLZ4
24-CHANNEL MIC/LINE MIXER WITH ONYX PREAMPLIFIERS

12V 0.5A

2-TRACK RETURN SOLO TAPE USB TO LR

USB OUT CH 1-2 CH 3-4 SUBS 1-2 MAIN SUBS 3-4 AUX 5-6

48V PWR

LEFT 0dB=0dBu RIGHT 20 10 7 4 2 0 2 4 7 10 20 30

RUDE SOLO SOLO MODE PFL AFL

FX 1 SIG/OL TO AUX 1 TO AUX 2 TO LR

FX 2 SIG/OL TO AUX 1 TO AUX 2 TO LR

SUBGROUPS 1 2 3 4

SOLO LEFT RIGHT

TALKBACK LEVEL PUSH TO TALK AUX 1-4 MAIN

Dimensions

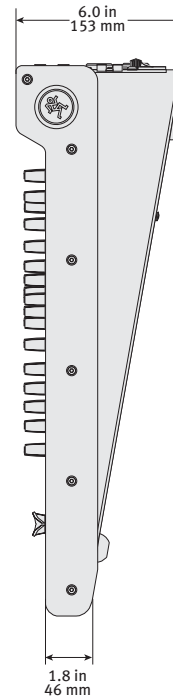
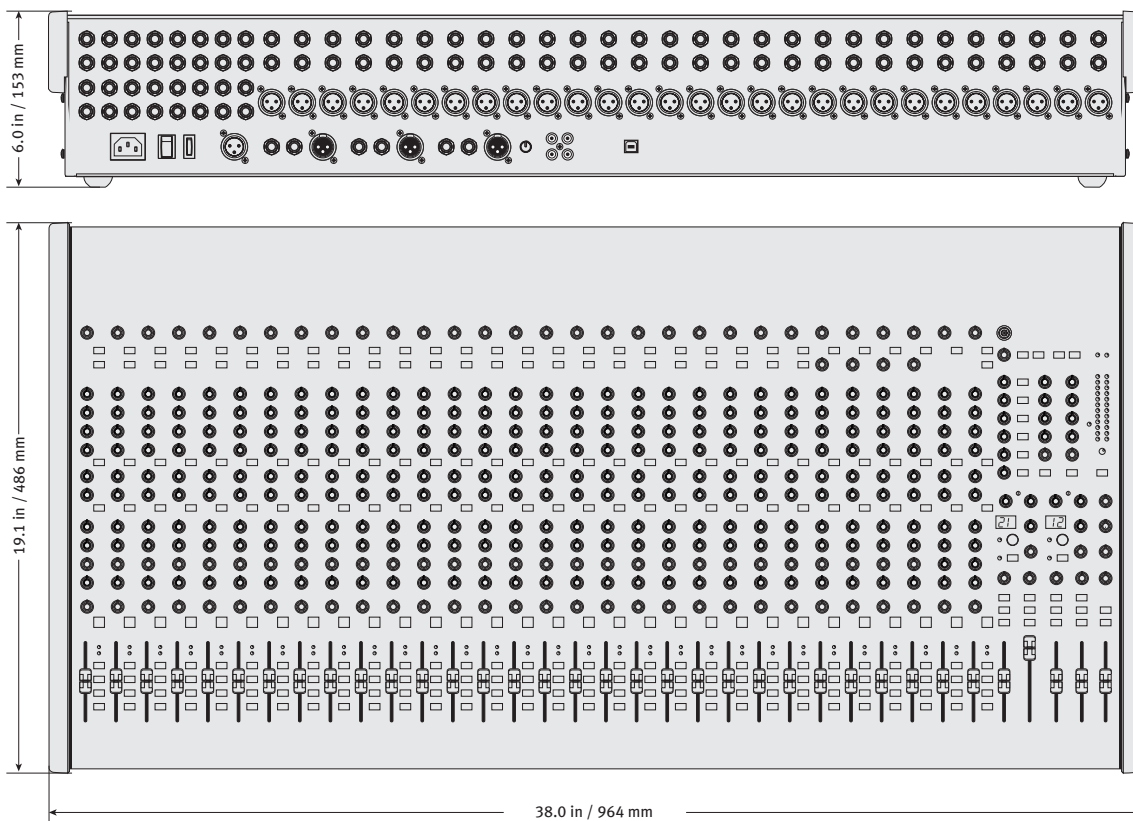
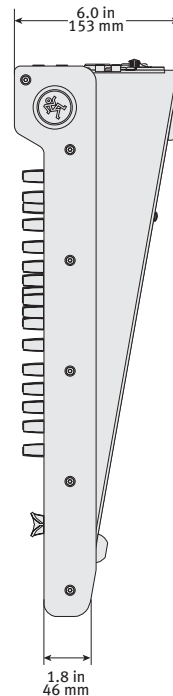
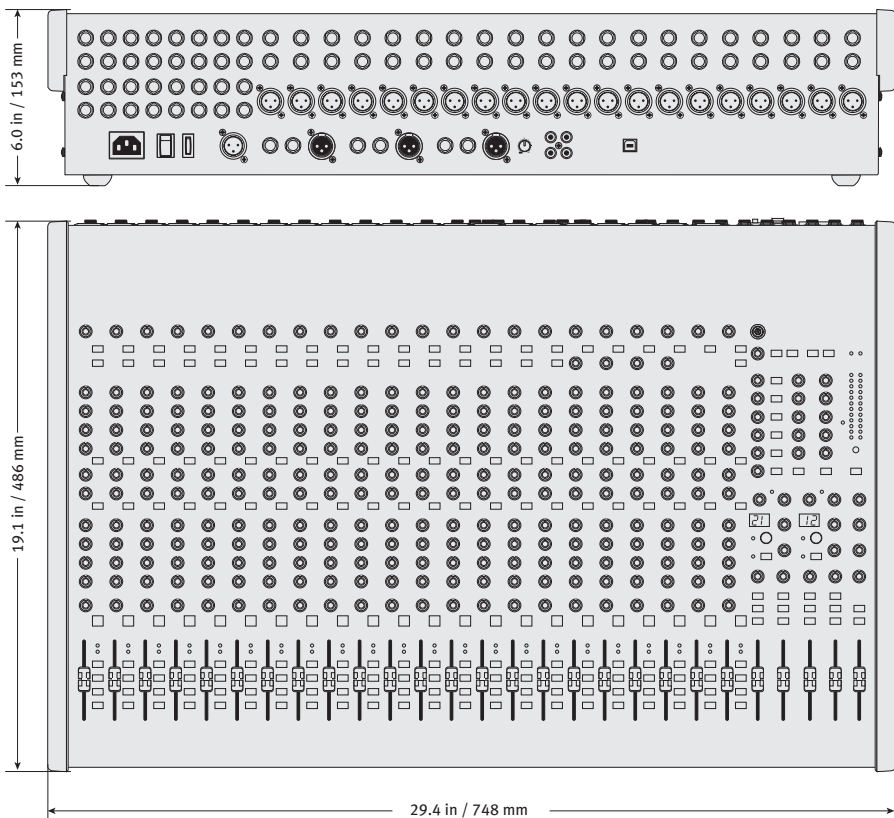

Appendix D: USB

The built-in USB interface allows for some powerful and flexible routing. It is a 4x2 interface allowing you to record up to four streams from the mixer, or to input stereo playback from a computer and route it to nearly any output or pair of outputs on the mixer. To use this feature with a PC, first download the PC ASIO driver from www.720trees.com. If connecting to a Mac, the mixer will show up as a 4x2 device with no driver required.

The USB routing capabilities are as follows:

USB input TO the mixer - playback:

(1) Stereo channel 23/24 (on the 2404VLZ4) and 31/32 (on the 3204VLZ4) features a USB button, so one may route computer output (such as iTunes®) down the last stereo channel of the board. This stereo signal may then be EQ'd, sent to auxiliaries (i.e. to feed monitors, headphones or effects) and is routable to mains and/or subgroups via the fader routing features that are available on all other channels. In short, this signal may be sent to nearly any desired output or pair of outputs. Additionally, the gain knob at the top of this channel strip adjusts the USB input level to the mixer to achieve an optimal signal level.

(2) The 2-Track Return section features a “flip” switch, so a “Tape” source (connected via RCA cables, such as an iPod®) or the USB signal from a computer (playing Windows Media Player® files, for example) may be routed to the main bus. This section also features a solo button and input level adjustment for fading house music up and down between bands, at a house of worship, or any other event where this may be necessary.

USB output FROM the mixer - recording, etc:

(1) A variety of different signals may be recorded via the USB output section, depending on the setup. In the 'USB OUT' section, the switch on the left [51] will select either Groups 1-2 or the main mix to feed USB output channels 1-2. The second switch (to the right) will select either Groups 3-4 or Aux 5-6 to feed USB output channels 3-4.

For example, with both USB output switches in the default position (up), true 4-track recording may be accomplished via routing to subgroups 1-4. The USB tap points for the subgroups are pre-fader (also pre-insert) and post-compressor. The signals will show up on the DAW dependent upon how they are panned on the channels.

In other words, if subgroups 1 and 2 are used to sub-mix drums and those drums have a stereo image (e.g. overheads and toms pan according to desire), this stereo image is retained in the DAW inputs (assuming subgroup 1 is set to “L” and subgroup 2 is set to “R”). Any adjustments made to the subgroup drum levels during the show only pertain to the live show itself; recording levels are not adjusted in the DAW unless they are adjusted on the channels. However, compression settings made on the mixer will apply to the recording.

Likewise, it is possible to record the main mix to take home a copy of the live show. These levels are also pre-main fader. Therefore, levels may be mixed up or down in the DAW later depending on the needs of the recording versus the live show. The end result is that fade-ins and/or fade-outs made during the show do not affect recorded levels.

And finally, it is possible to route the aux 5-6 (again, pre-fader) mixer signals into a DAW or plug-in host. From there, re-route the output of the DAW (or plug-in host) back into the mixer. Voilà...a powerful outboard effects unit!



Success here is partially dependent upon the computer's speed. It needs to be fast enough to run at low buffer sizes so that there is no noticeable latency between the input signal and, say, the reverb return. This kind of flexible routing allows for a variety of choices: running aux 5-6 as effects sends to outboard gear, internal effects sends (native to the board), DAW plug-ins (via USB) or as monitor mix feeds...a truly powerful feature! Be sure to review the software requirements on www.720trees.com to confirm that the latest device drivers are currently in use.

Appendix E: Table of Effects Presets

No.	Title	Description	Example of its use
01	Plate Reverb	This preset emulates vintage mechanical reverberation that was generated with a metal plate. Its sound is characterized by lots of early reflections and no pre-delay.	Perfect for thickening percussive instruments, such as a snare drum, or tight vocal arrangements.
02	Vocal Plate	This vintage plate emulation is warmer than your standard plate, with a long reverberant tail, lots of fast reflections and a very short pre-delay.	Particularly suited for vocal signals, but can also be used for extra-thick drum tracks.
03	Warm Room	This preset is characterized by lots of fast early reflections with a short pre-delay to simulate the sound of a small, wood paneled room.	Useful for adding a tight and controlled ambient effect to vocals and acoustic instruments.
04	Bright Room	This room has a bright tone with lots of scattered reflections to simulate harder, more reflective surfaces.	Useful on vocals that require a brighter reverb to cut through the mix, or for giving acoustic instruments a livelier vibe.
05	Warm Lounge	This preset features a medium sized room sound, with just enough enhancement of the lower mids to produce a warm tone.	Useful for vocals on songs that require a larger, more "wet" sound, or for giving dimension to bright horns without adding harshness.
06	Small Stage	This preset simulates the sound of a small concert stage, with a medium reverb time and reverberant space.	Useful for vocals or guitars in fast paced, high-energy songs that call for a "live" sounding reverberation.
07	Warm Theater	This reverb has a warm bodied tone and medium long reverb time to simulate the live acoustics of a theater space.	Perfect for vocals, drums, acoustic and electric guitars, keyboards, and more.
08	Bright Stage	This preset emulates the sound of a large performance stage, characterized by medium long reverb time and pre-delay, plus a touch of sizzle.	Great for adding life and dimension to drums and other acoustic instruments, and for that big live vocal sound.
09	Warm Hall	This reverb simulates the sound of a spacious, yet cozy, heavily draped and carpeted concert hall with an especially warm tone.	Perfect for adding natural concert hall ambience to close-mic'ed orchestral instruments.
10	Concert Hall	This hall reverb is characterized by its large, spacious sound, long pre-delay, and vibrant tone.	Adds life to acoustic instruments and vocals from solos to full-on symphonies and choirs.
11	Cathedral	This reverb emulates the extremely long tails, dense diffusion and long pre-delays and reflections that would be found in a very large, stone walled house of worship.	Gives amazing depth to choirs, wind instruments, organs, and soft acoustic guitars.
12	Gated Reverb	This preset incorporates an age-old trick whereby an extremely dense reverb is processed through a fast gate for an interesting, albeit artificial, sound.	Most often used to fatten snare drums and toms without clutter.
13	Chorus	This preset provides a soft, ethereal sweeping effect that is useful for thickening and for making a particular sound pop out of the mix.	Perfect for enhancement of electric and acoustic guitar and bass, or to add a dramatic effect to vocals, particularly group harmonies and choirs.
14	Chorus + Reverb	This preset perfectly combines the chorus effect above with a large, roomy reverb.	This lets you both thicken your sound with the chorus effect while adding warmth and spaciousness thanks to the smooth reverb.
15	Doubler	This effect simulates the sound of a vocal or instrument being recorded twice (double tracked) on a multi-track recorder.	Provides a vibe that is similar to chorus without the subtle swirl.
16	Tape Slap	This effect provides a single, relatively rapid delay of the original signal, with the added warmth that vintage tape-based echo units provided.	Often used on vocals for a 1950's era feel, or on guitars for a surf-type tone. Often used by people whose favorite number is 16.
17	DLY 1 Bright (350ms)	These 6 delay presets provide one (delay 1), three (delay 2), or six (delay 3) repeats of the original signal. The default delay time for each preset is shown in mS - the smaller the time, the faster the delay. Delay times can easily be customized to suit the moment by tapping the knob [63] more than once.	These work best with full, up-beat music like rock where the delay needs to cut through the mix. Warm delays get progressively softer and warmer in tone with each repetition and work great with slow, mellow music. Bright delays have repeats that are consistent in tone with the original sound.
18	DLY 1 Warm (300ms)		
19	DLY 2 Bright (250ms)		
20	DLY 2 Warm (200ms)		
21	DLY 3 Bright (175ms)		
22	DLY 3 Warm (150ms)		
23	Chorus + DLY (300ms)	This effect combines the thickening effect of the chorus with the echoes of the 3-repeat delay effect. Delay times can easily be customized to suit the moment by using the Tap feature.	Useful on a clean electric guitar that needs a mildly swirling, ethereal tone.
24	Reverb + DLY (200ms)	This effect combines the Warm Theater reverb effect with the echoes of the 3-repeat delay effect. Delay times can easily be customized to suit the moment by using the Tap feature.	Perfect for thickening vocals while adding dimensions, it can also be used as a spacey effect on electric guitars.

For presets 17 to 24, the delay can be entered by tapping the preset selector knobs [65] more than once.

VLZ4 4•Bus Limited Warranty

Please keep your sales receipt in a safe place.

This Limited Product Warranty (“Product Warranty”) is provided by LOUD Technologies Inc. (“LOUD”) and is applicable to products purchased in the United States or Canada through a LOUD-authorized reseller or dealer. The Product Warranty will not extend to anyone other than the original purchaser of the product (hereinafter, “Customer,” “you” or “your”).

For products purchased outside the U.S. or Canada, please visit www.720trees.com to find contact information for your local distributor, and information on any warranty coverage provided by the distributor in your local market.

LOUD warrants to Customer that the product will be free from defects in materials and workmanship under normal use during the Warranty Period. If the product fails to conform to the warranty then LOUD or its authorized service representative will at its option, either repair or replace any such nonconforming product, provided that Customer gives notice of the noncompliance within the Warranty Period to the Company at: www.720trees.com or by calling LOUD technical support at 1.800.898.3211 (toll-free in the U.S. and Canada) during normal business hours Pacific Time, excluding weekends or LOUD holidays. Please retain the original dated sales receipt as evidence of the date of purchase. You will need it to obtain any warranty service.

For full terms and conditions, as well as the specific duration of the Warranty for this product, please visit www.720trees.com.

The Product Warranty, together with your invoice or receipt, and the terms and conditions located at www.720trees.com constitutes the entire agreement, and supersedes any and all prior agreements between LOUD and Customer related to the subject matter hereof. No amendment, modification or waiver of any of the provisions of this Product Warranty will be valid unless set forth in a written instrument signed by the party to be bound thereby.



16220 Wood-Red Road NE
Woodinville, WA 98072 • USA
Phone: 425.487.4333
Toll-free: 800.898.3211
Fax: 425.487.4337
www.720trees.com
