

1604VLZ4

16-Channel 4-Bus Compact Mixer

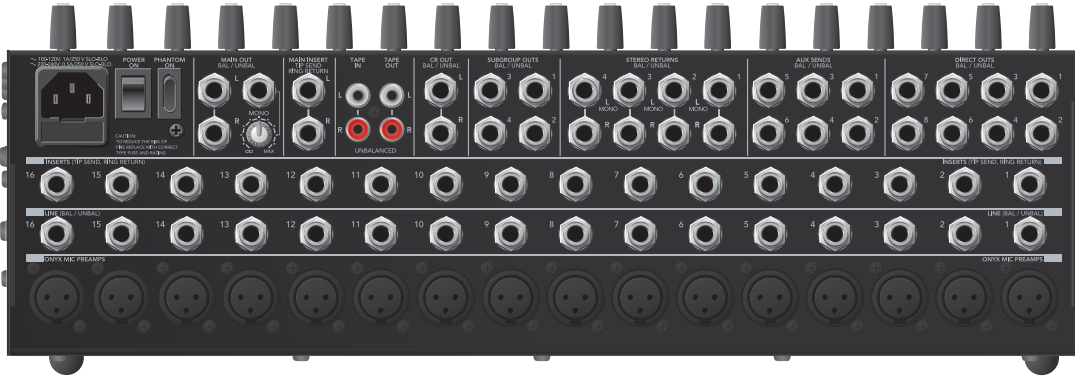

OWNER'S MANUAL



Important Safety Instructions

1. Read these instructions.
2. Keep these instructions.
3. Heed all warnings.
4. Follow all instructions.
5. Do not use this apparatus near water.
6. Clean only with a dry cloth.
7. Do not block any ventilation openings. Install in accordance with the manufacturer's instructions.
8. Do not install near any heat sources such as radiators, heat registers, stoves, or other apparatus (including amplifiers) that produce heat.
9. Do not defeat the safety purpose of the polarized or grounding-type plug. A polarized plug has two blades with one wider than the other. A grounding-type plug has two blades and a third grounding prong. The wide blade or the third prong are provided for your safety. If the provided plug does not fit into your outlet, consult an electrician for replacement of the obsolete outlet.
10. Protect the power cord from being walked on or pinched particularly at plugs, convenience receptacles, and the point where they exit from the apparatus.
11. Only use attachments/accessories specified by the manufacturer.
12. Use only with a cart, stand, tripod, bracket, or table specified by the manufacturer, or sold with the apparatus. When a cart is used, use caution when moving the cart/apparatus combination to avoid injury from tip-over.
13. Unplug this apparatus during lightning storms or when unused for long periods of time.
14. Refer all servicing to qualified service personnel. Servicing is required when the apparatus has been damaged in any way, such as power-supply cord or plug is damaged, liquid has been spilled or objects have fallen into the apparatus, the apparatus has been exposed to rain or moisture, does not operate normally, or has been dropped.
15. This apparatus shall not be exposed to dripping or splashing, and no object filled with liquids, such as vases or beer glasses, shall be placed on the apparatus.
16. Do not overload wall outlets and extension cords as this can result in a risk of fire or electric shock.
17. This apparatus has been designed with Class-I construction and must be connected to a mains socket outlet with a protective earthing connection (the third grounding prong).
18. This apparatus has been equipped with a rocker-style AC mains power switch. This switch is located on the rear panel and should remain readily accessible to the user.
19. The MAINS plug or an appliance coupler is used as the disconnect device, so the disconnect device shall remain readily operable.



	CAUTION AVIS RISK OF ELECTRIC SHOCK. DO NOT OPEN RISQUE DE CHOC ELECTRIQUE. NE PAS OUVRIR	
<p>CAUTION: TO REDUCE THE RISK OF ELECTRIC SHOCK DO NOT REMOVE COVER (OR BACK) NO USER-SERVICEABLE PARTS INSIDE. REFER SERVICING TO QUALIFIED PERSONNEL</p> <p>ATTENTION: POUR EVITER LES RISQUES DE CHOC ELECTRIQUE, NE PAS ENLEVER LE COUVERCLE. AUCUN ENTRETIEN DE PIECES INTERIEURES PAR L'USAGER. CONFIER L'ENTRETIEN AU PERSONNEL QUALIFIE.</p> <p>AVIS: POUR EVITER LES RISQUES D'INCENDIE OU D'ELECTROCUTION, N'EXPOSEZ PAS CET ARTICLE A LA PLUIE OU A L'HUMIDITE</p>		



The lightning flash with arrowhead symbol within an equilateral triangle is intended to alert the user to the presence of uninsulated "dangerous voltage" within the product's enclosure, that may be of sufficient magnitude to constitute a risk of electric shock to persons.

Le symbole éclair avec point de flèche à l'intérieur d'un triangle équilatéral est utilisé pour alerter l'utilisateur de la présence à l'intérieur du coffret de "voltage dangereux" non isolé d'ampleur suffisante pour constituer un risque d'électrocution.



The exclamation point within an equilateral triangle is intended to alert the user of the presence of important operating and maintenance (servicing) instructions in the literature accompanying the appliance.

Le point d'exclamation à l'intérieur d'un triangle équilatéral est employé pour alerter les utilisateurs de la présence d'instructions importantes pour le fonctionnement et l'entretien (service) dans le livret d'instruction accompagnant l'appareil.

20. NOTE: This equipment has been tested and found to comply with the limits for a Class B digital device, pursuant to part 15 of the FCC Rules. These limits are designed to provide reasonable protection against harmful interference in a residential installation. This equipment generates, uses, and can radiate radio frequency energy and, if not installed and used in accordance with the instructions, may cause harmful interference to radio communications. However, there is no guarantee that interference will not occur in a particular installation. If this equipment does cause harmful interference to radio or television reception, which can be determined by turning the equipment off and on, the user is encouraged to try to correct the interference by one or more of the following measures:
 - Reorient or relocate the receiving antenna.
 - Increase the separation between the equipment and the receiver.
 - Connect the equipment into an outlet on a circuit different from that to which the receiver is connected.
 - Consult the dealer or an experienced radio/TV technician for help.

- CAUTION: Changes or modifications to this device not expressly approved by LOUD Technologies Inc. could void the user's authority to operate the equipment under FCC rules.
21. This apparatus does not exceed the Class A/Class B (whichever is applicable) limits for radio noise emissions from digital apparatus as set out in the radio interference regulations of the Canadian Department of Communications.

ATTENTION — *Le présent appareil numérique n'émet pas de bruits radioélectriques dépassant les limites applicables aux appareils numériques de class A/de class B (selon le cas) prescrites dans le règlement sur le brouillage radioélectrique édicté par les ministere des communications du Canada.*

22. Exposure to extremely high noise levels may cause permanent hearing loss. Individuals vary considerably in susceptibility to noise-induced hearing loss, but nearly everyone will lose some hearing if exposed to sufficiently intense noise for a period of time. The U.S. Government's Occupational Safety and Health Administration (OSHA) has specified the permissible noise level exposures shown in the following chart. According to OSHA, any exposure in excess of these permissible limits could result in some hearing loss. To ensure against potentially dangerous exposure to high sound pressure levels, it is recommended that all persons exposed to equipment capable of producing high sound pressure levels use hearing protectors while the equipment is in operation. Ear plugs or protectors in the ear canals or over the ears must be worn when operating the equipment in order to prevent permanent hearing loss if exposure is in excess of the limits set forth here:

Duration, per day in hours	Sound Level dBA, Slow Response	Typical Example
8	90	Duo in small club
6	92	
4	95	Subway Train
3	97	
2	100	Very loud classical music
1.5	102	
1	105	Matt screaming at Troy about deadlines
0.5	110	
0.25 or less	115	Loudest parts at a rock concert

WARNING — To reduce the risk of fire or electric shock, do not expose this apparatus to rain or moisture.



Correct disposal of this product. This symbol indicates that this product should not be disposed of with your household waste, according to the WEEE Directive (2002/96/EC) and your national law. This product should be handed over to an authorized collection site for recycling waste electrical and electronic equipment (WEEE). Improper handling of this type of waste could have a possible negative impact on the environment and human health due to potentially hazardous substances that are generally associated with WEEE. At the same time, your cooperation in the correct disposal of this product will contribute to the effective usage of natural resources. For more information about where you can drop off your waste equipment for recycling, please contact your local city office, waste authority, or your household waste disposal service.

Contents

IMPORTANT SAFETY INSTRUCTIONS	2
CONTENTS	3
FEATURES / INTRODUCTION	4
GETTING STARTED	5
HOOKUP DIAGRAMS	6
CONVERTING TO RACKMOUNT MODE	8
PATCHBAY DESCRIPTION	9
EZ INTERFACE	9
1. MIC INS	9
PHANTOM POWER	9
2. LINE INS	10
3. GAIN	10
4. INSERT	10
5. DIRECT OUT	10
SPLIT MONITORING	10
6. AUX SENDS	11
EFFECTS: SERIAL OR PARALLEL?	11
7. STEREO RETURNS	12
8. SUB OUTS	12
DOUBLE BUSING	12
9. CR OUTS (CONTROL ROOM OUTPUTS)	12
10. PHONES OUT (ON FRONT PANEL)	12
11. TAPE OUT	12
12. TAPE IN	13
13. MAIN INSERT	13
14. MAIN OUTS	13
15. MONO OUT	13
16. MONO LEVEL	13
17. VOLTAGE SELECTOR	13
18. POWER CONNECTION	13
19. FUSE	14
20. POWER SWITCH	14
21. POWER LED	14
22. PHANTOM SWITCH	14
23. 48V LED	14
24. BNC LAMP SOCKET	14
CHANNEL STRIP DESCRIPTION	15
"U" LIKE UNITY GAIN	15

Please write your serial number here for future reference (i.e., insurance claims, tech support, return authorization, make dad proud, etc.)

Purchased at:

Date of purchase:

25. CHANNEL FADER	15
A CLEAN FADE	15
26. ASSIGN (1-2, 3-4, L-R)	15
27. SOLO	16
28. -20 (SOLO) LED	16
29. OL (MUTE) LED	16
30. MUTE	16
31. PAN	17
STEREO SOURCES	17
CONSTANT LOUDNESS !!!	17
32. 3-BAND MID-SWEEP EQ	17
33. LOW CUT	18
34. AUX 1, 2, 3, & 4	18
35. PRE	18
36. 5/6 SHIFT	18

OUTPUT SECTION DESCRIPTION	19
37. MAIN MIX FADER	19
38. SUBGROUP FADERS	19
39. ASSIGN TO MAIN MIX	19
40. TAPE IN (LEVEL)	20
41. TAPE TO MAIN MIX	20
42. SOURCE	20
43. CR/PHONES	20
44. MODE (AFL/PFL)	21
45. LEVEL SET LED	21
46. SOLO (LEVEL)	21
47. RUDE SOLO LIGHT	21
48. METERS	22
METERS VS. REALITY	22
AUX TALK	23
49. AUX SENDS (MASTER)	23
50. AUX SENDS SOLO	23
51. STEREO RETURNS (LEVEL)	23
52. TO AUX 1 AND TO AUX 2	24
53. MAIN MIX TO SUBS (STEREO RET 3)	24
54. 1-2/3-4 (STEREO RETURN 3)	24
55. CR/PH ONLY (STEREO RETURN 4)	25
56. RETURNS SOLO AND LED	25

APPENDIX A: SERVICE INFORMATION	26
APPENDIX B: CONNECTIONS	26
APPENDIX C: TECHNICAL INFORMATION	30
DIMENSIONS	31
TRACK SHEET	32
BLOCK DIAGRAM	34
1604VLZ4 LIMITED WARRANTY	35



Like us



Follow us



Watch our dang videos

Features

- 16-channel mixer featuring our signature high-headroom, low-noise design
- 16 boutique-quality Onyx mic preamps
 - Ultra-wide 60 dB gain range
 - 128.5 dB dynamic range
 - +22 dBu line input handling
 - Extended frequency response
 - Distortion under 0.0007% (20 Hz - 50 kHz)
- Improved RF rejection, perfect for broadcast applications
- Phantom power for condenser mics
- 16 high-headroom line inputs with +4/-10 operation control
- 16 balanced inserts perfect for integrating outboard gear
- 3-band EQ with sweepable midrange
- 18 dB/oct 75 Hz low-cut filter on mic input channels
- Four aux sends, level, pan and solo and overload/mute LEDs on each channel
- Four stereo returns, eight direct outs and four group/bus outputs
- 60 mm long-wearing log-taper faders
- Control room / phones multi-input source matrix
- High-resolution 12-segment stereo meters
- Sealed rotary control resist dust and grime
- “Built-Like-A-Tank” rugged steel chassis with powder-coat finish
- High-visibility, high-contrast controls deliver convenient “at-a-glance” visual feedback
- Rack-mountable design with three physical configurations via Rotopod accessory (sold separately)
- Multi-voltage power supply for worldwide use

Introduction

A legend in compact mixer design, the 1604VLZ4 now combines the proven performance of Onyx preamps with the no-compromise high-headroom/low-noise design that made the 1604 an industry mainstay.

All 16 channels feature an Onyx mic pre, line input and insert in a compact 4-bus design built for application flexibility and professional performance. Plus, it is truly “Built-Like-A-Tank” with a ridiculously rugged solid-steel chassis that includes high-contrast controls for ultimate tactile control.

Found in countless professional broadcast and post facilities and easily the most proven band-friendly analog mixer ever, the 1604 stands alone in the world of compact mixing.

How To Use This Manual

After the introduction, a getting started guide will help you get things set up fast. These are followed by hookup diagrams which show some typical setups.

Next is a detailed tour of the entire mixer. The descriptions are divided into sections, just as your mixer is organized into distinct zones:

- Patchbay
- Channel Strip
- Output Section

Throughout these sections you’ll find illustrations with each feature numbered and described in nearby paragraphs.



This icon marks information that is critically important or unique to the mixer. For your own good, read them and remember them.



This icon will lead you to some explanations of features and practical tips. They usually have some valuable nuggets of information.

Need help with your mixer?

- Visit www.720trees.com and click Support to find: FAQs, manuals and other useful information.
- Email us at: techmail@loudtechinc.com.
- Telephone 1-800-898-3211 to speak with one of our splendid technical support chaps (Monday through Friday, normal business hours, Pacific Time).

Getting Started

We realize that you must be really keen to try out the mixer. Please read the safety instructions on page 2, then have a look through some of the features and details in this manual.

Setup

Use the mixer in a nice clean and dry environment, free from dryer lint and dust bunnies.

Zero the controls

1. Fully turn down all the knobs and faders to minimum, except for the channel EQ and pan controls, which should be centered.
2. Make sure all buttons are in the out position.

Connections

1. Make sure the AC power switch is off before making any connections.



WARNING: Before plugging the AC power cord into the mixer, make sure the VOLTAGE SELECTOR switch is set to the same voltage as the local AC mains supply (see page 13).

2. Push the linecord securely into the IEC connector on the rear panel, and plug it into a 3-prong AC outlet. The mixer may accept any AC voltage ranging from 100 VAC to 240 VAC.
3. Plug a balanced microphone into one of the mic XLR (3-pin) connectors. Or connect any line-level signal (keyboard, or guitar preamp) to a line input jack using a TS or a TRS 1/4" plug.
4. If your microphone requires phantom power, turn on the 48V phantom power button.
5. All 16 channels have insert jacks that can be used to connect an external effects or dynamics processor into the signal chain.
6. Connect the TRS 1/4" main outputs of the mixer to the line level inputs of your amplifier (with speakers already attached) or to the line level inputs of powered speakers.

Set the levels

It's not even necessary to hear what you're doing to set optimal levels. But if you'd like to: Plug headphones into the phones output jack, then turn up the CR/phones knob just a little.

1. Turn on the mixer by pressing the top edge of the power switch.
2. For one channel, press the solo switch in.
3. Engage the mode switch in the master section. A green level set light will turn on.
4. Play something into that input at real-world levels.
5. Adjust that channel's gain control until the left main meter stays around the 0 dB LED (marked "level set") and never goes higher than "+7."
6. Disengage the channel's solo switch.
7. Repeat steps 2 to 6 for the remaining channels.
8. Turn up the channel fader to the "U" mark.
9. Slowly turn up the main mix fader until you hear the signals in the headphones.
10. If needed, apply some channel EQ wisely.
11. Adjust the channel faders to get the best mix. Keep the gain controls and levels fully down on unused channels.
12. During the performance, if you notice a channel OL LED turning on during peaks, carefully turn down that channel's gain control until OL does not turn on.

Things to Remember

- Never listen to loud music for prolonged periods. Please see the Safety Instructions on page 2 for information on hearing protection.
- Always turn down the main mix fader and control room/phones knob down when making connections to the mixer. Better yet, turn off the power.
- When shutting down, turn off any power amplifiers or powered speakers first. When powering up, turn them on last. This will reduce the chance of turn-on or turn-off thumps.
- Save the shipping box!

Hookup Diagrams

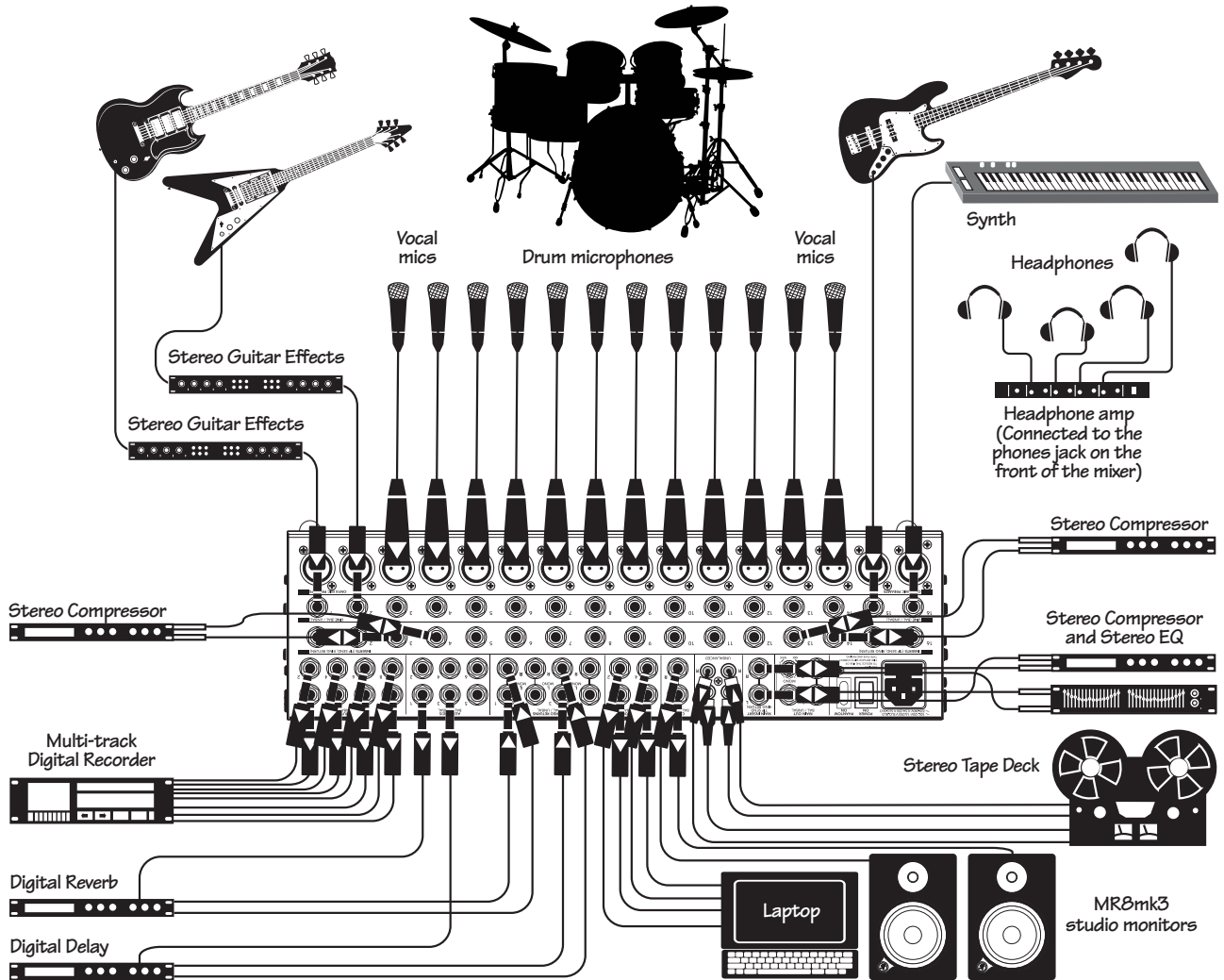

The rhythm and lead guitars play through stereo effects processors plugged into the line inputs of channels 1 and 2. Microphones are connected to the mic inputs of channels 3-14 with vocal compressors connected to the channel 3-4 and 13-14 insert jacks. [Drums are mic'd on channels 5-12]. A bass guitar is connected to the line input of channel 15, while a synth is connected to the line input of channel 16.

A stereo compressor and stereo graphic EQ are connected to the L/R main inserts. Digital reverb and delay processors are connected to aux sends 1 and 3, with the aux sends set to post-level. Effects are added to the main mix via the stereo return inputs, and adjusted with the stereo return level control.

There are a multitude of recording possibilities geared for both analog purists and digital hounds. There are three examples listed here, but feel free to experiment! (1) the RCA tape inputs and outputs are connected to a stereo tape deck. It's an easy way to get a stereo recording of the entire band, as well as listening to playback (over tape), (2) the eight direct outputs are connected to the eight inputs of a multi-track digital recorder, and (3) the four subgroup outs are connected to the laptop. Again, there are many choices for recording. Do what works for you and your setup!

A pair of MR8mk3 studio monitors are connected to the control room outputs to listen to playback of your latest masterpiece.

Recording System

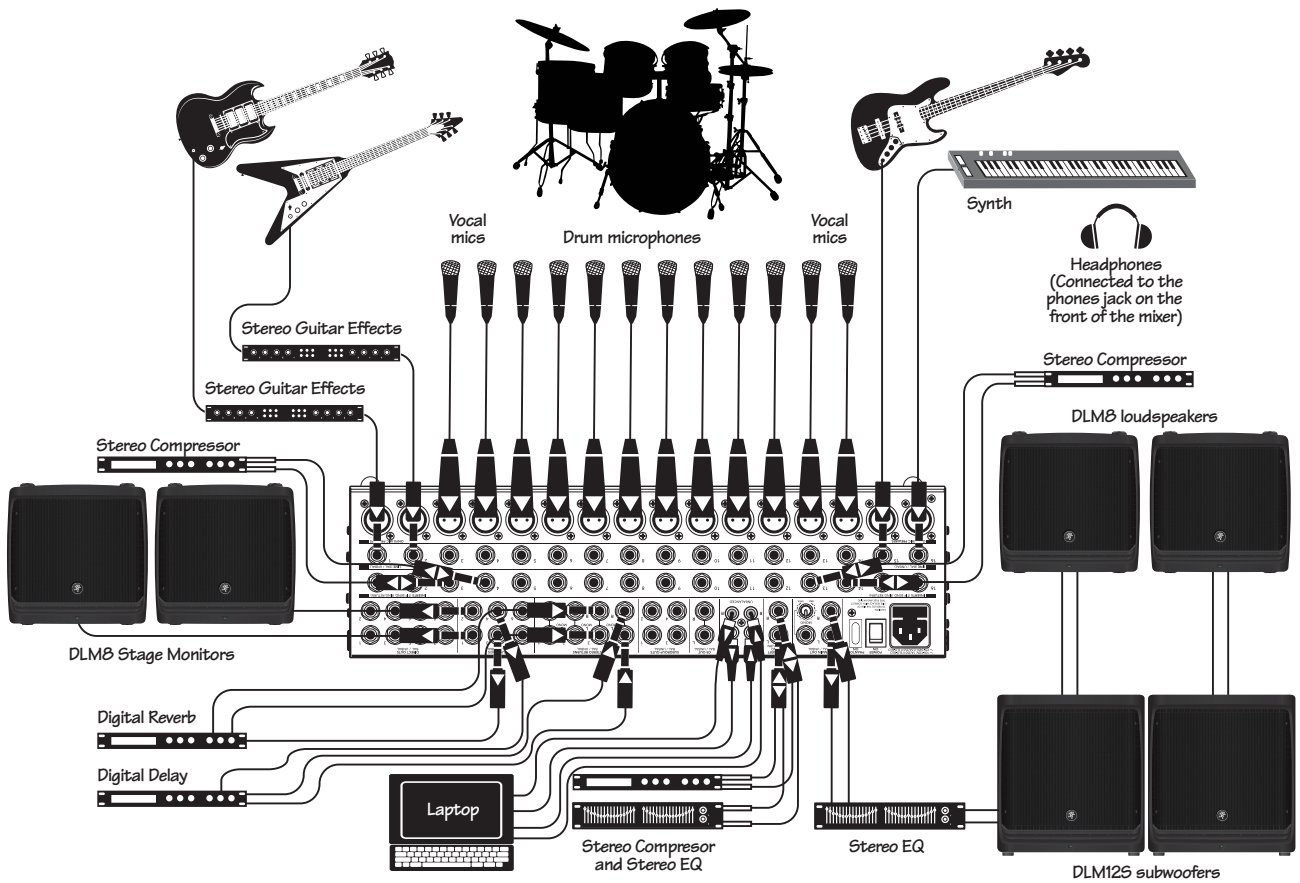

The rhythm and lead guitars play through stereo effects processors plugged into the line inputs of channels 1 and 2. Microphones are connected to the mic inputs of channels 3-14 with vocal compressors connected to the channel 3-4 and 13-14 insert jacks. [Drums are mic'd on channels 5-12]. A bass guitar is connected to the line input of channel 15, while a synth is connected to the line input of channel 16.

A stereo compressor and stereo graphic EQ are connected to the L/R main inserts. The 1/4" L/R main outs connect to a stereo graphic EQ before connecting to a pair of DLM12S powered subwoofers which are connected to a pair of DLM8 powered loudspeakers to please your audience.

Aux sends 1 and 2 are connected to DLM8 powered loudspeakers, used as stage monitors to please the band. Digital reverb and delay processors are connected to aux sends 3 and 4, with the aux sends set to post-level. Effects are added to the main mix via the stereo return inputs, and adjusted with the stereo return level control.

The RCA tape inputs and outputs are connected to a laptop. It's an easy way to get a stereo recording of the live show for posterity and crank your featured playlist over the PA between bands.

Live Stereo PA System

Converting To Rackmount Mode

Not only is the 1604VLZ4 a compact, professional-quality tabletop mixer...it's rack-mountable! The unique rotating input pod makes this possible.

With a trusty phillips screwdriver, nerves of steel, grit, determination, charming good looks and a few moments of your valuable time, it may be converted from desktop mode (from the factory) to rackmount mode:

1. Turn off the power and remove ALL the cords from the mixer — power cord, audio, lamps, everything.
2. Place the mixer, face down, on a clean soft surface, like a blanket or very large dog.
3. Remove the four screws securing the cable cover [a] and set the plate aside.
4. Replace two of the screws; the ones at the pod end of the mixer [b].
5. Remove two pod-mounting screws on each side of the mixer [c].
6. Gently pull the pod away from the slots, rotate it, and place it, tabs first, into the rackmount tabs [d], located on the underside of the main chassis. Be careful not to constrict or pinch any of the ribbon or power cables.

7. Carefully install the pod-mounting screws in their new locations [d].
8. Install the rack ears that came with the mixer, using the supplied packet of screws. These screws are a bit longer than the ones you have to take out. The rack ears may be installed in either of two depths as shown at the bottom of this page: [e] mixer's surface flush with the rack rails, like ordinary rackmount equipment, or [f] mixer's surface sunken into the rack, to protect the knobs from being bumped.

NOTE: If you remove the rack ears at a later date, use the original (shorter) screws to secure the sides.

An optional accessory called the Rotopod-VLZ is available and may be used in desktop or rackmount installations. It will put the patchbay jacks on the same plane as all the knobs, buttons and faders. This is a lifesaver in applications that demand frequent repatching, and costs a heck of a lot less than an external patchbay, not to mention all the interface and patch cords. Please visit your dealer for more exciting details. Be sure to order the "VLZ4" version so you don't end up with the one for the classic CR-1604!

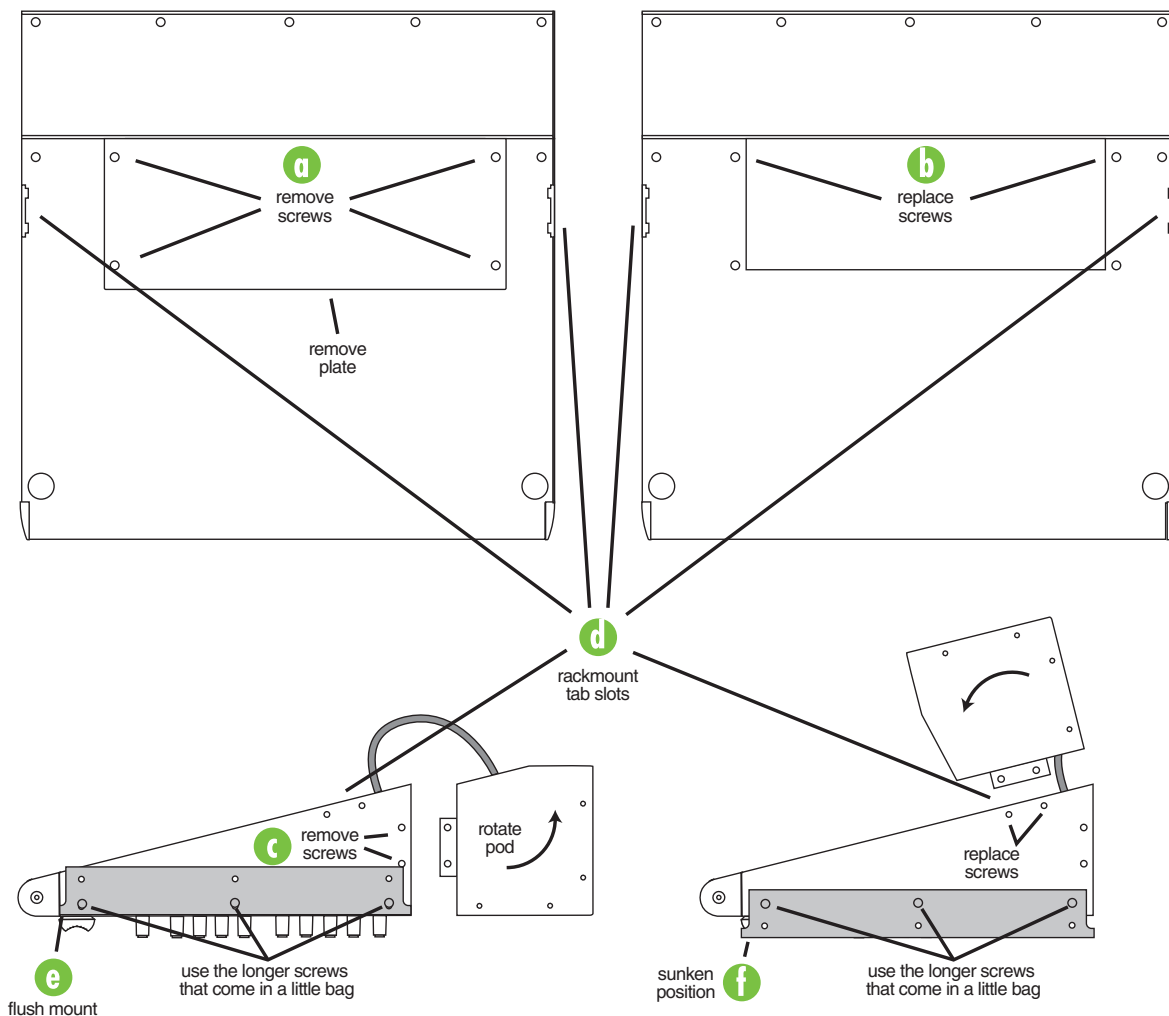

Patchbay Description

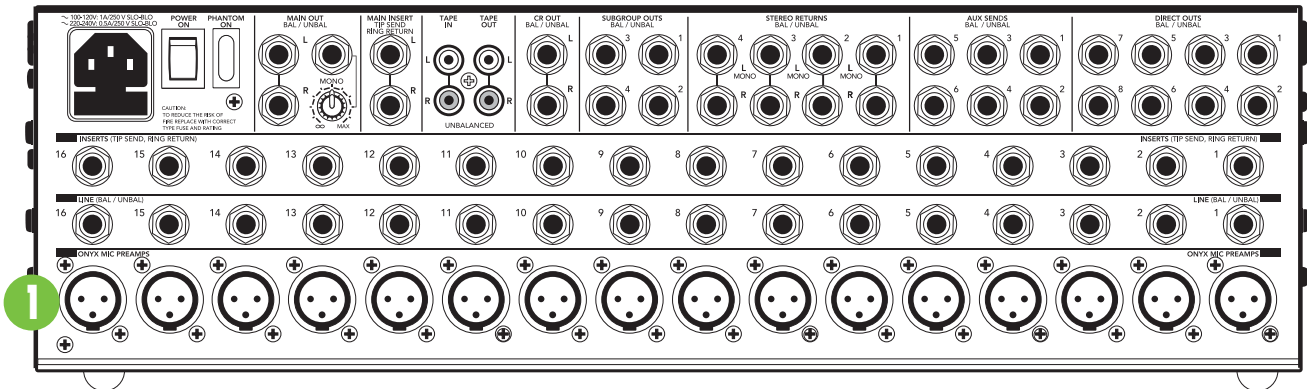

At the risk of stating the obvious, this is where you plug everything in: microphones, line-level instruments and effects, headphones, and the ultimate destination for your sound: PA system, DAW, etc. A few of the features described in this section are on top of the mixer, but most are out back on this “pod.”

See Appendix B (page 27) for further details and some rather lovely drawings of the connectors you can use with the 1604VLZ4.

EZ Interface

Concerned about levels, balancing, impedances, polarity, or other interface goblins? You can patch anything almost anywhere on the 1604VLZ4, with nary a care. Here’s why:

- Every input and output is balanced (except insert, phones and RCA jacks).
- Every input and output will also accept unbalanced lines (except XLR jacks when phantom power is on).
- Every input is designed to accept virtually any output impedance.
- The main left and right mix outputs can deliver 28 dBu into as low as a 600 ohm load.
- All the other outputs can deliver 22 dBu into as low as a 600 ohm load.
- All the outputs are in phase with the inputs.

All we ask is that you perform the level setting procedure [page 5] every time you patch in a new sound source. So stop worrying and start mixing!

1. Mic Ins

This is a female XLR connector that accepts a balanced mic or line level input from almost any type of source. These Onyx mic preamps feature higher fidelity and headroom rivaling any standalone mic preamp on the market today. These circuits are excellent at rejecting hum and noise.

The XLR inputs are wired as follows:

- Pin 1 = Shield or ground
- Pin 2 = Positive (+ or hot)
- Pin 3 = Negative (– or cold)

Professional ribbon, dynamic, and condenser mics all sound excellent through these inputs. The mic/line inputs will handle any kind of level you can toss at them, without overloading.

Not every instrument is made to connect directly to a mixer. Guitars commonly need a Direct Injection (DI) box to connect to the mixer's mic inputs. These boxes convert unbalanced line-level signals from your guitar, into balanced mic-level outputs, and provide signal and impedance matching. They also let you send your gifted guitar renditions over long cables or audio snakes, with minimum interference or high-frequency signal loss. Ask your dealer or guitar maker about their recommendations for a good DI box.

Phantom Power

Most modern professional condenser mics are equipped for phantom power, which lets the mixer send low-current DC voltage to the mic’s electronics through the same wires that carry audio. (Semi-pro condenser mics often have batteries to accomplish the same thing.) “Phantom” owes its name to an ability to be “unseen” by dynamic mics (Shure SM57/SM58, for instance), which don’t need external power and aren’t affected by it anyway.

The 1604VLZ4’s phantom power is globally controlled by the phantom [22] switch on the rear panel. (This means the phantom power for all channels is turned on and off together.)



Never plug single-ended (unbalanced) microphones, or ribbon mics into the mic input jacks if the phantom power is on.



Do not plug instrument outputs into the mic input jacks with phantom power on unless you know for certain it is safe to do so.

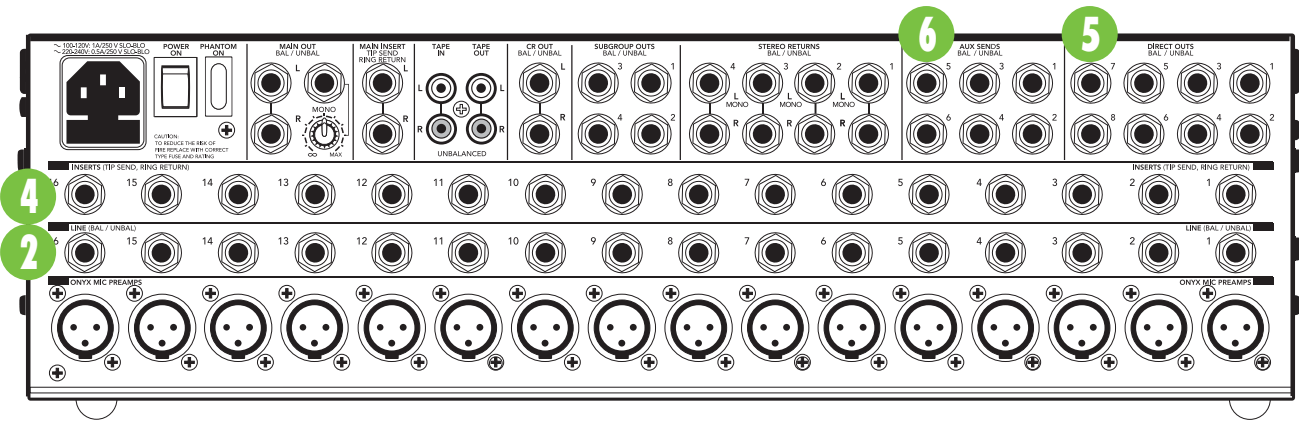

2. Line Ins

These 1/4" jacks share circuitry (but not phantom power) with the mic preamps, and can be driven by balanced or unbalanced sources at almost any level. You can use these inputs for virtually any signal you'll come across, from instrument levels as low as -50 dBu, to operating levels of -10 dBV to $+4$ dBu, since there is -15 to $+45$ dB of gain (60 dB range) available for line inputs via the gain [3] knob. Always make sure to perform the level setting procedure on page 5.

To connect balanced lines to these inputs, use a 1/4" Tip-Ring-Sleeve (TRS) plug, wired as follows:

- Tip = Positive (+ or hot)
- Ring = Negative (- or cold)
- Sleeve = Shield or ground

To connect unbalanced lines to these inputs, use a 1/4" mono (TS) phone plug, wired as follows:

- Tip = Positive (+ or hot)
- Sleeve = Shield or ground

4. Insert

These unbalanced 1/4" jacks are for connecting serial effects processors such as compressors, equalizers, de-essers, or filters. The insert point is after the gain [3] control, but before the channel's EQ [32], low cut [33], fader [25] and mute [30] controls. Insert cables must be wired thusly:

- Tip = send (output to effects device)
- Ring = return (input from effects device)
- Sleeve = common ground

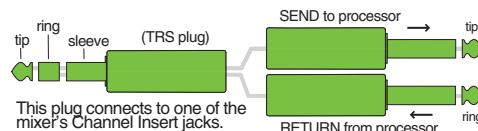

Even though channels 1–8 already have direct out [5] jacks, insert jacks can also be used as channel direct outputs; post-gain, pre-low cut, and pre-EQ. See the connector section on page 29 showing three ways to use insert cables.

5. Direct Out

Found only on channels 1–8, these balanced 1/4" jacks deliver the signal from the very end of the channel path; post-gain [3], post-EQ [32], post-low cut [33], post-fader [25], and post-mute [30]. They are the key player in "split monitoring," making the 1604VLZ4 perfect for an 8-track studio.

Split Monitoring



With split monitoring, you use the first eight channels for your sound sources: vocal mics, drum mics, keyboard/synth outputs, guitar effects outputs, that sort of thing. From there, the channels manipulate the sound, but are not assigned to the output section. Instead, they're patched from the channel's direct out [5] jacks to the corresponding multitrack input (direct out 1 to multitrack input 1, 2 to 2, 3 to 3, etc.). The signals will now be recorded or pass directly through the multitrack, depending on each track's record-ready status.

3. Gain

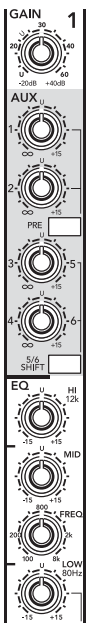

Yes it's true, these controls are not in the patchbay section at all. They're found along the top row of knobs in the channel strip section. But their purpose is so closely linked with the mic and line input jacks that we couldn't bear to separate them. If you haven't already, please read the level-setting procedure on page 5.

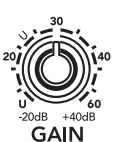

Gain adjusts the input sensitivity of the mic and line inputs. This allows signals from the outside world to be adjusted to optimal internal operating levels.

If the signal originates through the XLR jack, there will be 0 dB of gain with the knob fully down, ramping to 60 dB of gain fully up.

Through the 1/4" input, there is 20 dB of attenuation fully down and 40 dB of gain fully up, with a "U" (unity gain) mark at 10:00. This 20 dB of attenuation can be very handy when you are inserting a very hot signal, or when you want to add a lot of EQ gain, or both. Without this "virtual pad," this scenario might lead to channel clipping.

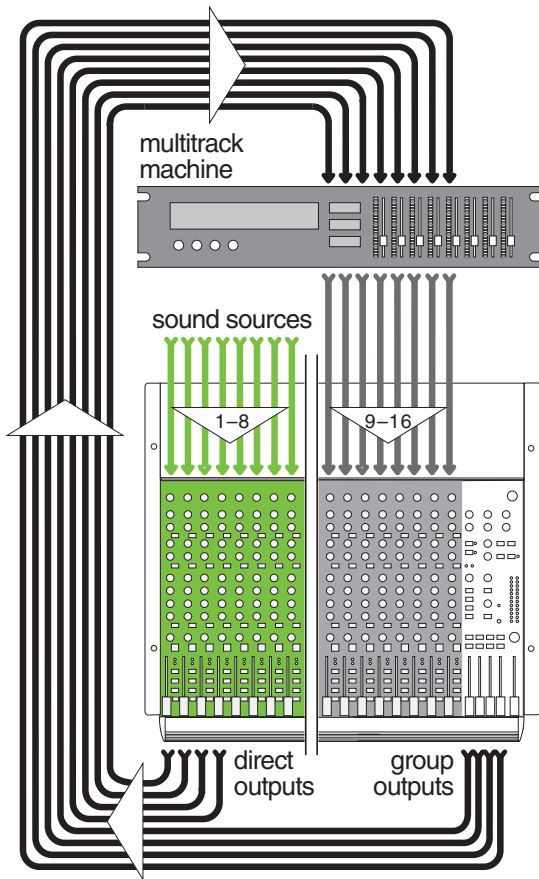

The outputs of the multitrack are then patched to the next eight line [2] inputs on the 1604VLZ4 (multitrack out 1 to line input 9, 2 to 10, 3 to 11, etc.). These channels (9–16) will be assigned to the mixer’s output section, delivering the signals to their ultimate destination, which may be your mixdown 2-track, your control room system, or your headphones.

But let’s not forget that the 1604VLZ4 is a 4-bus mixer. These buses lead to the sub outs [8], and are designed to accomplish the task of getting channels to the multitrack without using the direct outputs.

For example, a channel is assigned to sub out 1. Sub out 1’s output is patched to multitrack input 1. From there, the multitrack output goes to the mixer’s channel 9 line input, as we just discussed. (Hot tip: To feed an 8-track deck with 4 sub outputs, simply use Y-cords: sub out 1 feeds tracks 1 and 5, 2 feeds 2 and 6, 3 feeds 3 and 7, and 4 feeds 4 and 8. Tracks in record mode will accept the signal, and tracks in safe mode will ignore the signal.)

The advantages: You can assign any channel to any track, without repatching. You can assign multiple channels to one track and control the overall level of that subgroup. You can’t bounce tracks without this feature.

Perhaps the best method is to do both: Use the sub outs to feed multichannel submixes (like a drum kit) to some of the tracks, and the direct out jacks to feed single-channel signals (like bass guitar) to the other tracks.

The point is that you never listen directly to the source channels (1–8). You listen to the monitor channels (9–16) and they’re listening to the multitrack that is listening to the source channels. (Make sure to assign the monitor channels 9-16 to the L/R mix, and not the source channels 1-8.) The main advantage is that you won’t be forced to constantly repatch your multitrack — just set it up and forget it. You’ll also know for certain that the signals are indeed getting to the multitrack, since you’re constantly listening to it.

Another method of interfacing a multitrack is called inline monitoring, and requires a dedicated mixing console. Each of its channels is actually two channels: one carrying the mic/line sound source and the other carrying the multitrack output.

6. Aux Sends

These 1/4" jacks usually patch to the inputs of a parallel effects devices or to the inputs of stage monitor amps. For details see “Aux Talk” on page 23.

Effects: Serial Or Parallel?

You’ve heard us carelessly toss around the terms “serial” and “parallel.” Here’s what we mean by them:

“Serial” means that the entire signal leaves the mixer [insert (4) send], is routed through the effects device, and returns to the mixer [insert return]. Examples: compressor/limiters, graphic equalizers.

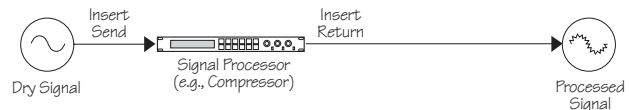

“Parallel” means that a portion of the signal in the mixer is tapped off to the device (aux send), processed and returned to the mixer (stereo return) to be mixed with the original “dry” signal. This way, multiple channels can all make use of the same effects device. Examples: reverb, digital delay.

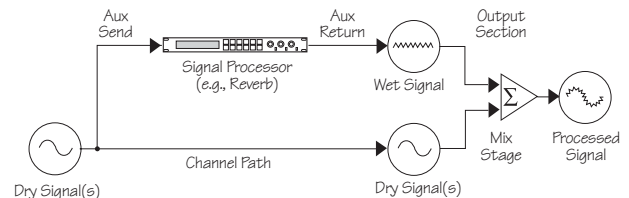

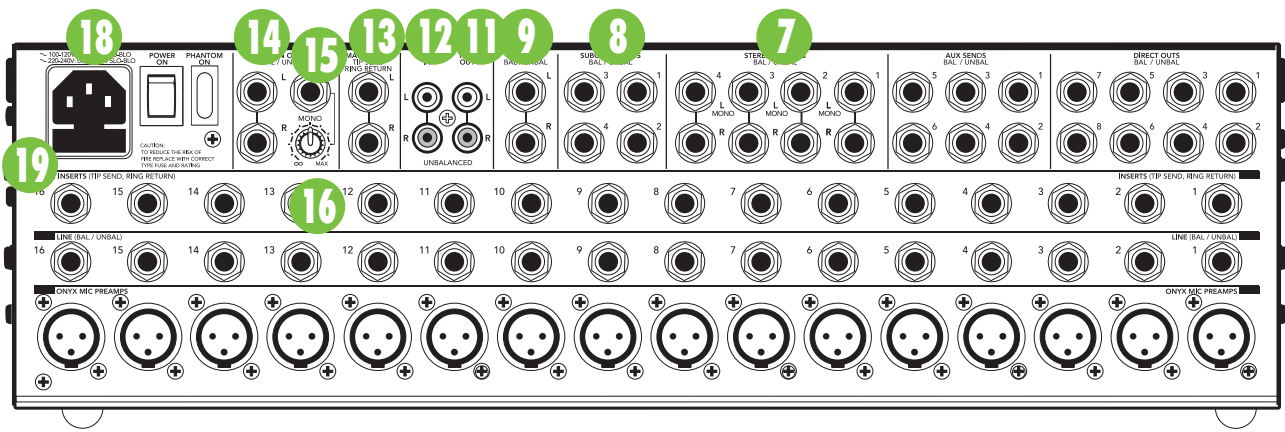

7. Stereo Returns

This is where to connect the outputs of parallel effects devices (or extra audio sources). They'll accept just about any pro or semipro effects device on the market. To learn how signals are routed from these inputs, see stereo return level [51] on page 23.

Mono: If you have an effects device with a mono output (one cord), plug that into the left input of a stereo return and leave the right input unplugged. That way, the signal will be sent to both sides, magically appearing in the center as a mono signal.

8. Sub Outs

These four 1/4" jacks are usually patched to the inputs of a multitrack deck, or to secondary amplifiers in a complex installation. To learn how signals are routed to these outputs, see subgroup faders [38], page 19.

Double Busing

How on earth do you get four jacks to feed eight tracks? To feed an 8-track deck with only four sub outs, simply use four Y-cords:

- Sub Out 1 feeds tracks 1 and 5
- Sub Out 2 feeds tracks 2 and 6
- Sub Out 3 feeds tracks 3 and 7
- Sub Out 4 feeds tracks 4 and 8

Tracks in record mode will accept the signal, and tracks in safe mode will ignore the signal. It's that easy.



This method is exactly the same as the double-busing feature found in other mixers. Built-in double-busing is nothing more than Y-cords living inside the mixer instead of hanging out the back. If we had room for the extra jacks, we would have thrown them in, but we don't, so we didn't. Sonically, there is no difference.

Y-cord advice: Do not use the stereo "headphone-to-left/right" splitter adapters. Use the type that send the same signal to two places; the tip of the source plug feeds the tips of both destination plugs.

9. C-R Outs (Control Room Outputs)

These 1/4" jacks are usually patched to the inputs of a control room amplifier or a headphone distribution amplifier. To learn how signals are routed to these outputs, see ctl room/phones [43] on page 20.

10. Phones Out (On Front Panel)

The 1604VLZ4's stereo 1/4" phones jack will drive any standard headphone to very loud levels. To learn how signals are routed to these outputs, see ctl room/phones [43] on page 20. If you're wiring your own cable for the phones output:

Tip = left channel
Ring = right channel
Sleeve = common ground

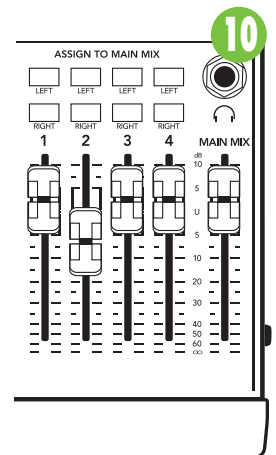

WARNING: When we say the headphone amp is loud, we're not kidding. It can cause permanent ear damage. Even intermediate levels may be painfully loud with some earphones.

BE CAREFUL! Always turn the ctl room/phones [43] knob all the way down before connecting headphones. Keep it down until you've put the phones on. Then turn it up slowly. Why? "Engineers who fry their ears find themselves with short careers."

11. Tape Out

These unbalanced RCA jacks tap the main mix outputs to make simultaneous recording and PA work more convenient. Connect these to your 2-track recorder's inputs. To learn how signals are routed to these outputs, see main mix [37] fader details on page 19.

Mono: If you want to feed a mono signal to your tape deck or other device, simply use the 1/4" mono [15] output jack.

12. Tape In

These unbalanced RCA jacks are designed to work with semipro as well as pro recorders. Connect your 2-track tape recorder's outputs here, using standard hi-fi RCA cables. To learn how signals are routed from these inputs, see tape in (level) [40] on page 20.

Use these jacks for convenient playback of mixes. You'll be able to review a mix, and then rewind and try another pass without repatching or disturbing the mixer levels. You can also use these jacks with a CD player to feed music to a PA system between sets.



WARNING: Pushing tape to main mix [41] in the output section can create a feedback path between tape input and tape output.

Make sure your tape deck is not in record, record-pause or input monitor mode when you engage this switch, or make sure the tape in level knob is fully counter-clockwise (off).

13. Main Insert

These 1/4" jacks are for connecting serial effects such as compressors, equalizers, de-essers, or filters. The insert point is after the mix amps, but before the main mix [37] fader. Insert cables must be wired thusly:

- Tip = send (output to effects device)
- Ring = return (input from effects device)
- Sleeve = common ground

14. Main Outs

These 1/4" jacks are usually patched to the inputs of your 2-track mixdown deck (unless you've chosen to use the tape output [11] RCA jacks), or to the house amplifier during live sound sessions. To learn how signals are routed to these outputs see main mix [37] fader details on page 19. To use these outputs to drive balanced inputs, connect 1/4" TRS (Tip-Ring-Sleeve) phone plugs like this:

- Tip = Positive (+ or hot)
- Ring = Negative (- or cold)
- Sleeve = Shield or ground

To use these outputs to drive unbalanced inputs, connect 1/4" TS (Tip-Sleeve) phone plugs like this:

- Tip = Positive (+ or hot)
- Sleeve = Shield or ground

15. Mono Out

It happens to everybody sooner or later: The forces that govern your world will demand a monaural output from your painstakingly-created stereo panorama. The last thing you want to do is start twirling all your carefully-placed pan settings to one side. What to do? Stick a cord in this 1/4" jack, hand the other end to Mr. Mono, and you're done. He's got his mono mix and you've still got your stereo mix. The mono output is nothing more than a mix of the left and right main mix.

16. Mono Level

So, Mr. Mono comes running back, screaming about the mono mix being so loud that his camcorder is melting. Just reach for this knob and turn it down a bit. Just the thing for sending mono signals to mic inputs like camcorders, telephone interface boxes, even answering machines. With the pot all the way up (fully clockwise), you'll have 6 dB of extra gain, with unity gain halfway between the one and two o'clock positions.

17. Voltage Selector

Located on the bottom panel, is a voltage selector switch.

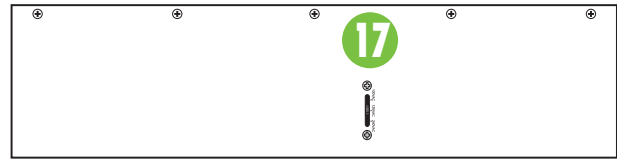

WARNING: Before you plug the AC power cord into the 1604VLZ4, you must make sure that this slide switch is set to the same voltage as the local AC mains supply. Only slide the voltage switch with the power cord unplugged.



Use a flat headed screwdriver to slide the switch if needed. The switch allows you to use the mixer in different countries and voltages, meet interesting people from other cultures, and entertain them.

18. Power Connection

Just in case you lose the cord provided with the 1604VLZ4, its power jack accepts a standard 3-prong IEC cord like those found on most professional recorders, musical instruments, and computers.



WARNING: Before you plug the AC power cord into the 1604VLZ4, you must make sure that the voltage selector [17] slide switch is set to the same voltage as the local AC mains supply.



WARNING: Disconnecting the plug's ground pin can be dangerous. Don't do it.

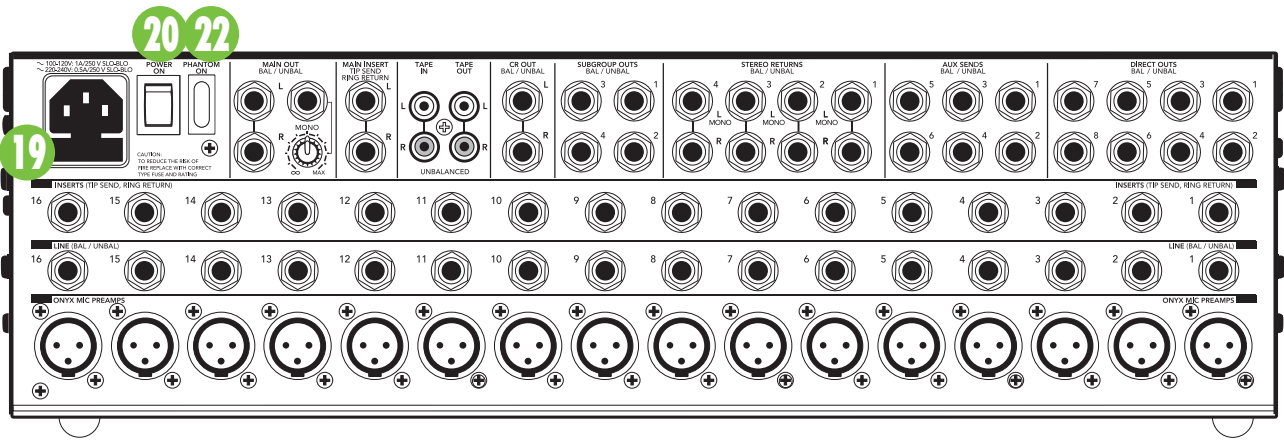

19. Fuse

The 1604VLZ4 is fused for your (and its own) protection. If you suspect a blown fuse, disconnect the power cord, pop out the fuse drawer with a small flat screwdriver, and replace the fuse with a 1A SLO BLO, 5x20mm, available at electronics stores or your dealer (or a 500 mA SLO BLO 5x20 mm if your 1604VLZ4 is set to 220V-240V).

If two fuses blow in a row, something is very wrong. Please call our toll-free number 1-800-898-3211 from within the U.S. (or call the distributor in your country) and find out what to do.

20. Power Switch

Press the top of this rocker switch inwards to turn on the mixer. The power led [21] on the top surface of the mixer will glow with happiness, or at least it will if you have the mixer plugged in to a suitable live AC mains supply.

Press the bottom of this switch to put the mixer into standby mode. It will not function, but the circuits are still live. To remove AC power, either turn off the AC mains supply, or unplug the power cord from the mixer and the AC mains supply.

As a general guide, you should turn the mixer on first, before the power amplifier or powered speakers, and turn it off last. This will reduce the possibilities of any turn-on, or turn-off thumps in the speakers.

21. Power LED

You've probably already figured this out, but if the power [20] switch is on, this LED (light-emitting diode), located in the output section, will light. If the switch is off, well, you get the idea. If the power switch is on and the LED does not glow, one of three things has happened: Somebody tripped over the power cord and yanked it from the outlet, your electricity has been turned off due to nonpayment, or the fuse has blown.

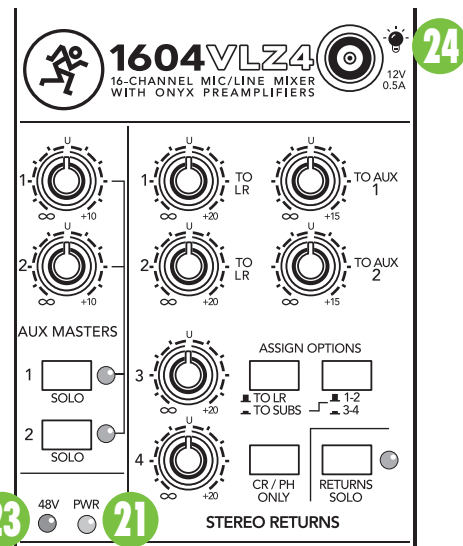

22. Phantom Switch

This switch controls the phantom power supply for all the mic [1] inputs, as discussed on page 9. When turned on (or off), the phantom power circuitry takes a few moments for voltage to ramp up (or down). This is perfectly normal. Make sure that you pull down the master fader, and headphone/control room volume before engaging the phantom switch.

23. 48V LED

Located right next to the power LED, this is just to let you know which way you have the phantom [22] switch set. If your dynamic mics work and your condensers don't, chances are this LED is off, so turn it on.

You'll notice that when you turn the phantom power off, the LED stays on for a while. This is a natural phenomenon — the LED is actually a voltmeter telling you that the phantom power takes time to ramp itself down to zero volts. So, if you've turned phantom power off to connect something to the mic inputs, wait until the LED stops glowing and then make your connections safely.

24. BNC Lamp Socket

Located in the top right corner of the output section, this 12V socket will drive any standard BNC-type lamp (a Littlite® #12G or #12G-HI (high-intensity), for instance).

Channel Strip Description

The 16 channel strips look alike and function identically. So if you learn one, you have learned them all. The only difference is that the eight on the left have direct out [5] jacks and the eight on the right don't. We'll start at the bottom and work our way up.

"U" Like Unity Gain

VLZ4 mixers have a "U" symbol on almost every level control. This "U" stands for "unity gain," meaning no change in signal level. Once you have performed the level-setting procedure, you can set every control at "U" and your signals will travel through the mixer at optimal levels. What's more, all the labels on our controls are measured in decibels (dB), so you'll know what you're doing level-wise if you choose to change a control's settings.

25. Channel Fader

The fader is almost the last control in a channel's signal path. It's placed after the EQ [32] and mute [30] controls (post-EQ /post-mute) and before the pan [31] control (pre-pan). The "U" mark, about three-quarters of the way up, indicates unity gain, meaning no increase or decrease of signal level. All the way up provides an additional 10 dB, should you need to boost a section of a song. If you find that the overall level is too quiet or too loud with a fader near unity, you'll want to confirm the setting by performing the level-setting procedure on page 5.

A Clean Fade

Faders are not rocket science — they operate by dragging a metal pin (the wiper) across a carbon-based strip (the track). It is possible for airborne crud to

land on the track. Should that happen, you may hear scratchy noises or signal dropouts as the wiper stumbles over the crud. Do all you can to keep airborne crud out of your profession. Use air-conditioned rooms whenever possible, avoid smoking near the mixer, keep food and drink away from the mixer, and for pity's sake, never put the mixer in your kitchen! We also recommend "exercising" the faders — give them a few full-travel excursions once a week or so, and that will help scare the crud away. Do not use spray cleaners, rather use compressed air, or a vacuum with brush attachment.

26. Assign (1-2, 3-4, L-R)

Alongside each channel fader are four buttons, labeled solo, 1-2, 3-4 and L-R. The latter three are collectively referred to as channel assignment switches. 1, 3 and L are the left sides of these stereo pairs, and 2, 4 and R are the right sides. Used in conjunction with the channel's pan [31] knob, these switches determine the destination of a channel's signal: With pan set at the center detent, the left and right sides receive equal signal levels. To feed only one side or the other, just turn the pan knob accordingly.

If you're doing a mixdown to a 2-track, simply engage the L-R switch on each channel that you want to hear, and they'll be sent to the main mix. If you want to create a subgroup of certain channels, engage either the 1-2 or 3-4 switches instead of the L-R, and they'll be sent to the appropriate subgroup faders. From there, the subgroups can be sent back to the main mix, allowing you to use the subgroup faders as a master control for those channels.

If you're printing new tracks or bouncing existing ones, you'll also use the 1-2 and 3-4 switches, but not the L-R switch. Here, you don't want the subgroups sent back into the main mix, but sent out, via the sub outs [8] jacks, to your multitrack inputs. However, if you're printing tracks via the direct out [5] jacks, all the channel assignment switches should be disengaged (up).

The 1604VLZ4 is what we call a "true 4-bus mixer." Each channel may be assigned or unassigned to any of the subgroups without affecting the other subgroups or settings within the channel, and each subgroup has its own master fader and dedicated output. In fact, since there are 4 subgroups and the main L/R mix, it's actually a true 6-bus mixer. We could have named it the 1606VLZ4. Darn!

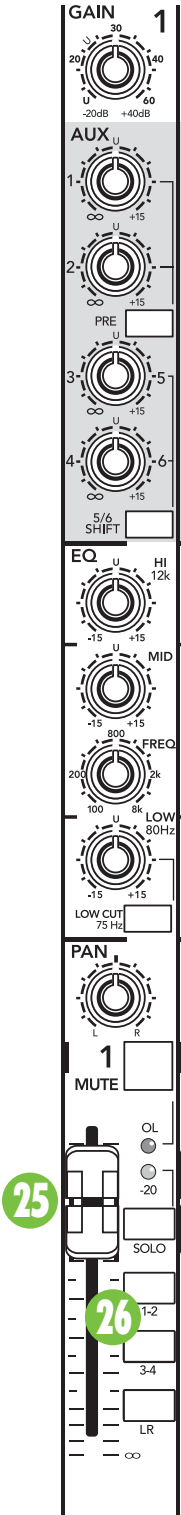

27. Solo

This lovable switch allows you to check signals in the phones or control room without having to assign them to the L-R, 1-2 or 3-4 mixes. You can solo as many channels as you like. Solo does not interrupt any of the other channels, buses or outputs — that’s called nondestructive solo.

Using the mode [44] switch, the 1604VLZ4’s solo system comes in two flavors: normal (AFL) (sometimes called SIP, or solo-in-place) and level set (PFL) (sometimes called PFL, or pre-fader-listen). The mode switch is described in tender loving detail on page 21.

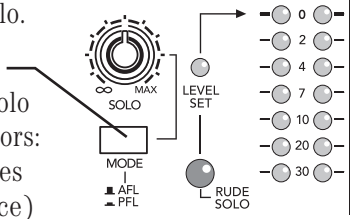

Level set (PFL) taps the channel signal before the fader. If you have a channel’s fader set way below “U” (unity gain), solo won’t know that and will send a unity gain signal to the control room, headphones, and meter display. That may result in a startling level boost at these outputs, depending on the position of the solo [46] level knob.

In a nutshell, soloed channels are sent to the source [42] mix, that ultimately feeds your control room, headphones and meter display. Whenever solo is engaged, all source selections (main mix, 1–2, 3–4, and tape) are defeated, to allow the soloed channel to do just that — solo!

28. -20 (Solo) LED

An LED that does two completely different things! Saves space, recycles the planet, but requires some explanation. First, the “-20” part: Often referred to as “signal activity,” this LED will flicker in time with the signal present in that channel. It’s handy for confirming that a channel is indeed active, and may also lend a clue as to what the signal is. For instance, a kick drum will cause the LED to pulse in time with the drum, and a synth pad will cause it to glow a bit more steadily.

Now for the “solo” part. When a channel’s solo switch is engaged, this LED will glow steadily, without flickering. It will also be brighter than it would be as a -20 indicator. In conjunction with the rude solo light [47], you can find a rogue solo switch quickly.

29. OL (Mute) LED

Another LED that does two completely different things! First, the “OL” part: “OL” means overload, or clip. You don’t want that to happen. Ever. Clipping can happen to any mixer — it’s the point where the signal’s voltage tries to exceed the supply voltages that power the circuitry. The 1604VLZ4’s OL LED will come on just before clipping, so if you see it, take immediate action: Perform the level-setting procedure on page 5. If that doesn’t help, check for excessive use of EQ boost or fader gain. Like the -20 LED, it will tend to flicker in time with that channel’s signal.

Now for the “mute” part. Assuming your levels are set correctly, the OL LED will never come on as a result of clipping. That’s pretty boring. So, to liven things up, this LED will glow steadily when that channel’s mute [30] switch is engaged.

Here is a quick reference to these LEDs:

Name	Color	Flickering	Glowing
-20 (SOLO)	green	signal present	channel soloed
OL (MUTE)	red	channel clipping	channel muted

30. Mute

Engaging this switch provides the same results as turning the channel’s fader all the way down: Any channel assignment to L-R, 1-2 or 3-4 will be interrupted. All the post aux sends will be silenced, as will the direct out signals on channels 1 through 8, and the OL (mute) LED will glow. The pre aux sends, channel insert send, and solo (in level set (PFL) mode) will continue to function during mute.

Depending on the audio content in a channel, engaging its mute switch may cause a slight popping sound. This is not a problem within the mixer, and it can be avoided: Simply engage the low cut [33] switch on each channel (unless its low frequency content is vitally important, such as a kick drum or bass guitar). Low cut eliminates subsonic debris, which causes the pop, and its effect is usually transparent.

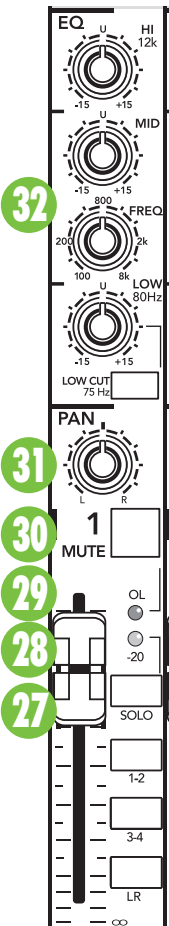

31. Pan

This adjusts the amount of channel signal sent to the left versus the right outputs. Pan determines the fate of the L-R assignment, subgroups 1–2 and 3–4, and the solo (in AFL mode). With the pan knob hard left, the signal will feed the left main mix, subgroup 1, subgroup 3 and left normal (AFL) solo mode (assuming their assignment switches are engaged). With the knob hard right, signal feeds the right main mix, subgroup 2, subgroup 4 and right normal (AFL) solo mode. With pan set somewhere in-between left and right, the signal will be divided between the left and right buses.

Stereo Sources

Your life will be easier if you follow this standard convention: When patching stereo sound sources to a mixer, always plug the left signal into an “odd” channel (1, 3, 5, etc.) and the right signal into the adjacent “even” channel (2, 4, 6, etc.). Then pan the odd channel hard left and the even channel hard right.

Constant Loudness !!!



The 1604VLZ4's pan controls employ a design called “Constant Loudness.” It has nothing to do with living next to a freeway. As you turn the pan knob from left to right (thereby causing the sound to move from the left to the center to the right), the sound will appear to remain at the same volume (or loudness).

If you have a channel panned hard left (or right) and reading 0 dB, it must dip down about 4 dB on the left (or right) when panned center. To do otherwise, like those Brand X mixers, would make the sound appear much louder when panned center.

32. 3-Band Mid-Sweep EQ

The 1604VLZ4 has a 3-band, mid-sweep equalization: low shelving at 80 Hz, mid sweep peaking from 100 Hz to 8 kHz, and hi shelving at 12 kHz. It's probably all the EQ you'll ever need! (Shelving means that the circuitry boosts or cuts all frequencies past the specified frequency. For example, the 1604VLZ4's low EQ boosts bass frequencies below 80 Hz and continuing down to the lowest note you never heard. Peaking means that certain frequencies form a “hill” around the center frequency.)

The low EQ provides up to 15 dB boost or cut below 80 Hz. The circuit is flat (no boost or cut) at the center detent position. This frequency represents the punch in bass drums, bass guitar, fat synth patches, and some really serious male singers who eat broken glass for breakfast.

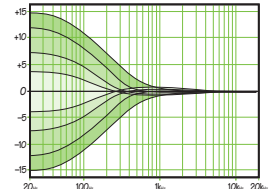

Used in conjunction with the low cut [33] switch, you can boost the low EQ without injecting a ton of subsonic debris into the mix. We recommend using the low cut feature on all channels, except low frequency signals, like kick drums and bass guitars.

The mid EQ, or “midrange,” has a fixed bandwidth of 1 octave. The mid knob sets the amount of boost or cut, up to 15 dB, and is effectively bypassed at the center detent. The frequency knob sets the center frequency, sweepable from 100 Hz to 8 kHz.

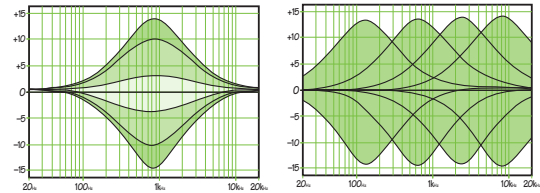

Most of the root and lower harmonics that define a sound are located in the 100 Hz–8 kHz frequency range, and you can create drastic changes with these two knobs. Many engineers use mid EQ to cut midrange frequencies, not boost them. One popular trick is to set the mid fully up, turn the frequency knob until you find a point where it sounds just terrible, then back the mid down into the cut range, causing those terrible frequencies to disappear. Sounds silly, but it works. Sometimes.

The hi EQ provides you up to 15 dB boost or cut above 12 kHz, and it is also flat at the detent. Use it to add sizzle to cymbals, an overall sense of transparency, or an edge to keyboards, vocals, guitar and bacon frying. Turn it down a little to reduce sibilance or to mask tape hiss.

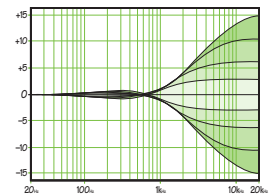

With too much EQ, you can screw things up royally. We've designed a lot of boost and cut into each equalizer circuit because we love you, and know that everyone will occasionally need that. But if you max the EQ on every channel, you'll get mix mush. Equalize subtly and use the left sides of the knobs (cut), as well as the right (boost). If you find yourself repeatedly using full boost or cut, consider altering the sound source, such as placing a mic differently, trying a different kind of mic, changing the strings, or gargling.

33. Low Cut

This switch, often referred to as a high pass filter (all depends on how you look at it), cuts bass frequencies below 75 Hz at a rate of 18 dB per octave. This ain't no thrown-in dime-store filter — an 18 dB per octave curve requires an elaborate circuit. Nothing but the best.

We recommend that you use this on every sound source except kick drum, bass guitar, or bassy synth patches. These aside, there isn't much down there that you want to hear, and filtering it out makes the low stuff you do want much more crisp and tasty. Not only that, but low cut can help reduce the possibility of feedback in live situations, and it helps to conserve amplifier power.

With low cut, you can safely boost low EQ. Many times, bass shelving EQ can really benefit voices. Trouble is, adding low EQ also boosts the subsonic debris: Stage rumble, mic handling clunks, wind noise and breath pops. Low cut removes all that debris so you can boost the low EQ without blowing your subwoofers.

Here's a frequency curve of low EQ combined with low cut:

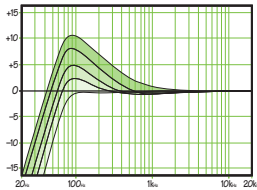

34. Aux 1, 2, 3, & 4

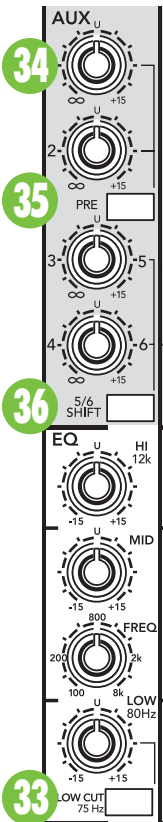

These four knobs tap a portion of each channel's signal, mix them together and send them to the aux send [6] outputs. They are off when turned fully down, deliver unity gain at the center detent, and can provide up to 15 dB of gain turned fully up. Chances are you'll never need this extra gain, but it's nice to know it's there if you do.

The aux send outputs are then patched to parallel effects processor inputs or stage monitor amp inputs. Aux sends 1 and 2 levels are controlled not only by the channel's aux knobs, but also by the aux send [49] master knobs.

Aux sends can also be used to generate separate mixes for recording or "mix-minuses" for broadcast. By using aux 1 or 2 in the pre [35] mode, these mix levels can be obtained independently of a channel's fader [25] settings.



We recommend going into a stereo reverb in mono and returning in stereo. We have found that on most "stereo" reverbs, the second input just ties up an extra aux send and adds nothing to the sound. There are exceptions, so feel free to try it both ways. Should you choose to use two aux sends, use the "odd" aux (1, 3 or 5) to feed its left input and the "even" aux (2, 4 or 6) to feed the right input. Remember, if you're also dealing with a stereo source signal, you'll want to follow the sides — use the odd aux on the channel carrying the left side and the even aux on the channel carrying the right.

35. Pre

This switch determines the tap point of aux 1 and 2. Generally, "post" sends are used to feed effects devices, and "pre" sends are used to feed your stage monitors. See the "Pre vs. Post" diagram below. Aux 3 through 6 are always in post mode.

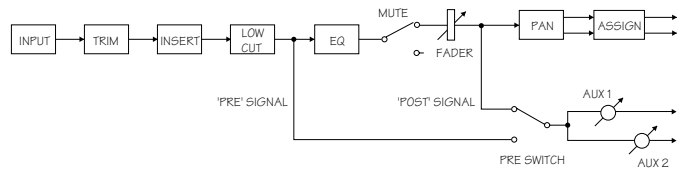

In post mode (switch up), aux 1 and 2 will follow the EQ [32], low cut [33], fader [25], and mute [30] settings. If you fade the channel, you fade the send. This is a must for effects sends, since you want the levels of your "wet" signals to follow the level of the "dry."

In pre mode (switch down), aux 1 and 2 follow the gain and low cut settings only. EQ, pan, fader, and mute settings have no effect on the pre sends. This is the preferred method for setting up stage monitor feeds — they'll be controlled independently of the fader and mute moves.

36. 5/6 Shift

Don't let the fact that there's only four aux knobs per channel fool you — the 1604VLZ4 has six aux sends [6]. With this 5/6 shift switch up, the knobs labeled aux 3 and aux 4 deliver their signals to aux send 3 and 4 outputs. With this switch down, the signals appear at the aux send 5 and 6 outputs.

We recommend that aux send 3 and 4 be patched into your "utility" effects, like a short reverb and slap delay; effects you use all the time. Use aux send 5 and 6 for "exotic" effects, like harmonizers and multi-tap delays; they are not likely to be used as often.

Output Section Description

You've just learned about the input channels and how the signals get in and out. The signals come in via mic [1] and line [2] input jacks, are manipulated by the channels, and then sent to the output (master) section. Things get a little more complicated, so put on your thinking caps, take a deep cleansing breath, take this manual, get on a bicycle, ride down to the canal, ponder your life and all its unique experiences, then read this section.

37. Main Mix Fader

This fader controls the levels of signals sent to the main out [14] jacks and tape output [11] RCA jacks. All channels and stereo returns that are assigned to the main mix, not muted and not turned fully down will appear at the main outs. Before the main mix gets to this fader, the signals pass through the main insert [13].

The main mix signals are off with the fader fully down, the "U" marking is unity gain, and fully up provides 10 dB additional gain. This additional gain will typically never be needed, but once again, it's nice to know it's there. The fader itself is a stereo version of the channel and subgroup faders — same supersmooth custom taper, same dead silence when turned fully down. This is the fader to pull down at the end of the song when you want "The Great Fade-Out."

38. Subgroup Faders

As you might expect, these faders control the levels of signals sent to the sub outs [8]. All channels that are assigned to subgroups with the assign [26] switches, not muted and not turned fully down will appear at the sub outs. Unlike the main out [14], the subgroup signals do not pass through an insert jack on their way to the subgroup faders. That's no problem — should you want to send these signals through a serial effects processor, simply patch from the sub outs to the effect's input, and from the effect's output to whatever the final destination is, usually a multitrack recorder.

The subgroup signal is off when its fader is fully down, the "U" marking is unity gain, and fully up provides 10 dB additional gain. Remember that if you're treating two subgroups as a stereo pair, subgroup 1 and 2 for example, make sure that both subgroup faders "ride" together, to maintain the left/right balance.

39. Assign To Main Mix

One popular use of the subgroups is to use them as master faders for a group of channels on their way to the main mix. Let's say you've got a drum kit hogging up seven channels and you're going to want to fade them out at a different rate than the other channels. You don't want to try that with seven hands or seven fingers, so just un-assign these channels from L-R, reassign them to subgroup 1-2, engage the assign to main mix, left on subgroup 1 and the assign to main mix, right on subgroup 2. Now you can ride the entire stereo drum mix with two faders — 1 and 2.

If you engage just one assign to main mix switch per subgroup (left or right), the signal sent to the main mix will be the same level as the sub outs [8]. If you want the subgroup to appear in the center of the main

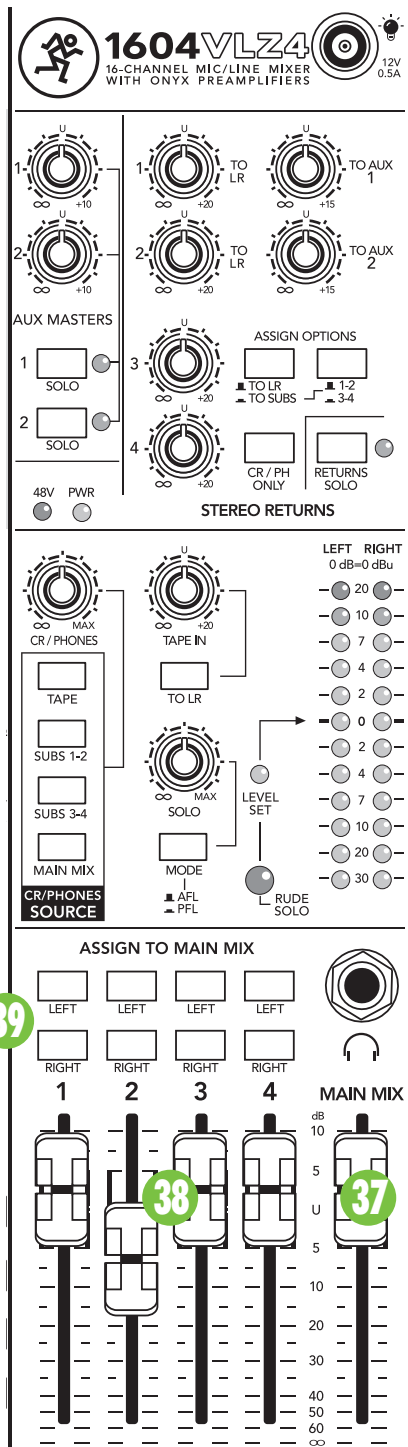

mix, engage both the assign to main mix, left and right switches. The signal will be sent to both sides, and will be attenuated just enough to preserve constant loudness, just like the channel pan [31] knobs when set in the center.

40. Tape In (Level)

This knob controls the level of the stereo signal coming from the tape input [12] RCA jacks. Its range is off when fully down, unity at the center detent, with 20 dB additional gain turned fully up, which may come in handy if you've patched in a device with wimpy output levels. After the level is determined, the stereo tape signal can be sent to either of two places — the main mix or the source [42] matrix.

41. Tape To LR

Engaging this switch is just like engaging the L-R switch on a channel — the signal, stereo in this case, is sent to the main mix. It does not interrupt other signals, just adds itself to them. This switch can be very handy in a live sound situation when you want to play soothing elevator music to an anxious crowd.



WARNING: Engaging tape to main mix can create a feedback path between tape input [12] and tape output [11]. Make sure your tape deck is not in record, record-pause or input monitor mode when you engage this switch, or that the tape in [40] level knob is turned fully down.

42. Source

Typically, the engineer sends the main mix to an audience or to a mixdown deck (if recording). But what if the engineer needs to hear something other than the main mix? With the 1604VLZ4, the engineer has several choices of what to listen to. This is one of those tricky parts — have a double espresso first.

Using these switches, you can choose to listen to any combination of main mix, subs 1-2, subs 3-4 and tape. Selections made here deliver stereo signals to the control room, headphones, and meter display. These signals are tapped off as follows — post-main mix fader, post subgroup faders [38], and post-tape in [40] knob. With no switches engaged, there will be no signal at these outputs and no meter indication, with two exceptions: solo and stereo return 4.

Regardless of the source matrix selection, engaging a solo switch will replace that selection with the solo signal, also sent to the control room, headphones, and meter display. This is what makes the level-setting procedure so easy.

Now you know how to select the signals you want to send to the engineer's control room and/or phones. Once selected, these signals all pass through the same level control, aptly named:

43. CR/Phones

As you might expect, this knob controls the levels of both the stereo control room, and the headphones. Make sure that you move it to minimum before selecting or adding a new source.

Whatever your selection, you can also use the control room outputs for other applications. The sound quality is just as impeccable as the main outputs. It can be used as an additional main mix output and this one will have its own level control. However, should you do this, be aware that if you engage a solo [27] switch, that will interrupt the mix:

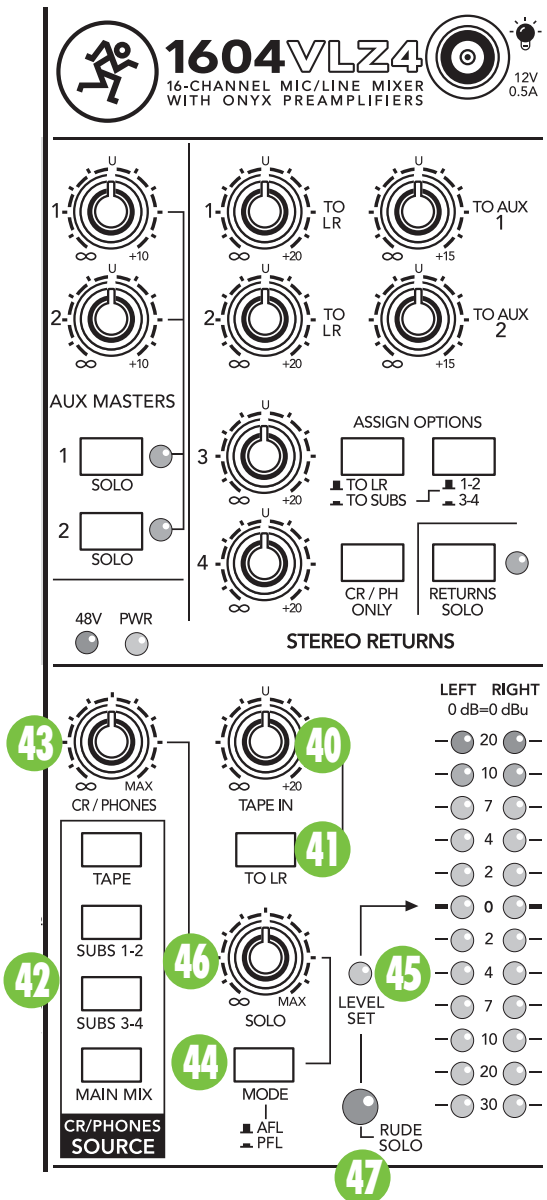

Engaging a solo switch will cause this dramatic turn of events: Any existing source matrix selections will be replaced by the solo signals, appearing in the control room, headphones and meter display. The audible solo levels are controlled by the solo [46] level knob. The solo levels appearing on the meter display are not controlled by anything — you wouldn't want that. You want to see the actual channel level on the display, regardless of how loud you're listening.

44. Mode (AFL/PFL)

The 1604VLZ4's solo system comes in two flavors: AFL (sometimes called SIP, or solo-in-place) and PFL (sometimes called PFL, or pre-fader-listen).

In AFL, the soloed channel's signal is sent directly to the control room, headphones and meter display just as it would sound to the channel's assignment switches: post-EQ [32], post-fader [25] and post-pan [31]. The only difference is that solo works regardless of the channel's assignment positions, and that makes it really handy — you can check out a channel before you assign it.

AFL is the preferred mode during mixdown: If the channel has some midrange boost at 4.236kHz, is panned a smidgen to the left, and its fader is at -5.385dB , that's exactly what you'll hear if you solo during AFL mode. It's just as if you took the time to mute all the other channels.

PFL solo is the key player in the all-important level-setting procedure. It'll send the channel's actual internal levels to the meters so you'll know just what's going on, level-wise. This procedure should be performed every time a new sound source is patched into a channel's mic [1] or line [2] input jacks.

PFL is also the preferred mode for SR (sound reinforcement, or live sound), to preview channels before they are let into the mix. It won't give you stereo placement, but will give you signal even if the fader is turned down.



Remember, PFL taps the channel signal before the fader. If you have a channel's fader set way below "U" (unity gain), solo won't know that and will send a unity gain signal to the control room, headphones, and meter display. That may result in a startling level boost at these outputs, depending on the position of the solo [46] level knob.

45. Level Set LED

When the mode switch [44] is engaged, it's in PFL mode, the mode you must be in to set levels. Now, when you engage any solo switch, this LED will be a "green light" to set levels. If you tried to set levels during AFL mode, the meter display would be at the mercy of the channel fader, and that would be a big problem.

46. Solo (Level)

This knob controls the level of the signals coming from the solo system. After the solo level is determined, the solo signals will proceed to take over the control room, headphones, and meter display.



Once again, PFL solo taps the channel signal before the fader. If you have a channel's fader set way below "U" (unity gain), PFL solo won't know that and will send a unity gain signal to the control room, headphones, and meter display. This may result in a startling level boost at these outputs, depending on the position of the solo level knob.

47. Rude Solo Light

This flashing LED (light emitting diode) serves two purposes — to remind you that you're in solo, and to let you know that you're mixing on a 1604VLZ4. No other company is so concerned about your level of solo awareness. We even force the soloed channel's -20 LED to play along, so you can find that rogue switch fast.

If you work on a mixer that has a solo function with no indicator lights, and you happen to forget you're in solo, you can easily be tricked into thinking that something is wrong with your mixer. Hence the rude solo light. It's especially handy at about 3:00 in the morning, when no sound is coming out of your monitors, even though your multitrack is playing back like mad.

48. Meters

The 1604VLZ4's peak metering system is made up of two columns of twelve LEDs. Deceptively simple, considering the multitude of signals that can be monitored by it. If nothing is selected in the source [42] matrix, and no channels are in solo [27], the meter display will just sit there. To put them to work, you must make a selection in the source matrix (or engage a channel's solo switch).

Why? You want the meter display to reflect what the engineer is listening to, and as we've covered, the engineer is listening either to the control room output or the headphones. The only difference is that while the listening levels are controlled by the CR/phones [43] knob, the meter display reads the source mix before that control, giving you the real facts at all times, even if you're not listening at all.

When the solo mode [44] switch is set to PFL (down), all soloed signals will be sent to the left meter only. That, combined with the level set LED [45], are along the path of enlightenment known as the level-setting procedure (page 5). During AFL mode, the meters will behave normally.

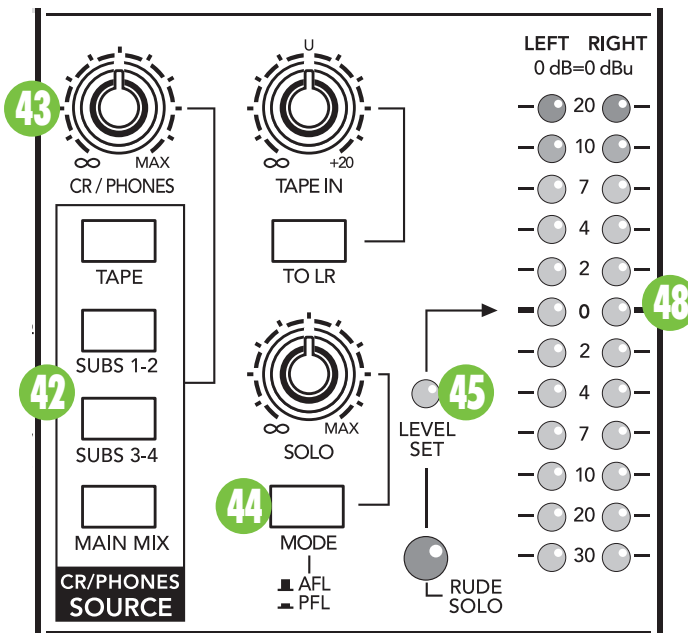

Meters vs. Reality

You may already be an expert at the world of “+4” (+4 dBu=1.23 V) and “-10” (-10 dBV=0.32 V) operating levels. Basically, what makes a mixer one or the other is the relative 0 dB VU (or 0 VU) chosen for the meter display. A “+4” mixer, with a +4 dBu signal pouring out the back will actually read 0 VU on its meter display. A “-10” mixer, with a -10 dBV signal trickling out, will read, you guessed it, 0 VU on its meter display. So when is 0 VU actually 0 dBu? Right now!

At the risk of creating another standard, VLZ4 compact mixers address the need of both crowds by calling things as they are: 0 dBu (0.775 V) at the output shows as 0 VU on the meter display. What could be easier? By the way, the most wonderful thing about standards is that there are so many to choose from.

Thanks to the 1604VLZ4's wide dynamic range, you can get a good mix with peaks flashing anywhere between -20 and +10 dB on the meter display. Most amplifiers clip at about +10 dB, and some recorders aren't so forgiving either. For best real-world results, try to keep your peaks between “0” and “+7.”

Please remember: Audio meter displays are just tools to help assure you that your levels are “in the ballpark.” You don't have to stare at them (unless you want to). If you find that staring at the meters sends you into a hypnotic trance, please do not be alarmed. Just cut my lawn and polish my car every Tuesday.

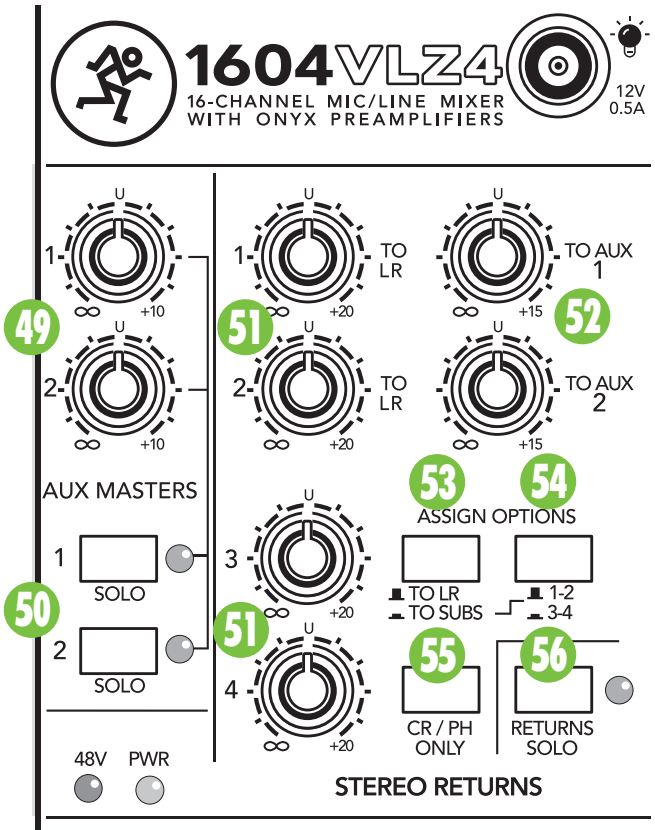

Aux Talk

Sends are outputs, returns are inputs. Each channel's aux [34] knobs tap the signal off the channel and send it to the aux send [6] outputs. Aux 1 and 2 are sent to the aux sends 1 and 2 [49] master knobs before the aux send outputs; aux 3 through 6 are sent directly.

These outputs can be fed to the inputs of a reverb or other device. From there, the outputs of the external device are fed back to the mixer's stereo return [7] inputs. Then these signals are sent through the stereo return [51] level controls, and finally delivered to the main mix.

So, the original “dry” signals come from the channels to the main mix, and the affected “wet” signals come from the stereo returns to the main mix, and once mixed together, the dry and wet signals combine to create a glorious sound. Armed with this knowledge, let's visit the Auxiliary World:

49. Aux Sends (Master)

These knobs provide overall level control of aux sends 1 and 2, just before they're delivered to their aux send [6] outputs. This is perfect for controlling the level of stage monitors, since you'll be using aux 1 and 2 for this, with their pre [35] switches engaged. Aux sends 3 through 6 have no such control — they'll just send their mixes directly to their respective aux send outputs at unity gain.

These knobs go from off (turned fully down), to unity gain at the center detent, with 10 dB of extra gain (turned fully up). As with some other level controls, you may never need the additional gain, but if you ever do, you'll be glad you bought a 1604VLZ4.

This is usually the knob you turn up when the lead singer glares at you, points at his stage monitor, and sticks his thumb in the air. (It would follow suit that if the singer stuck his thumb down, you'd turn the knob down, but that never happens.)

50. Aux Sends Solo

Once again, in live sound situations aux send 1 and 2 are likely to feed your stage monitors. You'll want to check the mix you're sending them, and that's what these two buttons are for. (Aux 3 through aux 6 have no such switch.) Beside each switch is a green LED that, just like the channel's -20 LED [28], helps you find the rogue solo switch.

The only thing different about aux sends solo is that it's not really PFL (pre-fader listen), and it's not really SIP (solo-in-place), it's actually AFL (after-fader listen). During AFL [44] mode, you'll get aux send 1's solo signal, post-aux sends [49] master level, in the left side of the control room outputs, phones output and meter display, and aux send 2 on the right side. (If you ever use aux 1 and 2 to create a stereo monitor mix, you'll understand why.) In PFL mode, you'll get the signal dead-center, but still post-aux sends master level.

51. Stereo Returns (Level)

These four controls set the overall level of effects received from the stereo return [7] input jacks. These controls are designed to handle a wide range of signal levels — each knob goes from off, to unity gain at the detent, to 20 dB gain fully clockwise, to compensate for low-level effects. Signals passing through these level controls will proceed directly to the main mix fader [37], with exceptions that we'll discuss in a moment.

Typically, these knobs can just live at the center detent, and the effects device's output control should be set at whatever they call unity gain (check their manual). If that turns out to be too loud or too quiet, adjust the effects device's outputs, not the mixer. That way, the mixer's knobs are easy to relocate at the center detent.

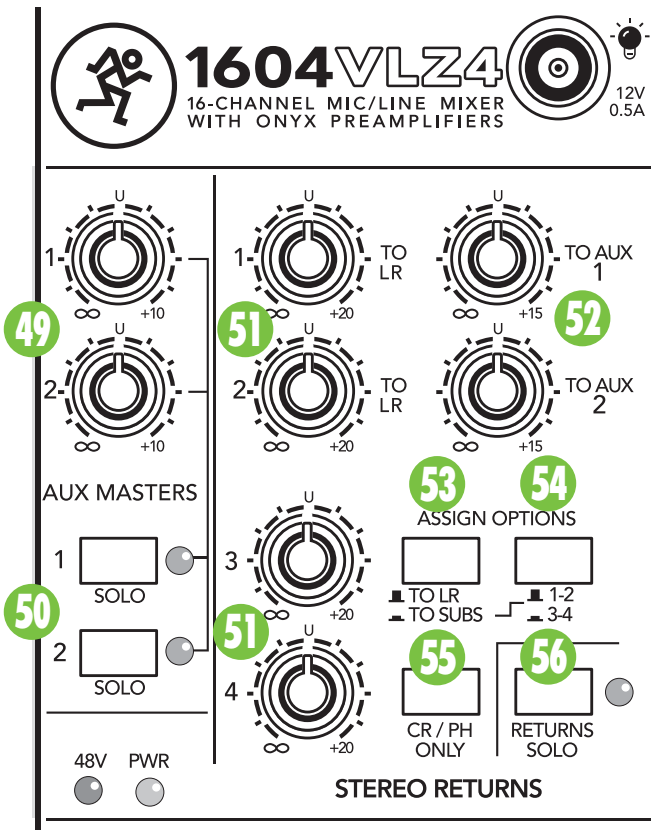

52. To Aux 1 and To Aux 2

If you want to add reverb or delay to the stage monitor mixes, these are the knobs for you. Operating independently of their respectively numbered stereo returns [51] level controls, these knobs are exactly the same as the channel strip aux 1 [34] and aux 2 knobs.

These two knobs feed stereo return signals to their respective aux send [6] outputs:

To aux send 1 feeds stereo return 1 to aux send 1 master, and:

To aux send 2 feeds stereo return 2 to aux send 2 master.

They are off when turned fully down, deliver unity gain at the center detent, and can provide up to 15 dB of gain turned fully up. Stereo return 3 and 4 have no such knobs.

53. Main Mix To Subs (Stereo Return 3)

With this switch up, stereo return 3 behaves like all the others — it delivers a stereo signal, regulated by its level knob, to the main mix. When you engage this switch, the signals are removed from the main mix buses and sent to the 1-2/3-4 switch, which diverts the signal once more. We're not finished. Please read on.

54. 1-2/3-4 (Stereo Return 3)

If the main mix to subs [53] switch is disengaged, this switch does absolutely nothing. Let's now assume it's engaged. Stereo return 3's stereo signal will not be sent to the main mix, but to subgroup faders 1 and 2 (this switch up) or subgroup faders 3 and 4 (this switch down).

Let's say you've made a stereo drum submix on subgroup faders 1 and 2, so you can ride those two faders instead of the seven channels that the drums came from. Subgroup fader 1 has its assign to main mix [39], left button engaged and subgroup fader 2 has its assign to main mix, right button engaged, blending the drum submix back into the main mix. The drum channels are also sending signals to your reverb via the aux sends [6], and the reverb outputs are patched into stereo return 3 [7]. So far so good.

Even though you could send stereo return 3 directly to the main mix (main mix to subs [53] switch up), you don't want to. Instead, engage the main mix to subs switch and make sure the 1-2/3-4 switch is up. Now the reverb return will be blended into the drum submix, and as you ride those two faders, the reverb level will follow.

Why do we want that? Because if you had just sent the reverb directly to the main mix (main mix to subs switch up) and you did a drum fade-out using subgroup faders 1 and 2, the "dry" signals would fade out, but the "wet" signals would keep on singing. All you would hear is the drum reverb (the "wet"), and none of the original drum signals (the "dry"). That's because the reverb is being fed by the channel's aux sends, and they have no idea that you've pulled down the subgroup faders. That's why we threw in these switches, phew!

55. CR/PH Only (Stereo Return 4)

Once again, the default for all the stereo returns is to feed them directly into the main mix. You've just learned about the optional exceptions involving stereo return 3.

Stereo return 4 also has an optional exception: By engaging this switch, you will remove stereo return 4's stereo signal from the main mix and send it directly to the CR/phones source [42] matrix. It matters not if any of the source matrix switches are assigned, but it will be interrupted, as usual, if a solo [27] switch is engaged.

Let's pretend you're doing a live mix to a 2-track deck, a house PA, or both, and you want to play along to a click track. You could run the click track directly into the main mix, but you don't want the mixdown deck and/or audience to hear it. By gum, this is the switch for you. Similarly, it can be used for voice-over tracks, narration, anything you want heard by the engineer and players but not by the audience and mixdown deck.

56. Returns Solo and LED

This switch operates just like the channel solo [27] switches — engaging it sends signals to the control room, headphones, and meter display, and interrupts whatever happened to be there before you soloed. It follows the mode [44] switch setting as well. The only difference is that when you engage this returns solo switch, it sends all four stereo returns signals to the solo circuit.

Assume you want to solo the snare drum. Hit that channel's solo switch, and you get the "dry" (no effects) snare only. That helps, but you want to hear it with the reverb you have patched into a stereo return. Leaving that channel's solo switch engaged, also engage the returns solo switch, and now you'll get the dry snare and its reverb.

Since it is a global feature, you'll also get the signals from all the other stereo returns, so there may be some sounds that you didn't want to hear. If they offend your sensibilities, simply turn down the levels of the stereo returns you don't want to hear, or mute the channels feeding the unwanted signal to the effects device you do want to hear.

Congratulations! You've just read about all the features of your 1604VLZ4. You're probably ready for a cold one. Go ahead. The rest of the manual can wait.

Appendix A: Service Information

Warranty Service

If you think your 1604VLZ4 has a problem, please check out the following troubleshooting tips and do your best to confirm the problem. Visit the Support section of our website (www.720trees.com) where you will find lots of useful information such as FAQs and other documentation. You may find the answer to the problem without having to send your mixer away.

Troubleshooting

Bad Channel

- Are the channels assigned to the correct mix (1-2, 3-4, L-R)?
- Is the fader up?
- Try unplugging any insert devices from the insert jacks.
- Try the same source signal in another channel, set up exactly like the suspect channel.

Bad Output

- Is the level control (if any) turned up?
- If you're listening to the CR outs or phones outputs, has a source selection been made?
- If it's one of the main outs, try unplugging its companion. For example, if it's the 1/4" left main out, unplug the RCA output. If the problem goes away, it's not the mixer.
- If it's a stereo pair, try switching them around. For example, if a left output is presumed dead, switch the left and right cords, at the mixer end. If the problem stays on the left, it's not the mixer.
- Unplug everything from the main inserts.

Noise

- Turn the channel faders and stereo return knobs down, one by one. If the sound disappears, it's either that channel or whatever is plugged into it, so unplug whatever that is. If the noise disappears, it's from your whatever.

Power

- Unplug the power cord and check the fuse.

Repair

For warranty service, refer to the warranty information on page 35.

Non-warranty service is available at a factory-authorized service center. To locate the nearest service center, visit www.720trees.com, click "Contact Tech Support" and select "Locate a Service Center or Distributor" [3]. Service for a 1604VLZ4 living outside the United States may be obtained through local dealers or distributors.

If you do not have access to our website, you can call our Tech Support department at 1-800-898-3211, Monday-Friday, normal business hours, Pacific Time, to explain the problem. Tech Support will tell you where the nearest factory-authorized service center is located in your area.

Appendix B: Connections

Balanced XLR Input Connector

The 1604VLZ4 mixer has 16 female XLR inputs. Be sure the cables are wired per AES (Audio Engineering Society) standards:

Balanced XLR Input Connector

- Pin 1 – Shield (Ground)
- Pin 2 – Positive (+ or hot)
- Pin 3 – Negative (– or cold)

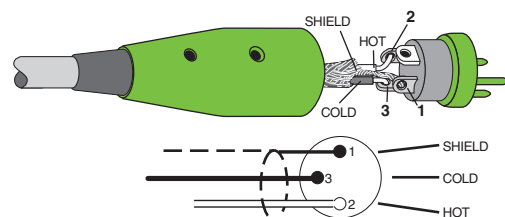

Balanced XLR Input Connector

Balanced XLR Output Connector

The male XLR connectors provide a balanced line-level signal that represents the end of the mixer, where the fully mixed stereo signal enters the real world. Connect these to the left and right line-level inputs of powered speakers or to the left and right line-level inputs of an amplifier (with speakers already attached). Be sure the cables are wired per AES (Audio Engineering Society) standards:

Balanced XLR Output Connector

- Pin 1 – Shield (Ground)
- Pin 2 – Positive (+ or hot)
- Pin 3 – Negative (– or cold)

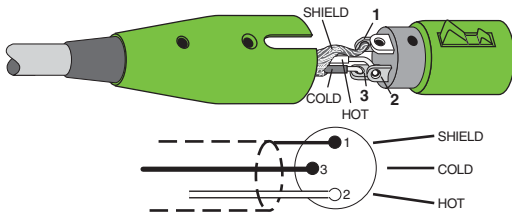

Balanced XLR Output Connector

Balanced 1/4" TRS Connector

TRS stands for Tip-Ring-Sleeve, the three connections available on a stereo 1/4" cable. This allows for a direct connection to the channel input jacks. Be sure the cables are wired per AES (Audio Engineering Society) standards:

Balanced 1/4" TRS Connector

- Sleeve – Shield (Ground)
- Tip – Positive (+ or hot)
- Ring – Negative (– or cold)

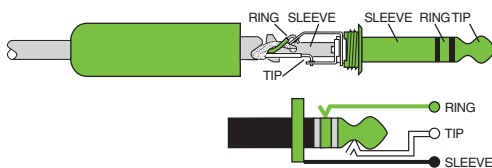

Balanced 1/4" TRS Connector

TRS jacks and plugs are used in several different applications:

- Balanced mono circuits. When wired as a balanced connector, a 1/4" TRS jack or plug is connected tip to signal high (hot), ring to signal low (cold), and sleeve to ground (earth).
- Stereo Headphones, and rarely, stereo microphones and stereo line connections. When wired for stereo, a 1/4" TRS jack or plug is connected tip to left, ring to right and sleeve to ground (earth). VLZ4 mixers do not directly

accept 1-plug-type stereo microphones. They must be separated into a left cord and a right cord, which are plugged into the two mic preamps.

You can cook up your own adapter for a stereo microphone. "Y" two cables out of a female 1/4" TRS jack to two male XLR plugs, one for the right signal and one for the left.

- Unbalanced send/return circuits. When wired as a send/return "Y" connector, a 1/4" TRS jack or plug is connected tip to signal send (output from mixer), ring to signal return (input back into mixer), and sleeve to ground (earth).

Unbalanced 1/4" TS Connector

TS stands for Tip-Sleeve, the two connections available on a mono 1/4" cable. This allows for a direct connection to the channel input jacks. Be sure the cables are wired per AES (Audio Engineering Society) standards:

Unbalanced 1/4" TS Connector

- Sleeve – Shield (Ground)
- Tip – Positive (+ or hot)

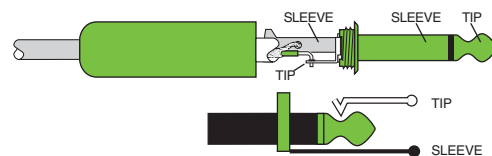

Unbalanced 1/4" TS Connector

TS jacks and plugs are used in many different applications, always unbalanced. The tip is connected to the audio signal and the sleeve to ground (earth). Some examples:

- Unbalanced microphones
- Electric guitars and electronic instruments
- Unbalanced line-level connections

Switched 1/4" Phone Jacks

Switches can be incorporated into 1/4" phone jacks, which are activated by inserting the plug. These switches may open an insert loop in a circuit, change the input routing of the signal or serve other functions. The 1604VLZ4 uses switches in the channel insert and bus insert jacks, input jacks and stereo returns. It also uses these switches to ground the line-level inputs when nothing is plugged into them.

In most cases, the plug must be inserted fully to activate the switch. The 1604VLZ4 takes advantage of this in some circuits, specifying circumstances where you are to insert the plug only partially. See "Special Connections", on the next page.

Unbalanced RCA Connector

RCA-type plugs (also known as phono plugs) and jacks are often used in home stereo and video equipment and in many other applications. RCA plugs are unbalanced. Connect the signal to the center post and the ground (earth) or shield to the surrounding "basket." Be sure the cables are wired per AES (Audio Engineering Society) standards:

Unbalanced RCA Connector

Sleeve – Shield (Ground)
Tip – Positive (+ or hot)

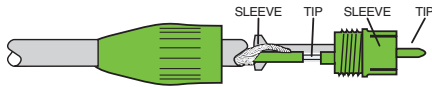

Unbalanced RCA Connector

Unbalancing a Line

In most studio, stage and sound reinforcement situations, there is a combination of balanced and unbalanced inputs and outputs on the various pieces of equipment. This usually will not be a problem in making connections.

- When connecting a balanced output to an unbalanced input, be sure the signal high (hot) connections are wired to each other, and that the balanced signal low (cold) goes to the ground (earth) connection at the unbalanced input. In most cases, the balanced ground (earth) will also be connected to the ground (earth) at the unbalanced input. If there are ground-loop problems, this connection may be left disconnected at the balanced end.
- When connecting an unbalanced output to a balanced input, be sure that the signal high (hot) connections are wired to each other. The unbalanced ground (earth) connection should be wired to the low (cold) and the ground (earth) connections of the balanced input. If there are ground-loop problems, try connecting the unbalanced ground (earth) connection only to the input low (cold) connection, and leaving the input ground (earth) connection disconnected.
- In some cases, you will have to make up special adapters to interconnect your equipment. For example, you may need a balanced XLR female connected to an unbalanced 1/4" TS phone plug.

TRS Send/Receive Insert Jacks

Single-jack inserts are three-conductor, TRS-type 1/4" phone. They are unbalanced, but have both the mixer output (send) and the mixer input (return) signals in one connector. See the illustration below.

The sleeve is the common ground (earth) for both signals. The send from the mixer to the external unit is carried on the tip, and the return from the unit to the mixer is on the ring.

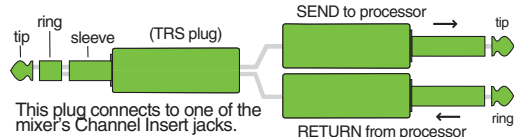

Unbalanced 1/4" Insert Connectors

Special Connections

The balanced-to-unbalanced connection has been anticipated in the wiring of 1604VLZ4 jacks. A 1/4" TS plug inserted into a 1/4" TRS balanced input, for example, will automatically unbalance the input and make all the right connections. Conversely, a 1/4" TRS plug inserted into a 1/4" unbalanced input will automatically tie the ring (low or cold) to ground (earth).

Using the Send Only on an Insert Jack

If you insert a TS (mono) 1/4" plug only partially (to the first click) into a VLZ4 insert jack, the plug will not activate the jack switch and will not open the insert loop in the circuit (thereby allowing the channel signal to continue on its merry way through the mixer).

This allows you to tap out the channel or bus signal without interrupting normal operation.

If you push the 1/4" TS plug in to the second click, you will open the jack switch and create a direct out, which does interrupt the signal in that channel. See the illustration on the next page.

NOTE: Do not overload or short-circuit the signal you are tapping from the mixer. That will affect the internal signal.

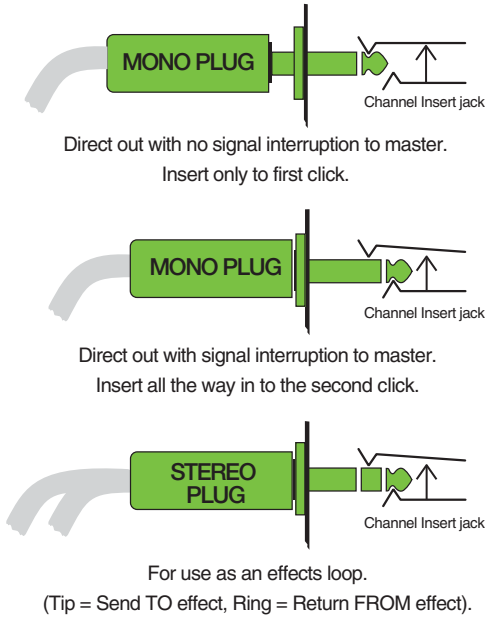

Using the Send Only on an Insert Jack

VLZ4 Stereo Inputs and Returns: Mono, Stereo, Whatever

Stereo line inputs and stereo returns are a fine example of our philosophy (which we just made up) of Maximum Flexibility with Minimum Headache. The inputs and returns will automatically be mono or stereo, depending upon how you use the jacks. Here's how it works:

A mono signal should be patched into the input or return jack labeled left (mono). The signal will be routed to both the left and right sides of the return circuit, and will show up in the center of the stereo pair of buses it's assigned to, or it can be panned with the pan [26] control.

A stereo signal, having two plugs, should be patched into the left (mono) and the right input or return jacks. A jack switch in the right jack will disable the mono function, and the signals will show up in stereo.

A mono signal connected to the right jack will show up in the right bus only. You probably will only want to use this sophisticated effect for special occasions.

Mults and "Y"s

A mult or "Y" connector allows you to route one output to two or more inputs by simply providing parallel wiring connections. You can make "Y"s and mults for the outputs of both unbalanced and balanced circuits.



Remember: Only mult or "Y" one output into several inputs. If you need to combine several outputs into one input, you must use a mixer, not a mult or a "Y."

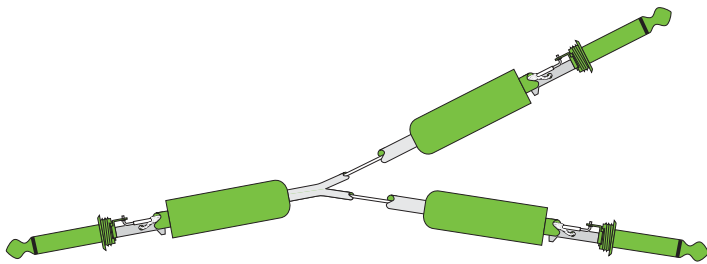

Y-cord splitter cable

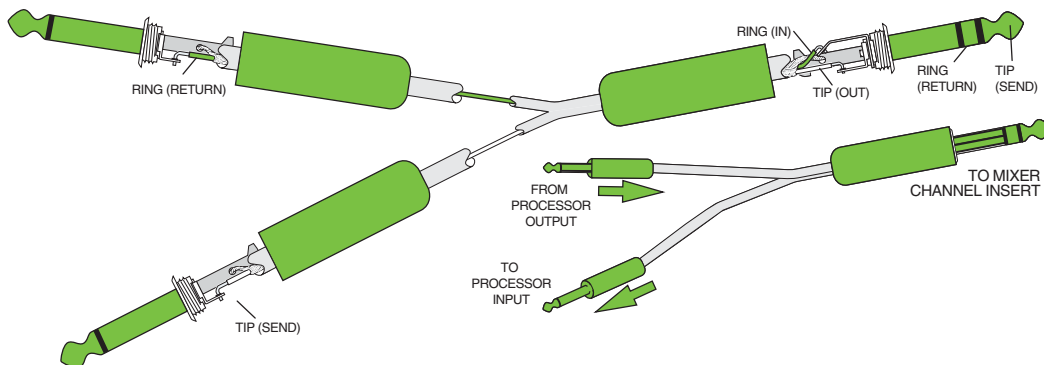

Y-cord insert cable

Appendix C: Technical Information

Specifications

Main Mix Noise

(20 Hz–20 kHz bandwidth, 1/4" Main out, channel gains @ unity gain, channel EQs flat, all channels assigned to Main Mix, odd channels panned left, even channels panned right.)

Main Mix fader unity, channel faders down: –88.5 dBu
(92 dB Signal to Noise Ratio, ref +4 dBu)

Main Mix fader unity, channel faders @ unity: –82.5 dBu

Total Harmonic Distortion (THD)

(1 kHz 35 dB gain, 20 Hz–20 kHz bandwidth)

Mic in to insert send: <0.0007%

Mic in to Main Out: <0.005%

Attenuation (Crosstalk)

(1 kHz relative to 0 dBu, 20 Hz–20 kHz bandwidth, Line in, 1/4" Main Out, Gain @ unity.)

Channel Mute switch engaged: –84 dBu

Channel Gain knob down: –84 dBu

Frequency Response

Mic Input to Main Output (Gain @Unity)

+0, –1 dB, 20 Hz to 50 kHz

+0, –3 dB, <10 Hz to >100 kHz

Equivalent Input Noise (EIN)

(Mic in to Insert Send out, max gain.)

150 Ω termination: –128.5 dBu

Common Mode Rejection Ratio (CMRR)

(Mic in to Insert Send out, max gain.)

1 kHz: better than –70 dB

Maximum Levels

Mic in: +22 dBu

All other inputs: +22 dBu

Main Mix TRS out: +28 dBu

All other outputs: +22 dBu

Impedances

Mic in: 2.5 k Ω

Channel Insert return: 2.5 k Ω

All other inputs: 10 k Ω or greater

Tape out: 1.1 k Ω

All other outputs: 120 Ω

EQ

High Shelving ± 15 dB @ 12 kHz

Mid Peaking ± 15 dB sweep 100 Hz–8 kHz

Low Shelving ± 15 dB @ 80 Hz

Low Cut Filter 18 dB/octave, –3 dB @ 75 Hz

Power Consumption

50 watts

Fuse Ratings

100–120 VAC 1A Slo Blo, 5 x 20 mm

220–240 VAC 0.5A Slo Blo, 5 x 20 mm

Dimensions (H x W x D) in Normal Pod Position

17.0" x 17.3" x 5.1" (433 mm x 440 mm x 129 mm)

Weight

20.0 lb (9.1 kg)

Since we are always striving to improve our products by incorporating new and improved materials, components, and manufacturing methods, we reserve the right to change these specifications at any time without notice.

The "Running Man" figure is a registered trademark of LOUD Technologies Inc. All other brand names mentioned are trademarks or registered trademarks of their respective holders, and are hereby acknowledged.

The technical writer responsible for this manual tends to fade in and out of various different realities, depending on how many cups of tea he has had. Please check our website for any updates to this manual: www.720trees.com.

©2013 LOUD Technologies Inc. All Rights Reserved.

Dimensions

10 Rack Spaces

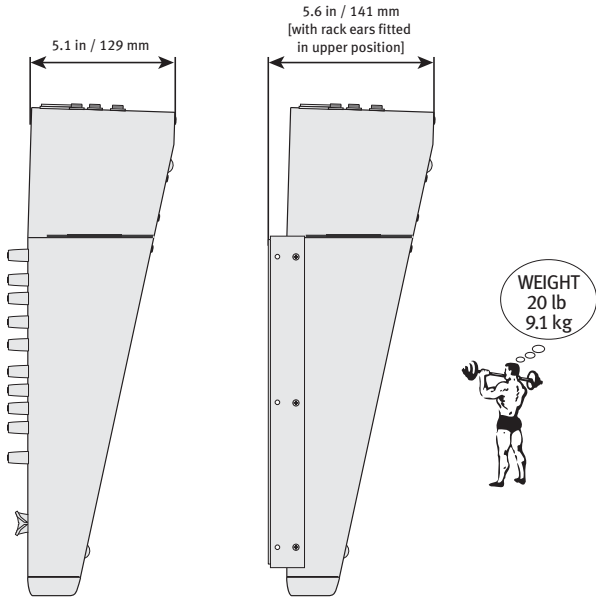
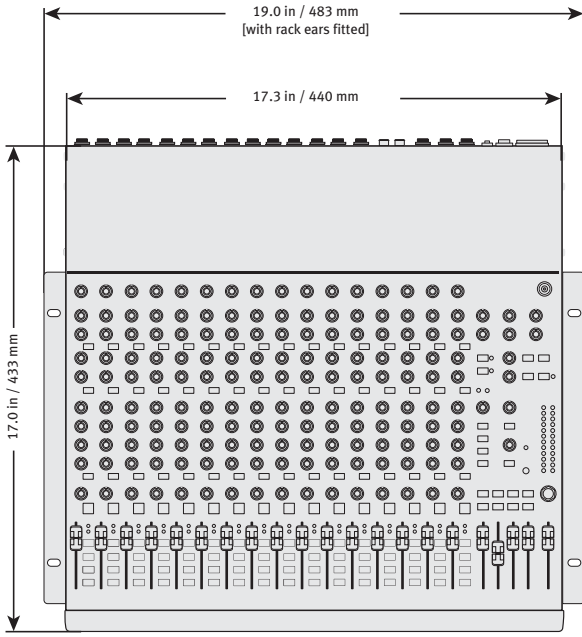

Pod in normal position

8 Rack Spaces

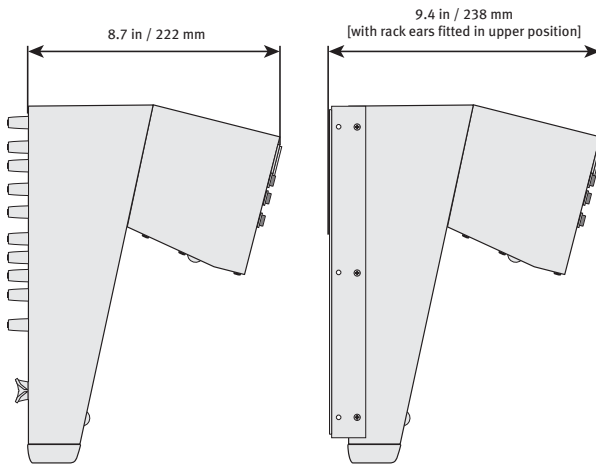
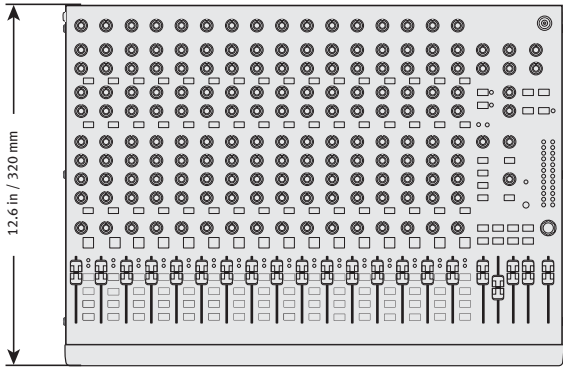

Pod in back position

11 Rack Spaces

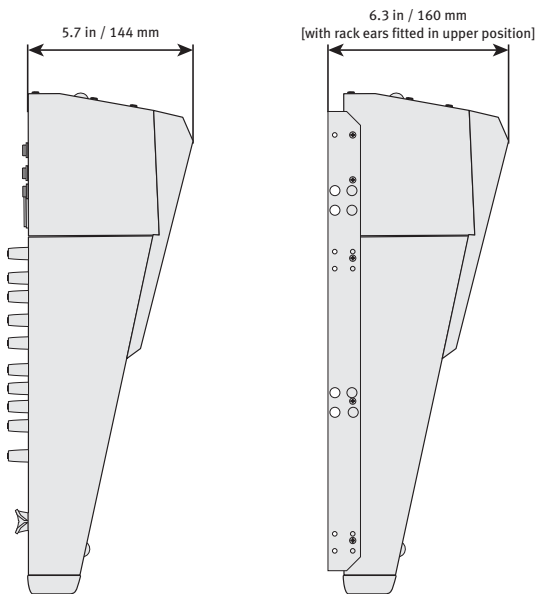
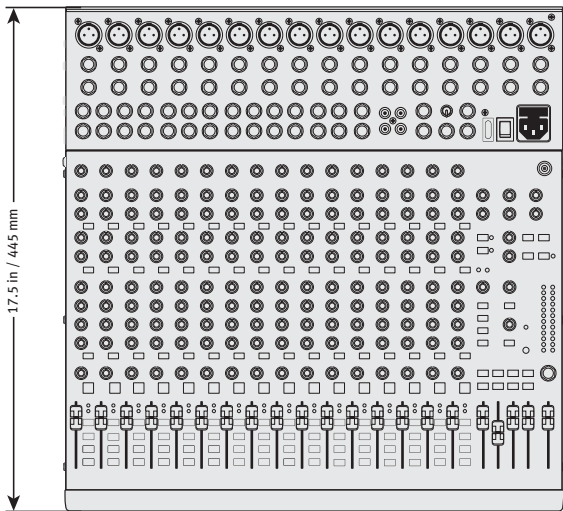

Pod in front (with optional RotoPod)

Track Sheet

Session: _____

Date: _____

Notes: _____

	1	2	3	4	5	6	7	8	9	10	G
GAIN											
AUX											
	<input type="checkbox"/> PRE	<input type="checkbox"/> PRE	<input type="checkbox"/> PRE	<input type="checkbox"/> PRE	<input type="checkbox"/> PRE	<input type="checkbox"/> PRE	<input type="checkbox"/> PRE	<input type="checkbox"/> PRE	<input type="checkbox"/> PRE	<input type="checkbox"/> PRE	
	<input type="checkbox"/> 5/6 SHIFT	<input type="checkbox"/> 5/6 SHIFT	<input type="checkbox"/> 5/6 SHIFT	<input type="checkbox"/> 5/6 SHIFT	<input type="checkbox"/> 5/6 SHIFT	<input type="checkbox"/> 5/6 SHIFT	<input type="checkbox"/> 5/6 SHIFT	<input type="checkbox"/> 5/6 SHIFT	<input type="checkbox"/> 5/6 SHIFT	<input type="checkbox"/> 5/6 SHIFT	
EQ											
	<input type="checkbox"/> LOW CUT 75 Hz	<input type="checkbox"/> LOW CUT 75 Hz	<input type="checkbox"/> LOW CUT 75 Hz	<input type="checkbox"/> LOW CUT 75 Hz	<input type="checkbox"/> LOW CUT 75 Hz	<input type="checkbox"/> LOW CUT 75 Hz	<input type="checkbox"/> LOW CUT 75 Hz	<input type="checkbox"/> LOW CUT 75 Hz	<input type="checkbox"/> LOW CUT 75 Hz	<input type="checkbox"/> LOW CUT 75 Hz	
PAN											
	<input type="checkbox"/> MUTE	<input type="checkbox"/> MUTE	<input type="checkbox"/> MUTE	<input type="checkbox"/> MUTE	<input type="checkbox"/> MUTE	<input type="checkbox"/> MUTE	<input type="checkbox"/> MUTE	<input type="checkbox"/> MUTE	<input type="checkbox"/> MUTE	<input type="checkbox"/> MUTE	
	<input type="checkbox"/> 1-2	<input type="checkbox"/> 1-2	<input type="checkbox"/> 1-2	<input type="checkbox"/> 1-2	<input type="checkbox"/> 1-2	<input type="checkbox"/> 1-2	<input type="checkbox"/> 1-2	<input type="checkbox"/> 1-2	<input type="checkbox"/> 1-2	<input type="checkbox"/> 1-2	
	<input type="checkbox"/> 3-4	<input type="checkbox"/> 3-4	<input type="checkbox"/> 3-4	<input type="checkbox"/> 3-4	<input type="checkbox"/> 3-4	<input type="checkbox"/> 3-4	<input type="checkbox"/> 3-4	<input type="checkbox"/> 3-4	<input type="checkbox"/> 3-4	<input type="checkbox"/> 3-4	
	<input type="checkbox"/> LR	<input type="checkbox"/> LR	<input type="checkbox"/> LR	<input type="checkbox"/> LR	<input type="checkbox"/> LR	<input type="checkbox"/> LR	<input type="checkbox"/> LR	<input type="checkbox"/> LR	<input type="checkbox"/> LR	<input type="checkbox"/> LR	

GAIN 11 **GAIN 12** **GAIN 13** **GAIN 14** **GAIN 15** **GAIN 16**

AUX 1 **AUX 2** **AUX 3** **AUX 4**

EQ HI 12k MID FREQ 800 200 100 8k LOW 80Hz LOW CUT 75 Hz

PAN **MUTE**

SOLO **1-2** **3-4** **LR**

1604VLZ4
16-CHANNEL MIC/LINE MIXER
WITH ONYX PREAMPLIFIERS

12V 0.5A

AUX MASTERS **ASSIGN OPTIONS**

STEREO RETURNS

CR/PHONES SOURCE

ASSIGN TO MAIN MIX

MAIN MIX dB 10 5 5 10 20 30 40 50 60 80

Block Diagram

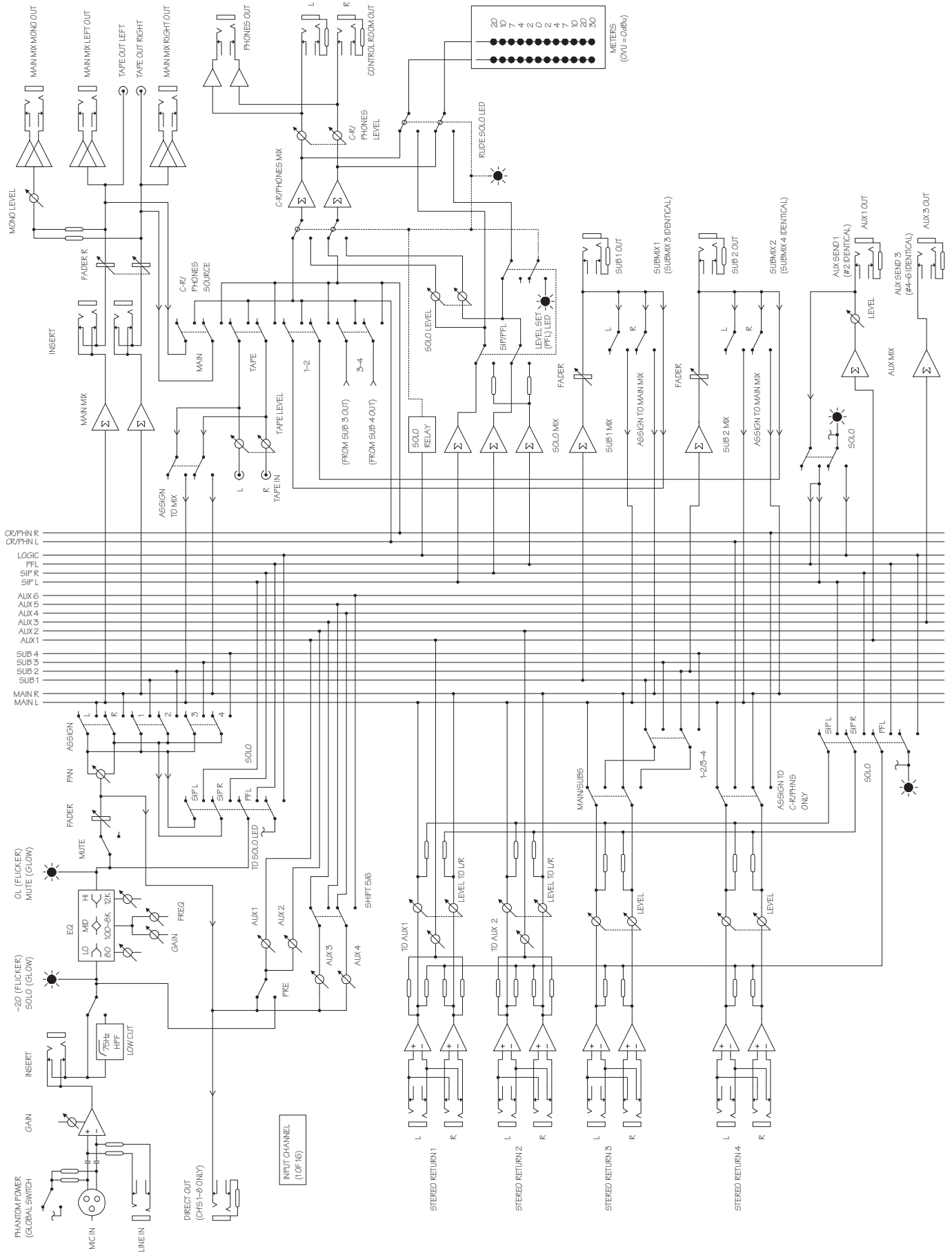

1604VLZ4 Limited Warranty

Please keep your sales receipt in a safe place.

This Limited Product Warranty ("Product Warranty") is provided by LOUD Technologies Inc. ("LOUD") and is applicable to products purchased in the United States or Canada through a LOUD-authorized reseller or dealer. The Product Warranty will not extend to anyone other than the original purchaser of the product (hereinafter, "Customer," "you" or "your").

For products purchased outside the U.S. or Canada, please visit www.720trees.com to find contact information for your local distributor, and information on any warranty coverage provided by the distributor in your local market.

LOUD warrants to Customer that the product will be free from defects in materials and workmanship under normal use during the Warranty Period. If the product fails to conform to the warranty then LOUD or its authorized service representative will at its option, either repair or replace any such nonconforming product, provided that Customer gives notice of the noncompliance within the Warranty Period to the Company at: www.720trees.com or by calling LOUD technical support at 1.800.898.3211 (toll-free in the U.S. and Canada) during normal business hours Pacific Time, excluding weekends or LOUD holidays. Please retain the original dated sales receipt as evidence of the date of purchase. You will need it to obtain any warranty service.

For full terms and conditions, as well as the specific duration of the Warranty for this product, please visit www.720trees.com.

The Product Warranty, together with your invoice or receipt, and the terms and conditions located at www.720trees.com constitutes the entire agreement, and supersedes any and all prior agreements between LOUD and Customer related to the subject matter hereof. No amendment, modification or waiver of any of the provisions of this Product Warranty will be valid unless set forth in a written instrument signed by the party to be bound thereby.



16220 Wood-Red Road NE
Woodinville, WA 98072 • USA
Phone: 425.487.4333
Toll-free: 800.898.3211
Fax: 425.487.4337
www.720trees.com
